

# BOX DOCCIA CON SISTEMA SCORREVOLE

SHOWER BOX WITH SLIDING SYSTEM / DUSCHKABINE MIT SCHIEBETÜRSYSTEM



**BX-DIV5000**  
(OPTIONAL SOFT-CLOSE)



► 18

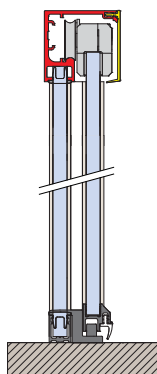

**BX-5000 TINY**  
(OPTIONAL SOFT-CLOSE)



► 48

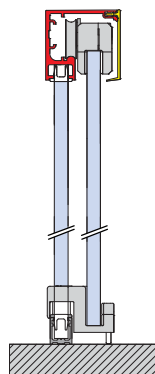

**BX-4000 LINEA 30**

► 60

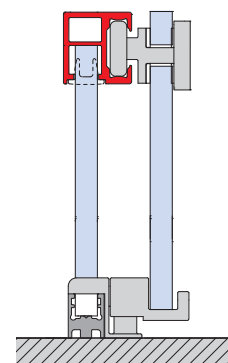



**BX-6050  
PURA**

► 72

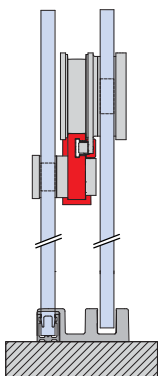

**BX-6000**

**BX-6020  
SOFT-CLOSE**



► 82

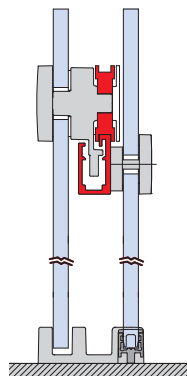

**BX-1501**

► 98

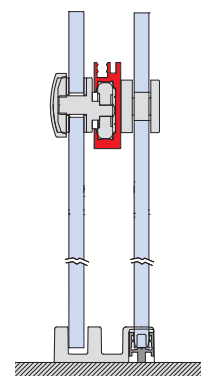

SCORREVOLI

# GUIDA TECNICA PER LA SCELTA DEL TUO "PROFILO A TERRA" SECONDO TIPOLOGIE

## TECHNICAL GUIDE FOR THE CHOICE OF YOUR "FLOOR PROFILE" BY TYPOLOGIES

### AUSWAHL VON "BODENPROFIL" NACH VORHANDENEN KRITERIEN

Per i modelli: / For models: / Für Modelle:  
**BX-1501, BX-4000, BX-6000, BX-6020,**  
**BX-5000, BX-6050, BX-DIV5000**

#### SET 1

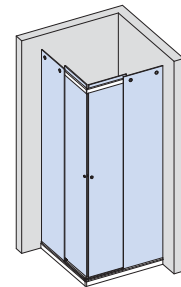

#### BX-PT-01 STANDARD

- Vetro fisso nel profilo continuo H 16 mm.
- Fixed glass in shower entry floor profile H 16 mm.
- Festverglasung im Duscheinstieg Bodenprofil H 16 mm.

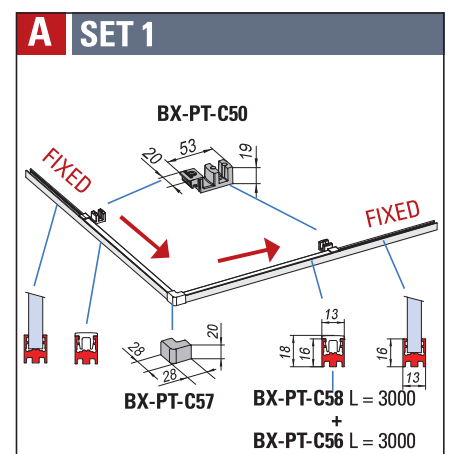
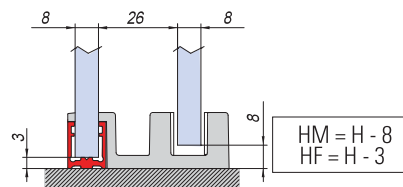

#### BX-PT-02 SOLO PORTA OPTIONAL

- Vetro fisso su piatto doccia, solo profilo entrata H 16 mm.
- Fixed glass on shower tray, only shower entry floor profile H 16 mm.
- Festverglasung auf Duschtasse, Duscheinstieg Bodenprofil H 16 mm.

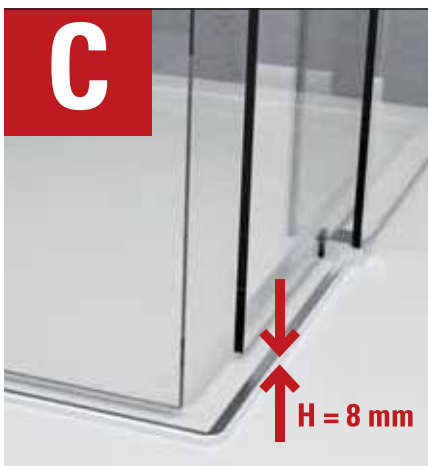
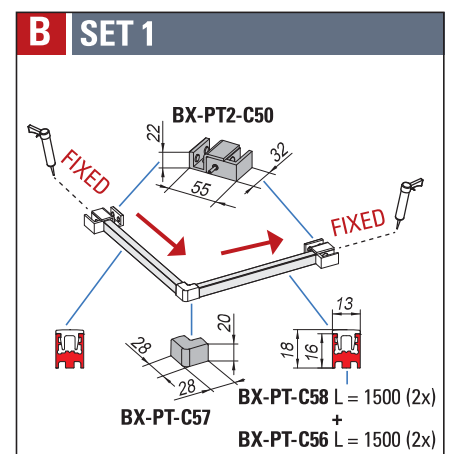
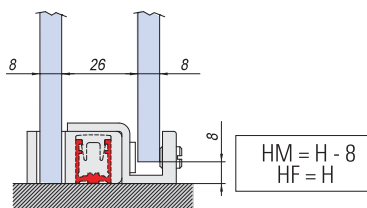

#### BX-PT-03 RASO DOCCIA OPTIONAL

- Vetro fisso su piatto doccia, profilo entrata H 8 mm.
- Fixed glass on shower tray, shower entry floor profile H 8 mm.
- Festverglasung auf Duschtasse, Duscheinstieg Bodenprofil H 8 mm.

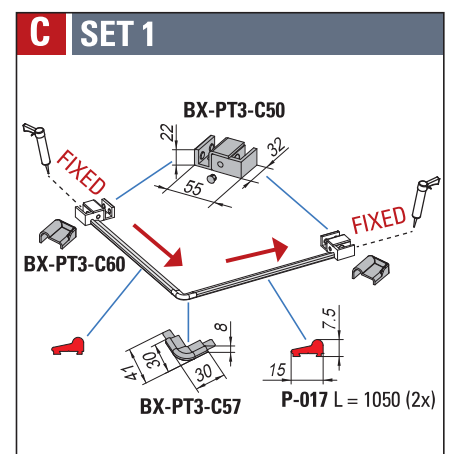
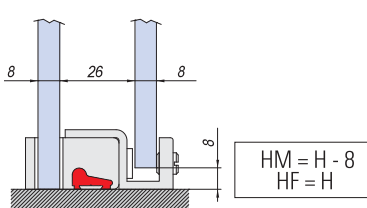

SCORREVOLI

# SCEGLIERE FONDO PREFERITO

CHOOSE FAVORITE FLOOR PROFILES / WÄHLEN SIE IHR GEWÜNSCHTES BODENPROFIL

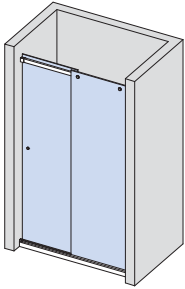
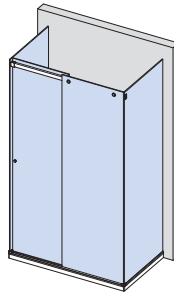
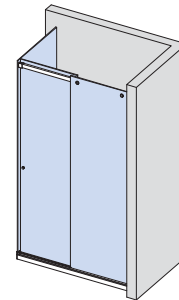
**SET 2**

**SET 3**

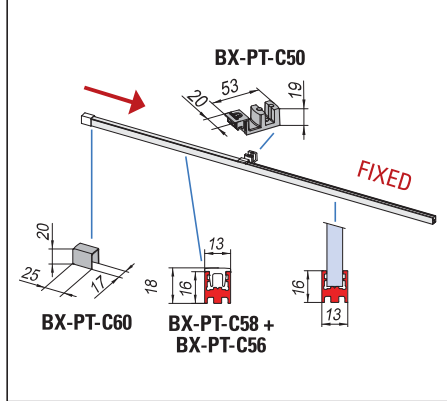
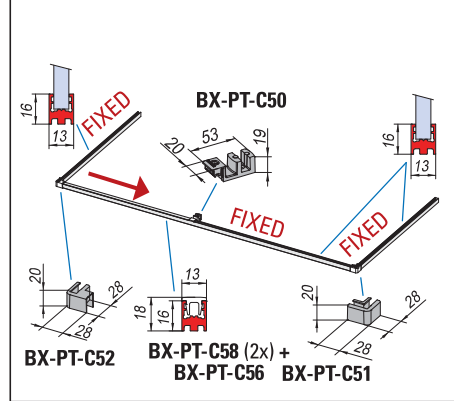
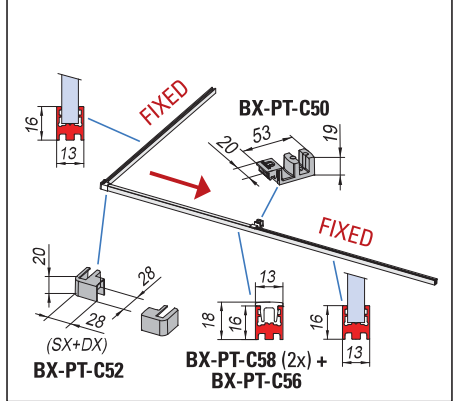
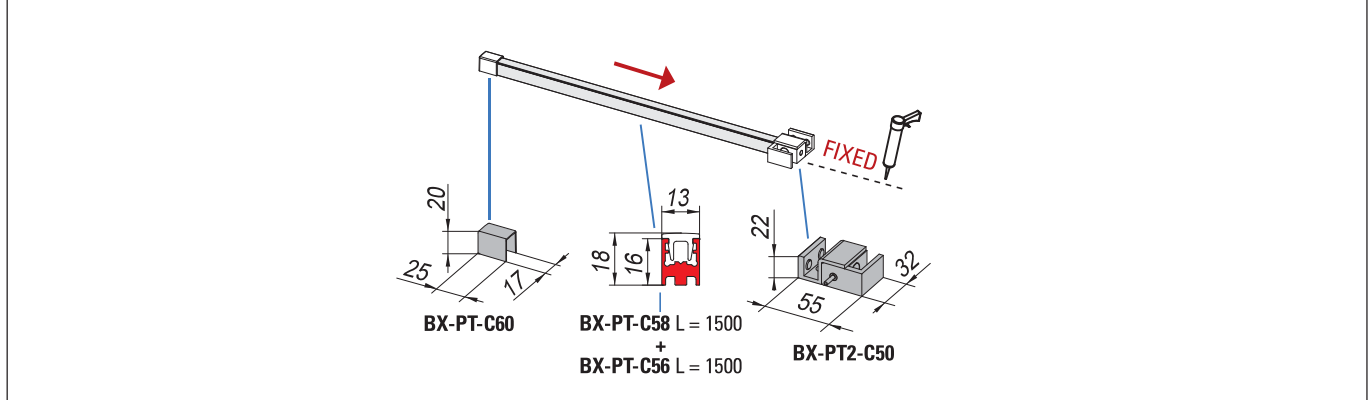
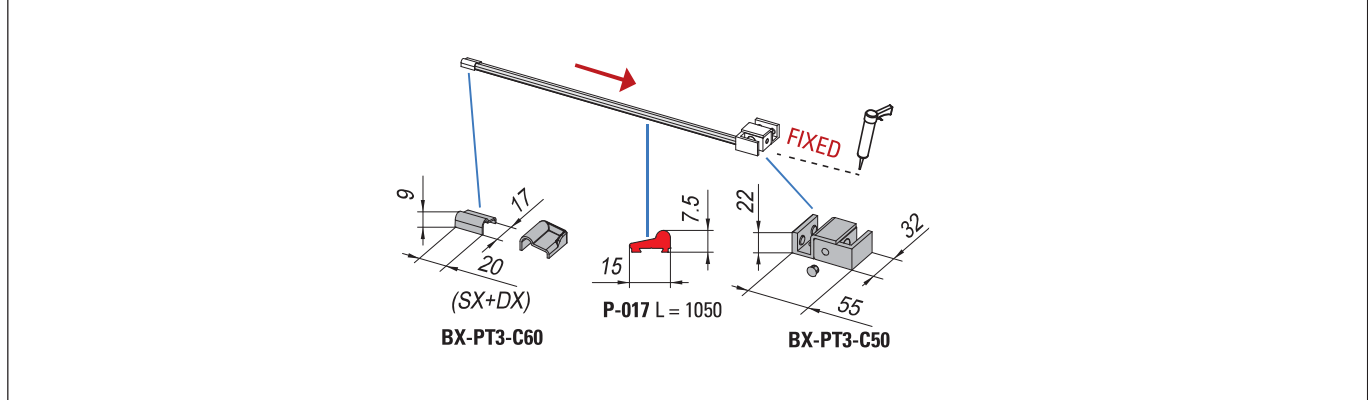
**SET 4**

SCORREVOLI

**A SET 2** L = 2200 / L = 3000 mm

**A SET 3** L = 2200 / L = 3000 mm

**A SET 4** L = 2200 / L = 3000 mm

**B SET 2**
**B SET 3**
**B SET 4**

**C SET 2**
**C SET 3**
**C SET 4**

**HM**  
 Altezza vetro mobile  
 Sliding glass height  
 Schiebeflügel Höhe

**HF**  
 Altezza vetro fisso  
 Side fixed glass height  
 Seitenteil Höhe



# BX-DIV5000

Linee che si inseguono e si incrociano separando lo spazio, ma rendendolo, allo stesso tempo qualcosa di unico...questa è la nuova doccia intelaiata DIVINA.

FUNZIONALITÀ PERFETTA E GRANDE IMPATTO ESTETICO.

- Lines that chase each other and intersect, separating the space while making it something unique...this is the new framed shower enclosure DIVINA.
- Linien, die einander folgen und sich kreuzen, die den Raum trennen, ihn aber gleichzeitig zu etwas Einzigartigem machen... das ist die neue Rahmen-Dusche DIVINA.
- FUNCTIONALITY MEETS DESIGN.
- FUNKTIONALITÄT TRIFFT AUF DESIGN.



## PLUS

- BINARIO ALTO SOLO 40 MM
- PROFILI ANTA MINIMALI
- PINZE REGOLABILI IN ALTEZZA +/- 2,5 MM
- VETRO FISSO INGLOBATO NEL BINARIO
- POSSIBILITÀ DI SOFT-CLOSE SIA IN APERTURA CHE IN CHIUSURA
- GUARNIZIONI INTEGRATE NEI PROFILI ANTA
- POSSIBILITÀ DI SGANCIARE LA GUIDA INFERIORE PER UNA PERFETTA PULIZIA
- AMPIA GAMMA DI COLORI

- Rail only 40 mm high
- Perimetral minimal size profiles
- Adjustable clamp height +/- 2,5 mm
- Fixed glass enclosed in the rail
- Possible soft-close in both opening and closure
- Panel profiles with integrated gaskets
- Quick release door function for easy cleaning
- Large choice of finishing colours

- Schienenhöhe nur 40 mm
- Rahmenprofile mit minimaler Größe
- Höhenverstellbare Laufwagen +/- 2,5 mm
- Festes Glas in die Schiene eingebaut
- Soft-close beidseitig beim öffnen und schließen möglich
- Flügelprofile mit integrierten Dichtungen
- Die auslösbare Bodenführung erleichtert das Reinigen
- Grosse Auswahl an farbigen Oberflächen

## **BX-DIV5000 (OPTIONAL SOFT-CLOSE)**



Un sistema di profili perimetrali e listelli intermedi per creare un'infinità di ante sempre diverse tra loro.

*A system of frames and intermediate profiles to create an endless number of panels, all different from each other.*

*Ein System von Rahmenprofilen und Querleisten, um eine Vielzahl von Türen zu schaffen, die sich stets voneinander unterscheiden.*



SCORREVOLI



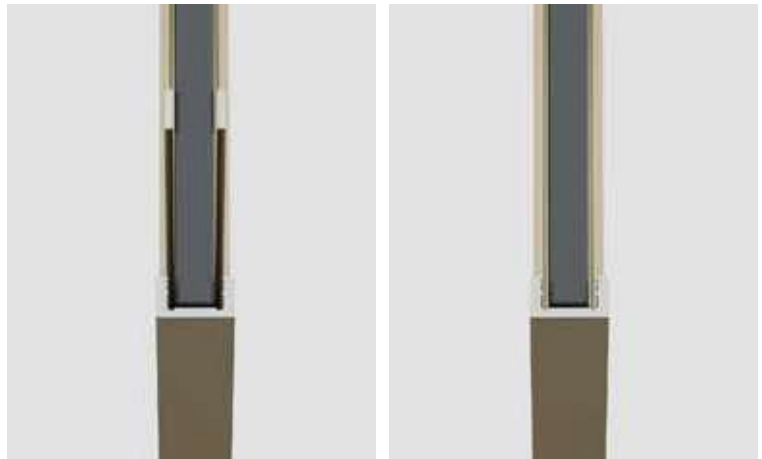

SCORREVOLI



**BX-DIV5000 SET 2**

SISTEMA  
SYSTEM  
SYSTEM

FIL-203  
TRAVERSO  
CROSS PROFILE  
QUERPROFIL

OR  
FINITURA  
FINISHING  
OBERFLÄCHE

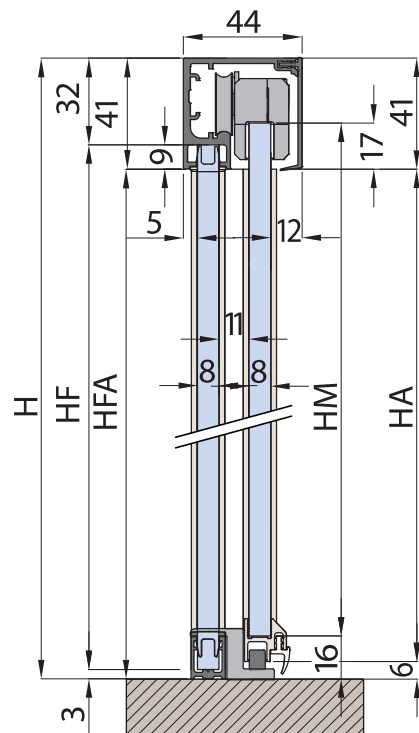

# ESCLUSIVE DEL PROGETTO

EXCLUSIVE FEATURES OF THE PROJECT - EXKLUSIV FÜR DAS PROJEKT



SCORREVOLI

- Utilizzo dell'esclusivo programma MyMetalglas per lo sviluppo delle porte. **Misure vetri, profili e lavorazioni con un solo click.**
- Use of the exclusive MyMetalglas program for door design. **Glass measurements, profiles and processes with a single click.**
- Nutzung des exklusiven Programms MyMetalglas für die Türplanung. **Glasabmessungen, Profile und Verarbeitungen mit einem Klick.**

## GAMMA FINITURE

FINISHING RANGE - OBERFLÄCHEN-SORTIMENT



CROMO  
LUCIDO

POLISHED CHROME  
CHROM GLÄNZEND

CR

NERO  
OPACO

MATT BLACK  
SCHWARZ MATT

NO

EFFETTO  
SATINATO  
INOX

INOX EFFECT  
INOX EFFEKT

IX

BIANCO  
OPACO

MATT WHITE  
WEISS MATT

BI

ORO  
OPACO

MATT GOLD  
GOLD MATT

OR





SCORREVOLI

## SET BOX DOCCIA SCORREVOLI

SHOWER BOX SET WITH SLIDING SYSTEM - SET DUSCHKABINE MIT SCHIEBETÜRSYSTEM

SCORREVOLI

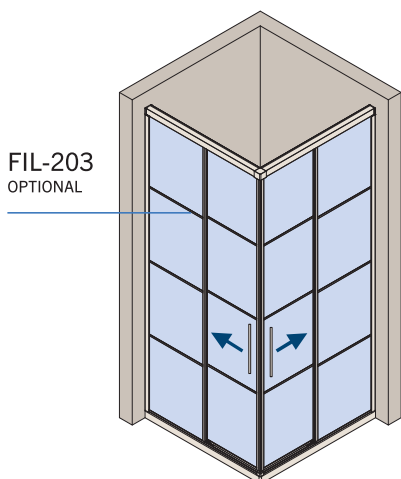

FIL-203  
OPTIONAL

**BX-DIV5000 SET 1**  
SET DOCCIA AD ANGOLO  
CON ANTE INTELAIATE, PROFILI A TERRA INCLUSI  
SET FOR CORNER SHOWER WITH FRAMED PANELS, FLOOR PROFILES INCLUDED  
SET ECKDUSCHE MIT GERAHMTEN FLÜGELN, BODENPROFILE ENTHALTEN

FIL-203 OPTIONAL  
TRAVERSO  
CROSS PROFILE  
QUERPROFIL

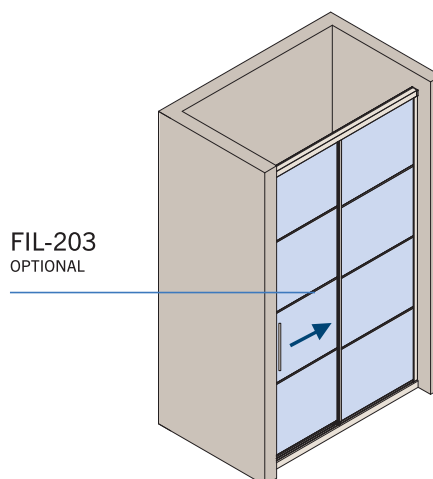

FIL-203  
OPTIONAL

**BX-DIV5000 SET 2**  
SET DOCCIA IN NICCHIA  
CON ANTE INTELAIATE, PROFILI A TERRA INCLUSI  
SET FOR NICHE SHOWER WITH FRAMED PANELS, FLOOR PROFILES INCLUDED  
SET NISCHENDUSCHE MIT GERAHMTEN FLÜGELN, BODENPROFILE ENTHALTEN

FIL-203 OPTIONAL  
TRAVERSO  
CROSS PROFILE  
QUERPROFIL

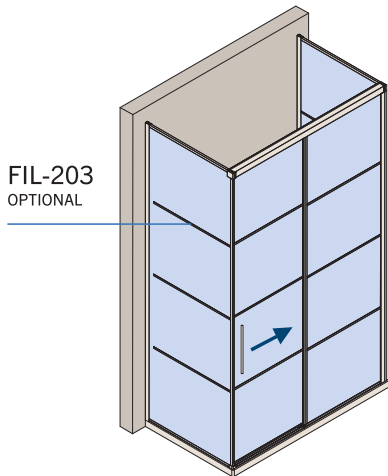

FIL-203  
OPTIONAL

**BX-DIV5000 SET 3**  
SET DOCCIA A "U"  
CON ANTE INTELAIATE, PROFILI A TERRA INCLUSI  
SET FOR "U" SHOWER WITH FRAMED PANELS, FLOOR PROFILES INCLUDED  
SET "U" DUSCHE MIT GERAHMTEN FLÜGELN, BODENPROFILE ENTHALTEN

FIL-203 OPTIONAL  
TRAVERSO  
CROSS PROFILE  
QUERPROFIL

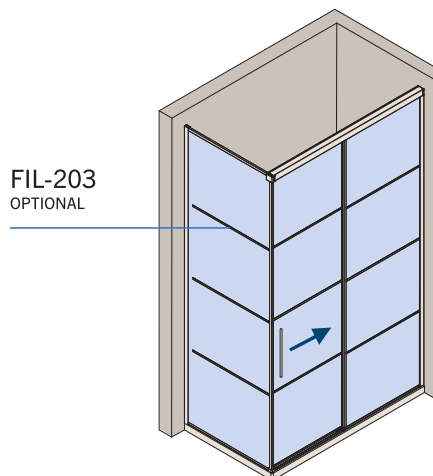

FIL-203  
OPTIONAL

**BX-DIV5000 SET 4**  
SET DOCCIA AD ANGOLO  
CON 1 ANTA SCORREVOLE INTELAIATA, PROFILI A TERRA INCLUSI  
SET FOR CORNER SHOWER WITH FRAMED PANELS FRONTAL ENTRY, FLOOR PROFILES INCLUDED  
SET ECKDUSCHE FRONTEINSTIEG, MIT GERAHMTEN FLÜGELN BODENPROFILE ENTHALTEN

FIL-203 OPTIONAL  
TRAVERSO  
CROSS PROFILE  
QUERPROFIL



# PROFILI (GUARNIZIONI INCLUSE)

PROFILES (GASKETS INCLUDED) - PROFILE (DICHTUNGEN ENTHALTEN)

BX-DIV502

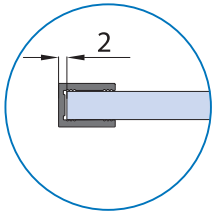
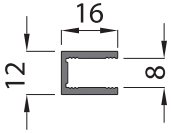

BX-DIV526

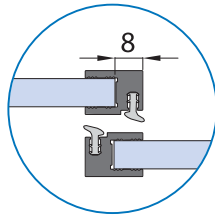
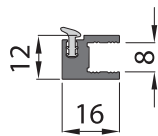

BX-DIV527

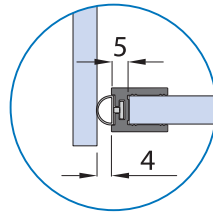
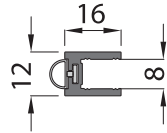

BX-DIV543

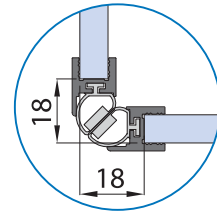
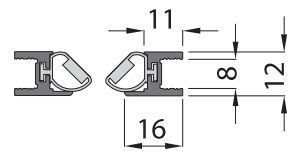

BX-DIV519

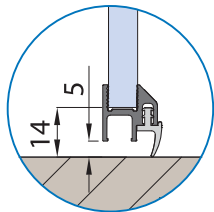
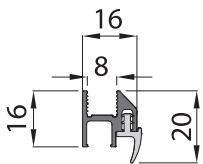

BX-PT-C58

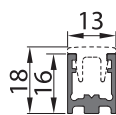

FIL-203

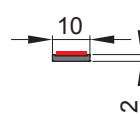

 Biadesivo preinstallato  
 Pre-installed  
 double-sided adhesive  
 Selbstklebend

SCORREVOLI

# COMPOSIZIONE ANTE E PROFILI A TERRA

PANELS' LAYOUT AND FLOOR PROFILES - FLÜGEL LAYOUT UND BODENPROFILE

## MY METALGLAS

Componi la tua ante per quantificare i traversini da ordinare  
Configure your panel to calculate the cross profiles  
Konfigurieren Sie Ihre Tür und berechnen Sie automatisch die Querprofile

### SET 1

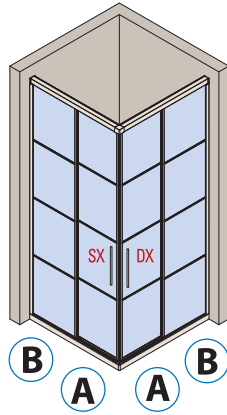

BX-PT-01 set 1

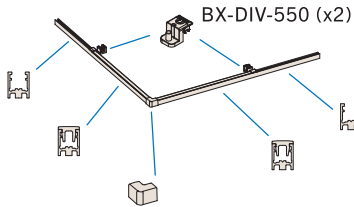

### SET 2

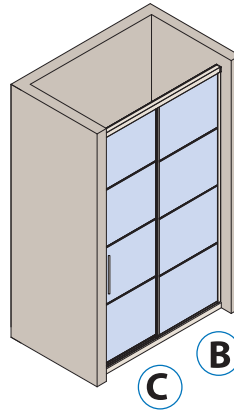

BX-PT-01 set 2

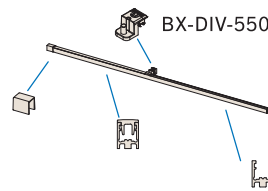

### SET 3

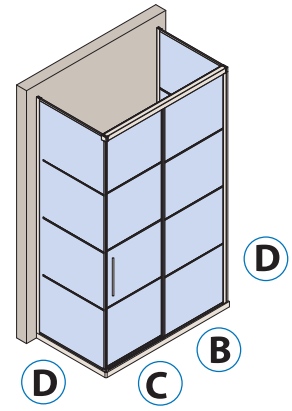

BX-PT-01 set 3

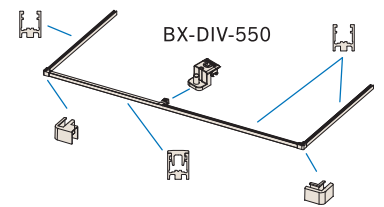

### SET 4

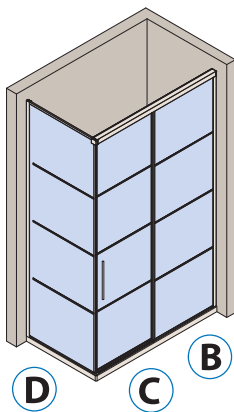

BX-PT-01 set 4

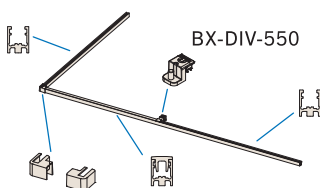

### SET 5

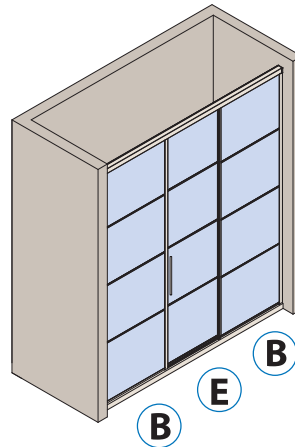

BX-PT-01 set 5

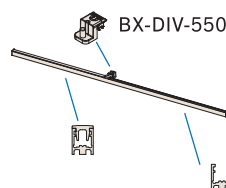

### SET 6

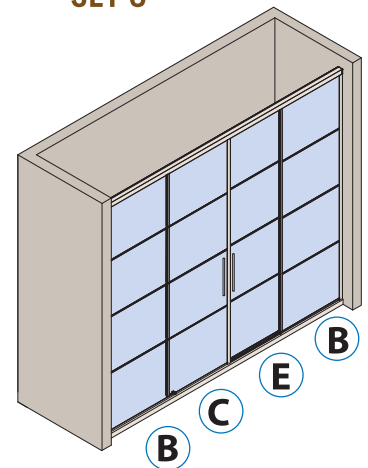

BX-PT-01 set 6

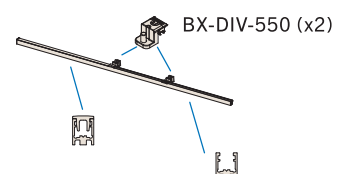

SCORREVOLI

**BX-DIV-ANT-A-DX**  
**BX-DIV-ANT-A-SX**  
ANTA SCORREVOLE A  
SLIDING PANEL A  
SCHIEBETÜR A

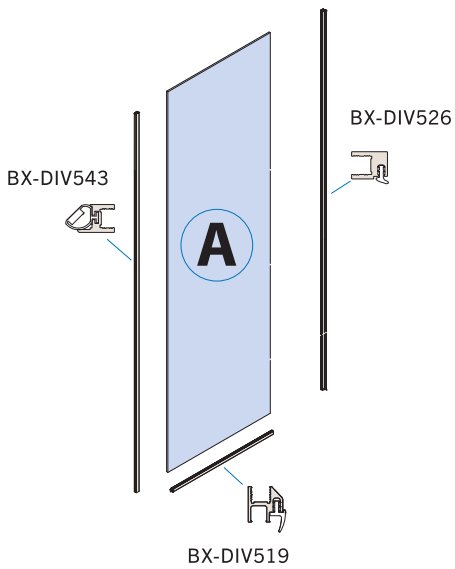

**BX-DIV-ANT-B**  
ANTA FISSA B  
FIXED PANEL B  
SEITENTEIL B

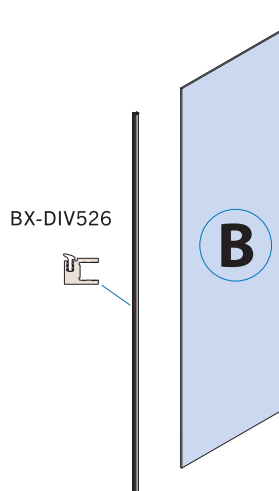

**BX-DIV-ANT-C**  
ANTA SCORREVOLE C  
SLIDING PANEL C  
SCHIEBETÜR C

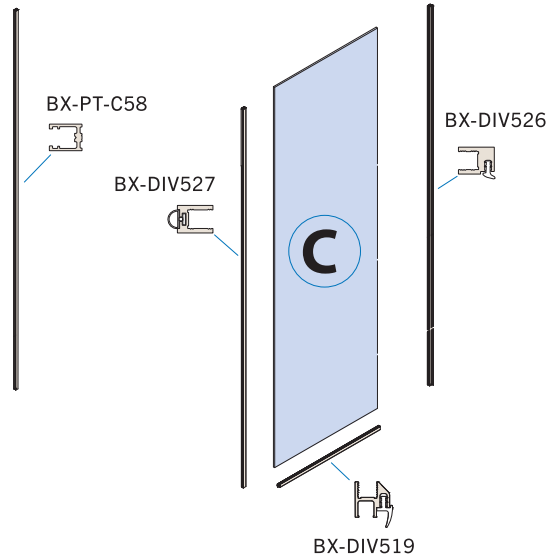

SCORREVOLI

**BX-DIV-ANT-D**  
ANTA FISSA LATERALE D  
FLATERAL FIXED PANEL D  
SEITENTEIL D

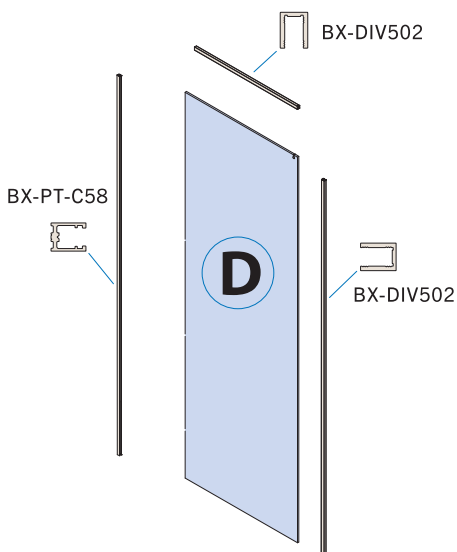

**BX-DIV-ANT-E**  
ANTA SCORREVOLE E  
SLIDING PANEL E  
SCHIEBETÜR E

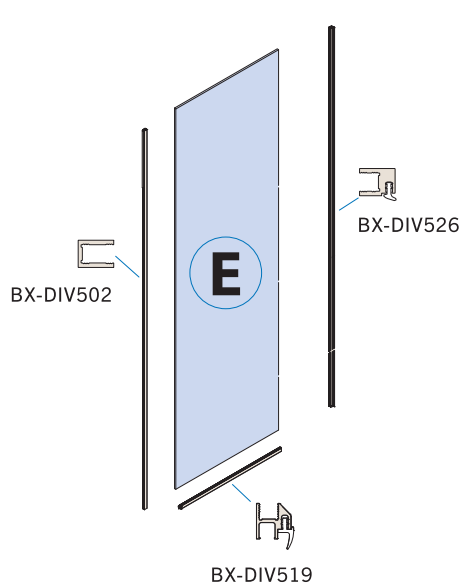

**FIL-203 OPTIONAL**  
TRAVERSO  
CROSS PROFILE  
QUERPROFIL

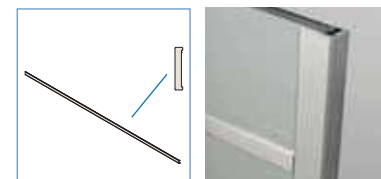

# MANIGLIE

HANDLES - GRIFFE

**DIV-007**  
CR - NO - NS - BI - BC



**DIV-008**  
CR - NO - NS - BI - BC



**V-526**  
CR - NO - NS - OR

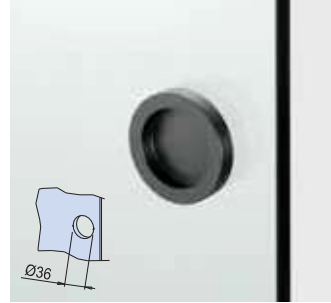

**POR-0408**  
CR - AL - NO - XO - BI - OR



**B-196**  
CR - NO - NS - OR

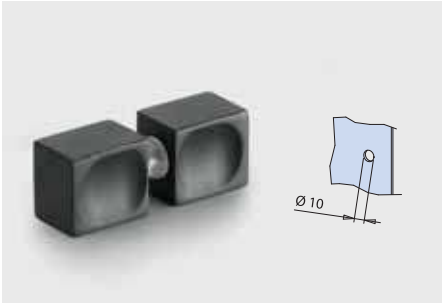

# FINITURE

FINISHES - OBERFLÄCHEN

CR / AL



NO



IX / NS / XO



BI



OR



SCORREVOLI



# BX-DIV5000 SET 1 L = 1000 X 1000 MM

DOCCIA IN ANGOLO - CORNER SHOWER - ECKDUSCHE

FINITURE - FINISHING - OBERFLÄCHEN: CR - NO - IX - BI - OR ▶ 22

MY METALGLAS

## COMPONENTI - COMPONENTS - EINZELTEILE

**BX-5000-C10** (2x)

**BX-5000-C30** (4x)

**BX-5000-C90 SX** (1x)  
**BX-5000-C90 DX** (1x)

**BX-5000-C20** (1x)

**BX-DIV-550** (2x)

**BX-5006** (2x)   
**OPTIONAL SOFT-CLOSE**

**OPTIONAL** (2x)

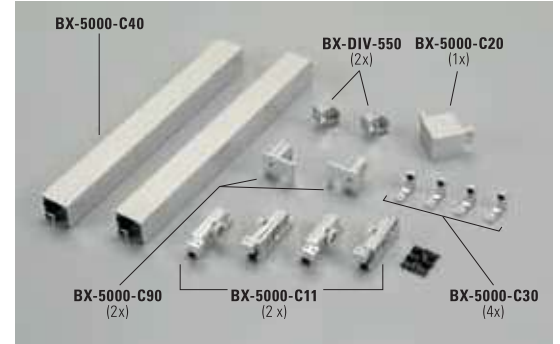
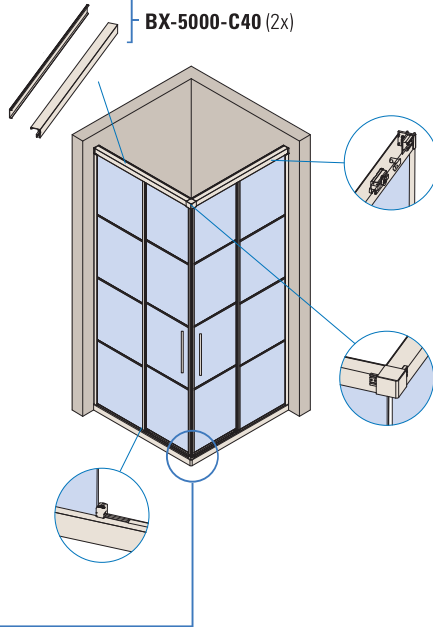

**CARATTERISTICHE COMPONENTI**  
FEATURES COMPONENTS - EIGENSCHAFTEN EINZELTEILE  
▶ 42

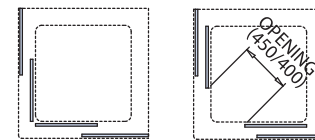
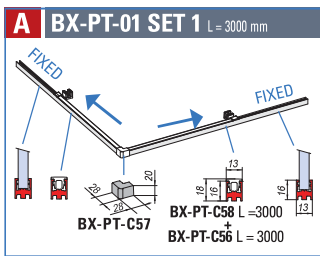

**PROFILI A TERRA**  
FLOOR PROFILES - BODENPROFILE  
▶ 106

xme632e

## LAVORAZIONE PROFILI ANTA - PANEL PROFILES PREPARATION - FLÜGELPROFILE BEARBEITUNG

### BX-DIV-ANT-A-DX BX-DIV-ANT-A-SX

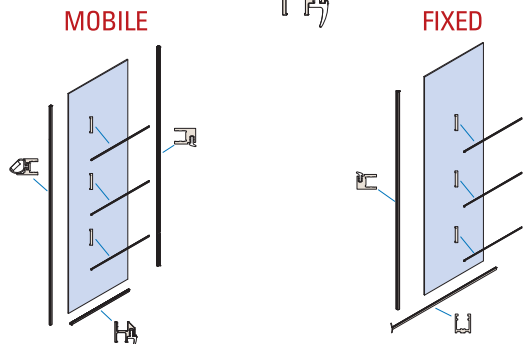
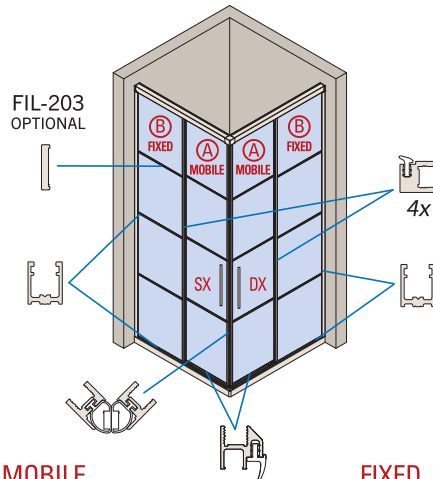
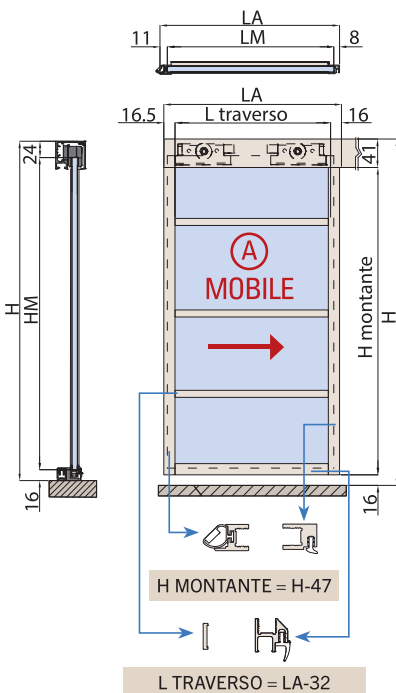

### BX-DIV-ANT-B

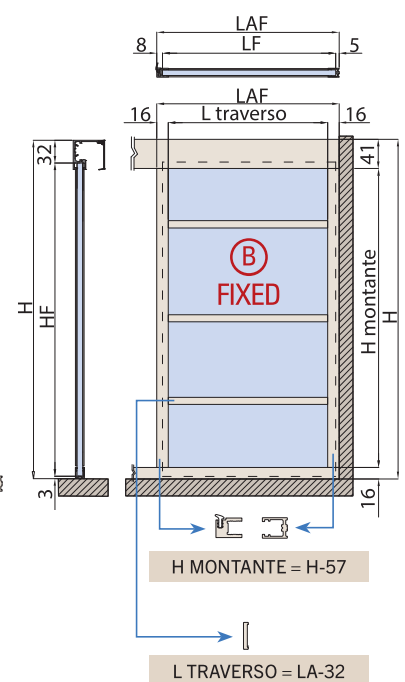

xme632a/xme632d

<b>L</b> Piatto Shower tray Duschtaße	<b>LM</b> Larghezza vetro mobile Sliding glass width Glasbreite-Schiebeflügel	<b>LF</b> Larghezza vetro fisso Side fixed glass width Festglasbreite	<b>HM</b> Altezza vetro mobile Sliding glass height Schiebeflügel Höhe	<b>HF</b> Altezza vetro fisso Side fixed glass height Glashöhe Festverglasung
--	--	--	---	--

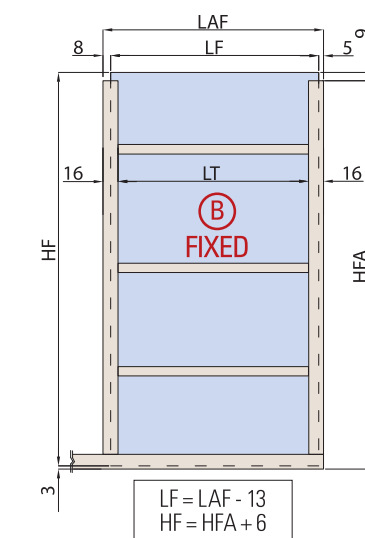
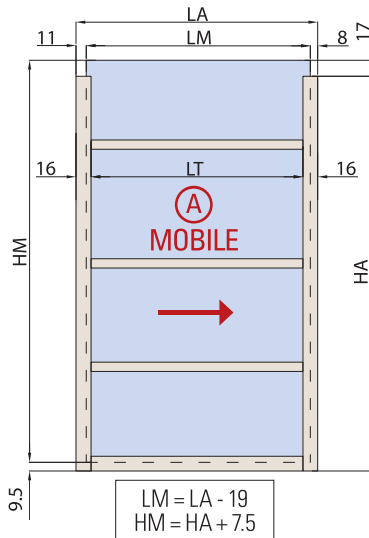
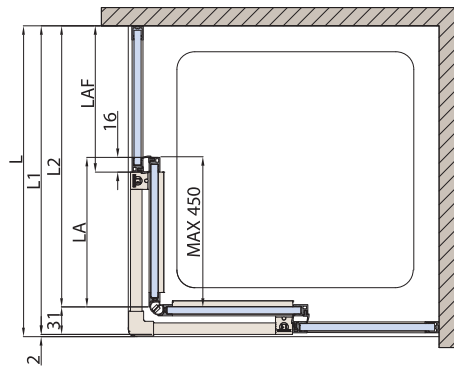
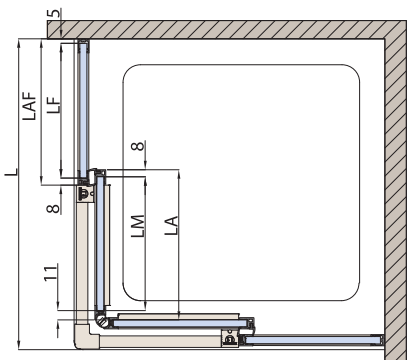
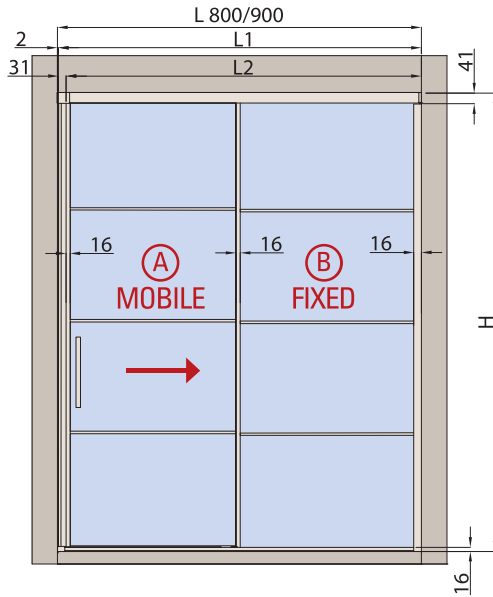
**LAVORAZIONE VETRO - GLASS PREPARATION - GLASBEARBEITUNG**

**CALCOLO VETRO - CALCULATION GLASS - GLASBERECHNUNG**

PIATTO - SHOWER TRAY - DUSCHTASSE (L) = 800 - 900 mm

 $L1 = L - 2$                        $HA = H - 47$   
 $L2 = L1 - 31$                      $HFA = H - 41$   
 $LA = LAF = (L2 + 16) / 2$ 
**PROFILI A TERRA - FLOOR PROFILES - BODENPROFILE ▶ 106**
**A BX-PT-01** STANDARD HF = H - 35

**H** Altezza doccia  
 Shower height  
 Duschkabine Höhe  
**LA** Larghezza anta mobile  
 Sliding door width  
 Schiebeflügel Breite

**HA** Altezza profilo verticale anta scorrevole  
 Vertical profile height sliding panel  
 Vertikalprofil Höhe Schiebeflügel

**LAF** Larghezza anta fissa  
 Fixed panel width  
 Seitenteil Breite

**HFA** Altezza profilo verticale anta fissa  
 Vertical profile height fixed panel  
 Vertikalprofil Höhe Seitenteil

**SET 1**

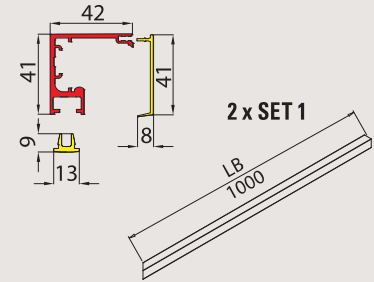
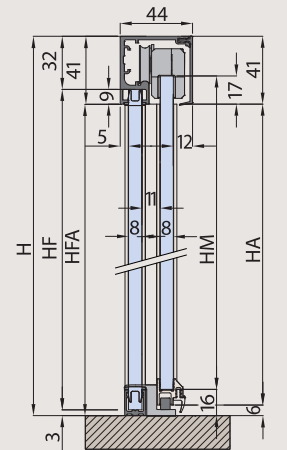
 DA TAGLIARE ✂  
 ADJUST THE LENGTH  
 BELIEBIG KÜRZBAR

 REGOLAZIONE RUOTA ± 2 MM.  
 ADJUSTMENT ± 2 MM.  
 VERSTELLUNG ± 2 MM.

 $HM = H - 40$        $HA = H - 47$   
 $HF = H - 35$        $HFA = H - 41$ 
**OPTIONAL**

xme632m

SCORREVOLI

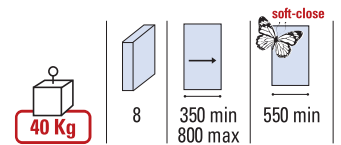
# BX-DIV5000 SET 2 L = 1500 MM / L = 3000 MM

## DOCCIA IN NICCHIA - NICHE SHOWER - NISCHENDUSCHE



FINITURE - FINISHING - OBERFLÄCHEN: CR - NO - IX - BI - OR ▶ 22

MY METALGLAS

### COMPONENTI - COMPONENTS - EINZELTEILE

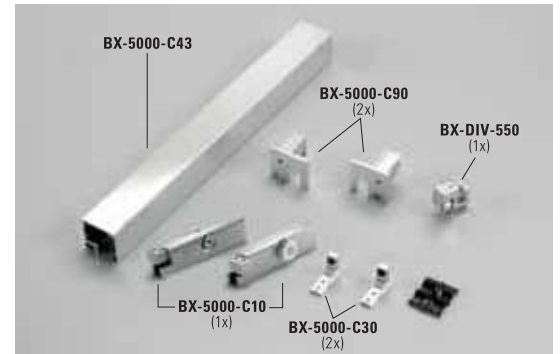
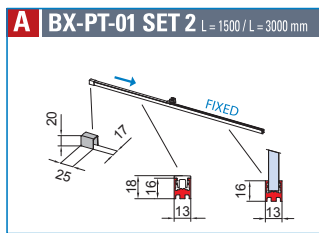
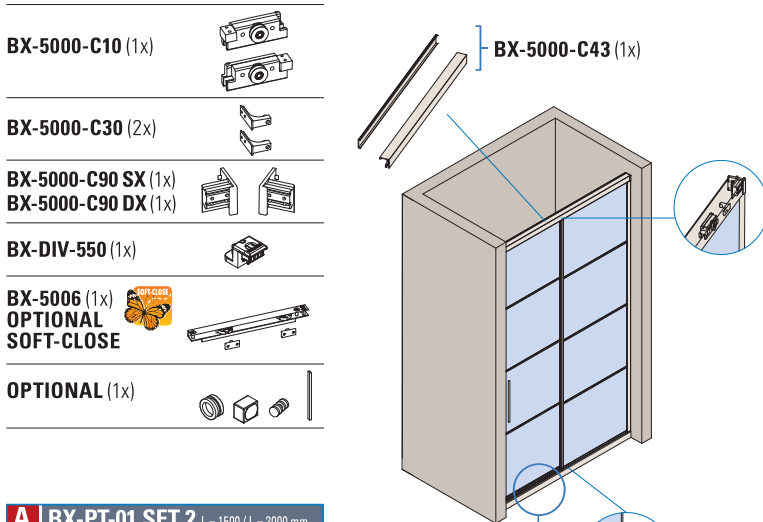

CARATTERISTICHE COMPONENTI  
FEATURES COMPONENTS - EIGENSCHAFTEN EINZELTEILE  
▶ 42

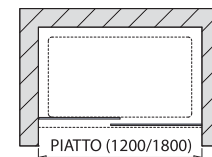

PROFILI A TERRA  
FLOOR PROFILES - BODENPROFILE  
▶ 106

xme632e

### LAVORAZIONE PROFILI ANTA - PANEL PROFILES PREPARATION - FLÜGELPROFILE BEARBEITUNG

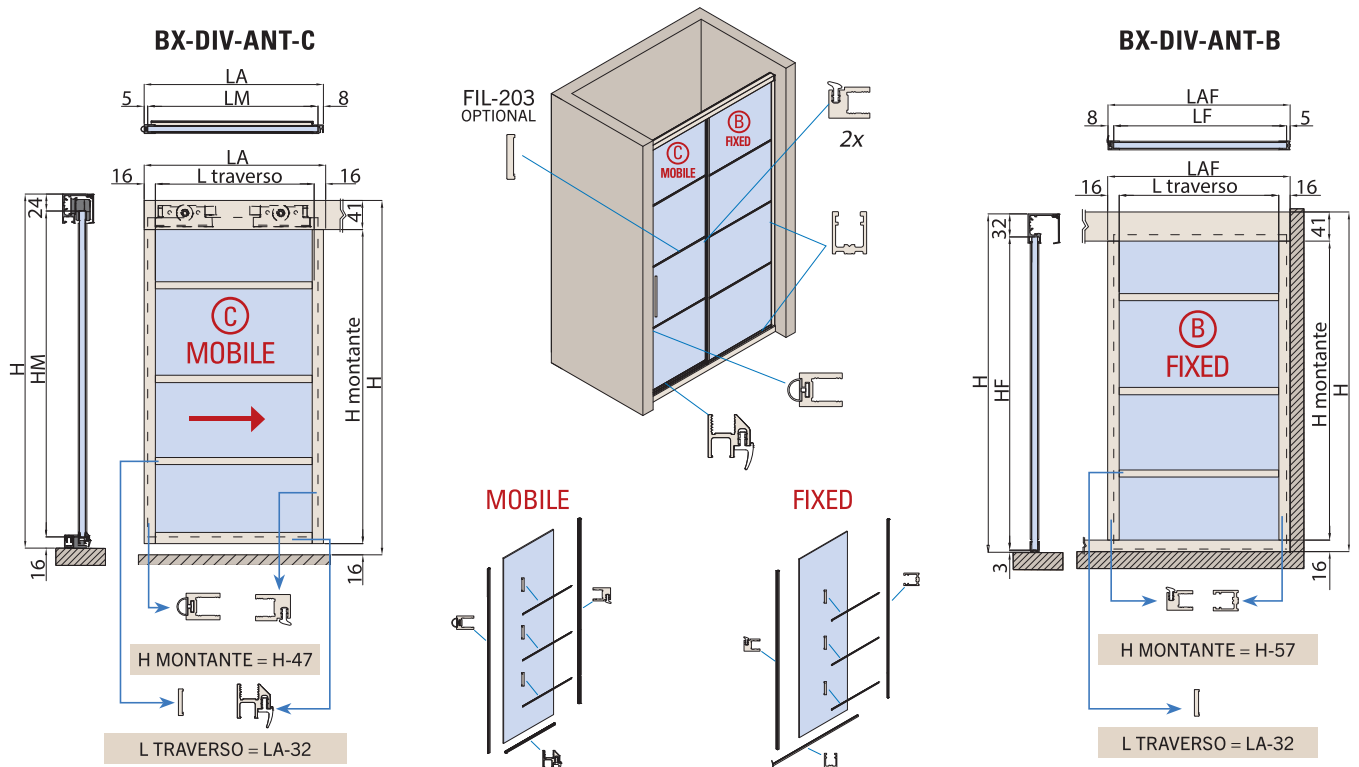

xme632a/xme632b

<b>L</b> Piatto Shower tray Duschtaße	<b>LM</b> Larghezza vetro mobile Sliding glass width Glasbreite-Schiebefügel	<b>LF</b> Larghezza vetro fisso Side fixed glass width Festglasbreite	<b>HM</b> Altezza vetro mobile Sliding glass height Schiebefügel Höhe	<b>HF</b> Altezza vetro fisso Side fixed glass height Glashöhe Festverglasung
--	---	--	--	--

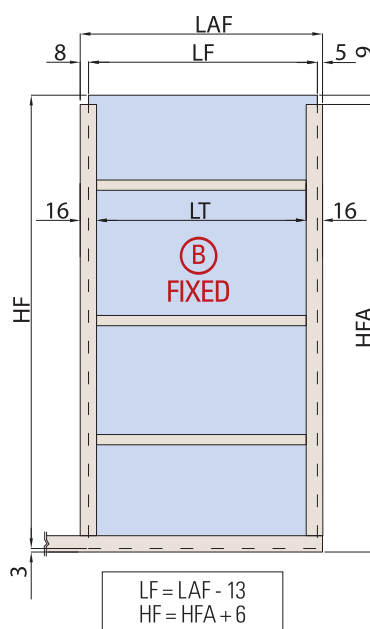
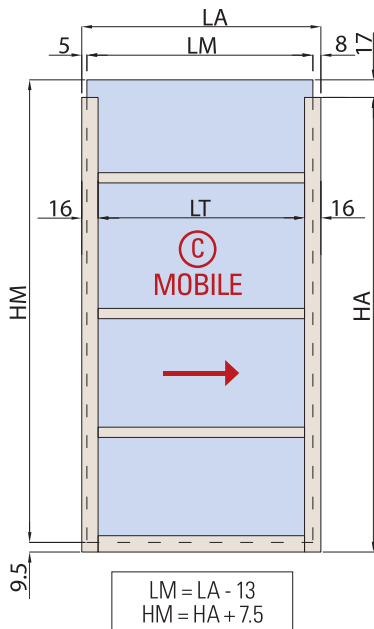
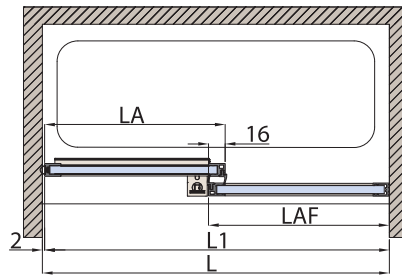
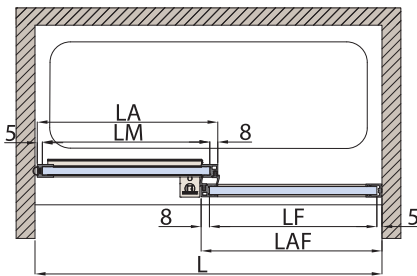
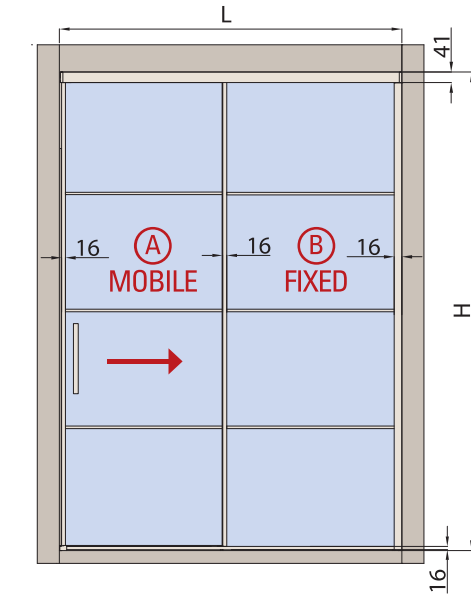
**LAVORAZIONE VETRO - GLASS PREPARATION - GLASBEARBEITUNG**

**CALCOLO VETRO - CALCULATION GLASS - GLASBERECHNUNG**

L = PIATTO - SHOWER TRAY - DUSCHTASSE (L)

 $L1 = L - 2$ 
 $LA = LAF = (L1 + 16) / 2$ 
 $HA = H - 47$ 
 $HFA = H - 41$ 
**PROFILI A TERRA - FLOOR PROFILES - BODENPROFILE ▶ 106**
**A BX-PT-01** STANDARD  $HF = H - 35 = 1965$  mm

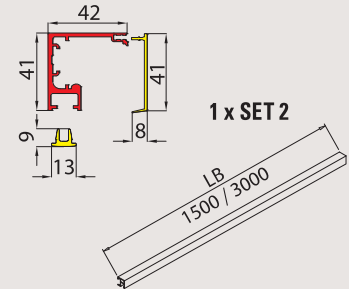
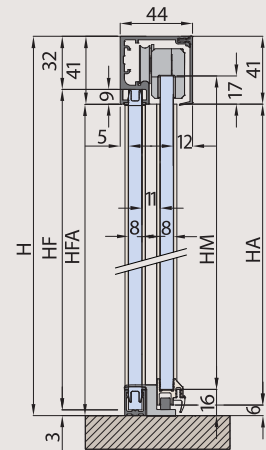
**SET 2**

 DA TAGLIARE ✂  
 ADJUST THE LENGTH  
 BELIEBIG KÜRZBAR

 REGOLAZIONE RUOTA ± 2 MM.  
 ADJUSTMENT ± 2 MM.  
 VERSTELLUNG ± 2 MM.

$HM = H - 40$	$HA = H - 47$
$HF = H - 35$	$HFA = H - 41$

$HF = H - 35$ solo per / only for <b>A BX-PT-01</b>
--

**OPTIONAL**

xme632i

**H**  
 Altezza doccia  
 Shower height  
 Duschkabine Höhe

**LA**  
 Larghezza anta mobile  
 Sliding door width  
 Schiebeflügel Breite

**HA**  
 Altezza profilo verticale anta scorrevole  
 Vertical profile height sliding panel  
 Vertikalprofil Höhe Schiebeflügel

**LAF**  
 Larghezza anta fissa  
 Fixed panel width  
 Seitenteil Breite

**HFA**  
 Altezza profilo verticale anta fissa  
 Vertical profile height fixed panel  
 Vertikalprofil Höhe Seitenteil

# BX-DIV5000 SET 3 L = 1500 MM / L = 3000 MM

DOCCIA A U - U SHOWER - U DUSCHE

FINITURE - FINISHING - OBERFLÄCHEN: CR - NO - IX - BI - OR ▶ 22

MY METALGLAS

## COMPONENTI - COMPONENTS - EINZELTEILE

- BX-5000-C10** (1x)
- BX-5000-C30** (2x)
- BX-5000-C90 SX** (1x)  
**BX-5000-C90 DX** (1x)
- BX-5000-C81 SX** (1x)  
**BX-5000-C81 DX** (1x)
- BX-DIV-550** (1x)
- BX-5006** (1x) **OPTIONAL SOFT-CLOSE**
- OPTIONAL** (1x)

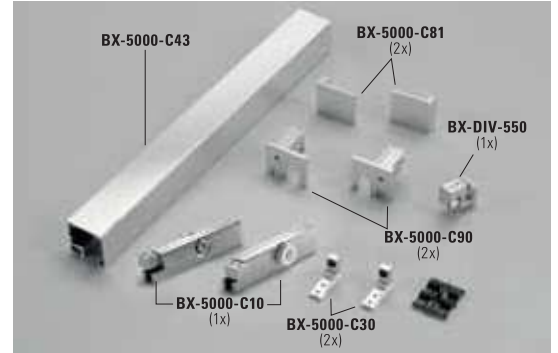
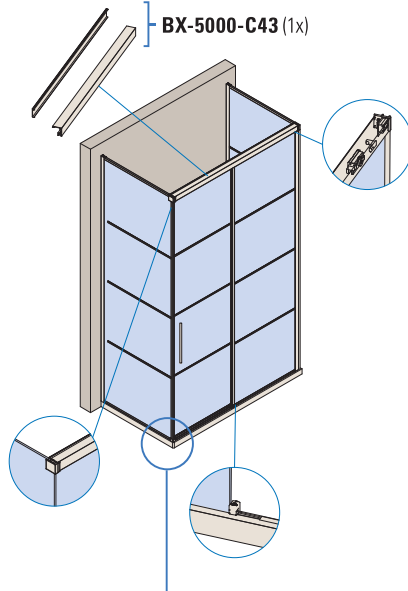

**CARATTERISTICHE COMPONENTI**  
FEATURES COMPONENTS - EIGENSCHAFTEN EINZELTEILE  
▶ 42

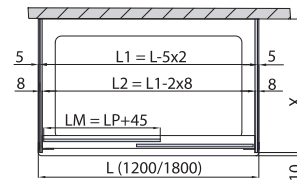
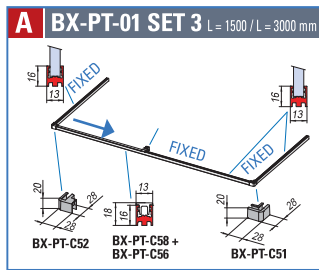

**PROFILI A TERRA**  
FLOOR PROFILES - BODENPROFILE ▶ 106 xme632f

## LAVORAZIONE PROFILI ANTA - PANEL PROFILES PREPARATION - FLÜGELPROFILE BEARBEITUNG

### BX-DIV-ANT-C

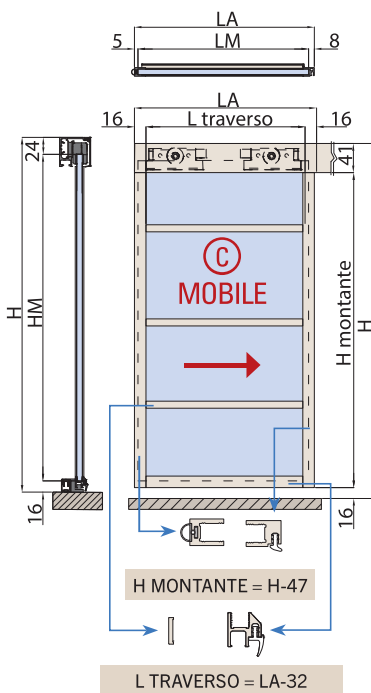

### BX-DIV-ANT-B

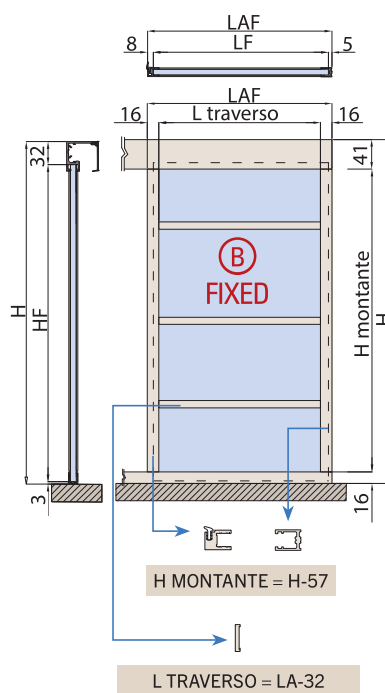

### BX-DIV-ANT-D

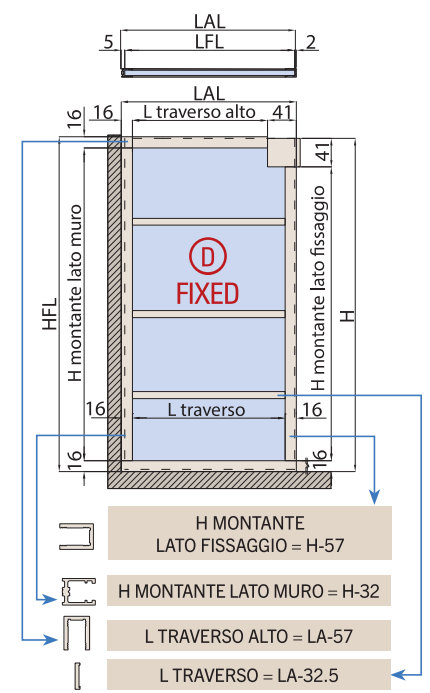

xme632a/xme632b/xme632c

<b>L</b> Piatto Shower tray Duschtaße	<b>LM</b> Larghezza vetro mobile Sliding glass width Glasbreite-Schiebeflügel	<b>LF / LFL</b> Larghezza vetro fisso Side fixed glass width Festglasbreite	<b>HM</b> Altezza vetro mobile Sliding glass height Schiebeflügel Höhe	<b>HF / HFL</b> Altezza vetro fisso Side fixed glass height Glashöhe Festverglasung
--	--	--	---	--

SCORREVOLI



# BX-DIV5000 SET 4 L = 1500 MM / L = 3000 MM

DOCCIA CON SPALLA IN VETRO - CORNER SHOWER WITH 2 FIXED PANEL  
ECKDUSCHE MIT 2 FESTSTEHENDEN GLASTAFELN

FINITURE - FINISHING - OBERFLÄCHEN: CR - NO - IX - BI - OR ▶ 22

**MY METALGLAS**

## COMPONENTI - COMPONENTS - EINZELTEILE

- BX-5000-C10** (1x)
- BX-5000-C30** (2x)
- BX-5000-C90 SX** (1x)  
**BX-5000-C90 DX** (1x)
- BX-5000-C81 SX/DX** (1x)
- BX-DIV-550** (1x)
- BX-5006** (1x) **OPTIONAL SOFT-CLOSE**
- OPTIONAL** (1x)

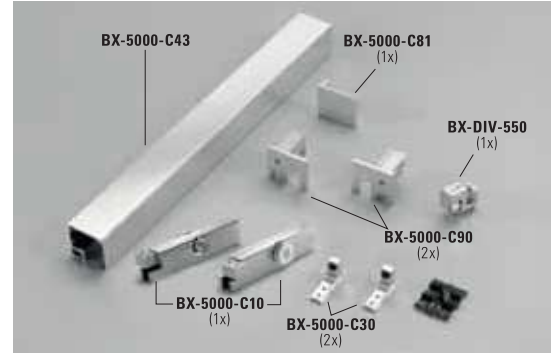
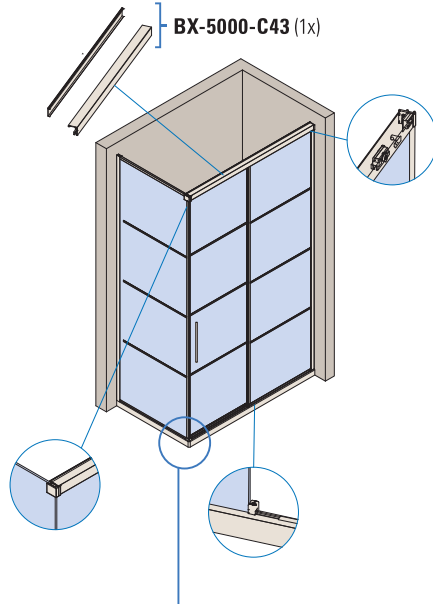

**CARATTERISTICHE COMPONENTI**  
FEATURES COMPONENTS - EIGENSCHAFTEN EINZELTEILE  
▶ 42

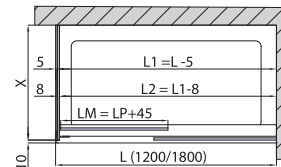
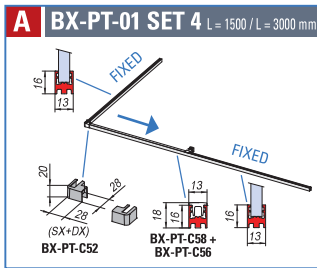

**PROFILI A TERRA**  
FLOOR PROFILES - BODENPROFILE  
▶ 106

xme632f

## LAVORAZIONE PROFILI ANTA - PANEL PROFILES PREPARATION - FLÜGELPROFILE BEARBEITUNG

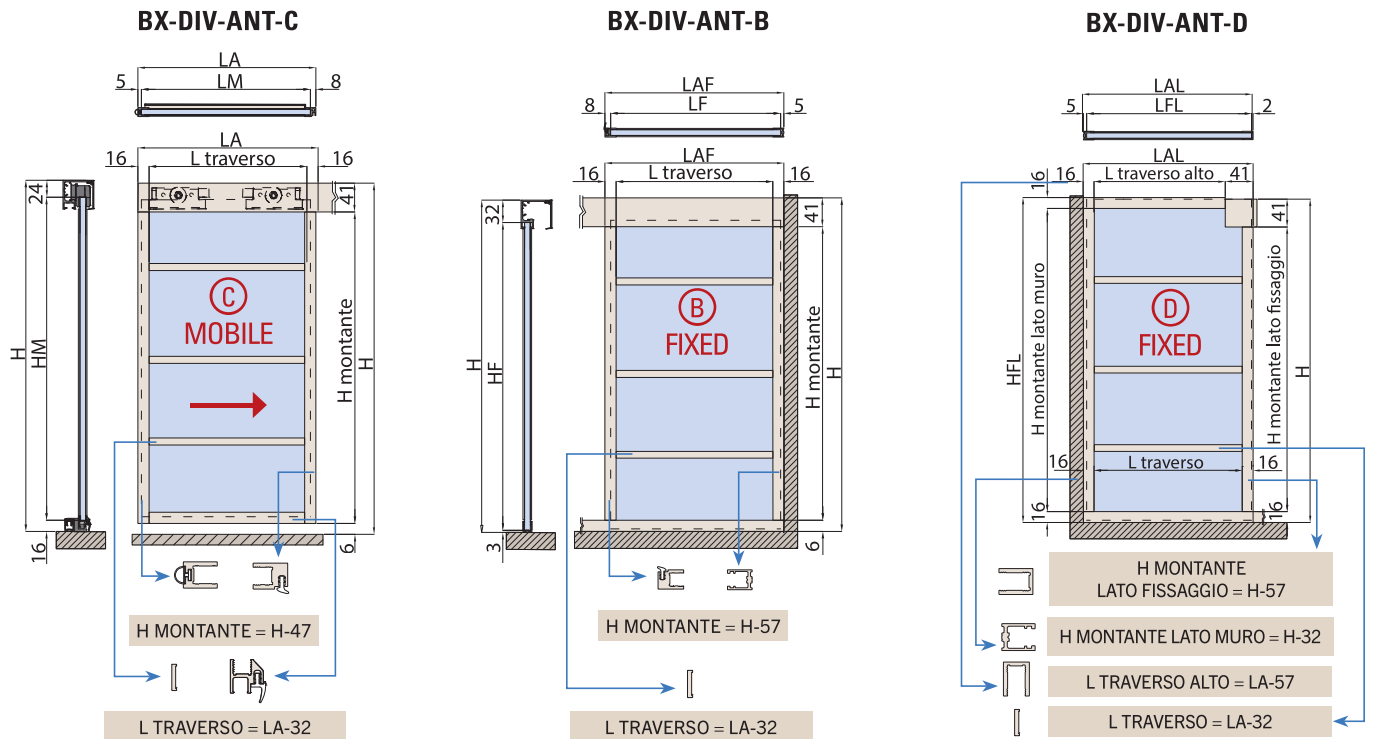

xme632a/xme632b/xme632c

<b>L</b> Piatto Shower tray Duschtaße	<b>LM</b> Larghezza vetro mobile Sliding glass width Glasbreite-Schiebeflügel	<b>LF</b> Larghezza vetro fisso Side fixed glass width Festglasbreite	<b>HM</b> Altezza vetro mobile Sliding glass height Schiebeflügel Höhe	<b>HF</b> Altezza vetro fisso Side fixed glass height Glashöhe Festverglasung
--	--	--	---	--

SCORREVOLI

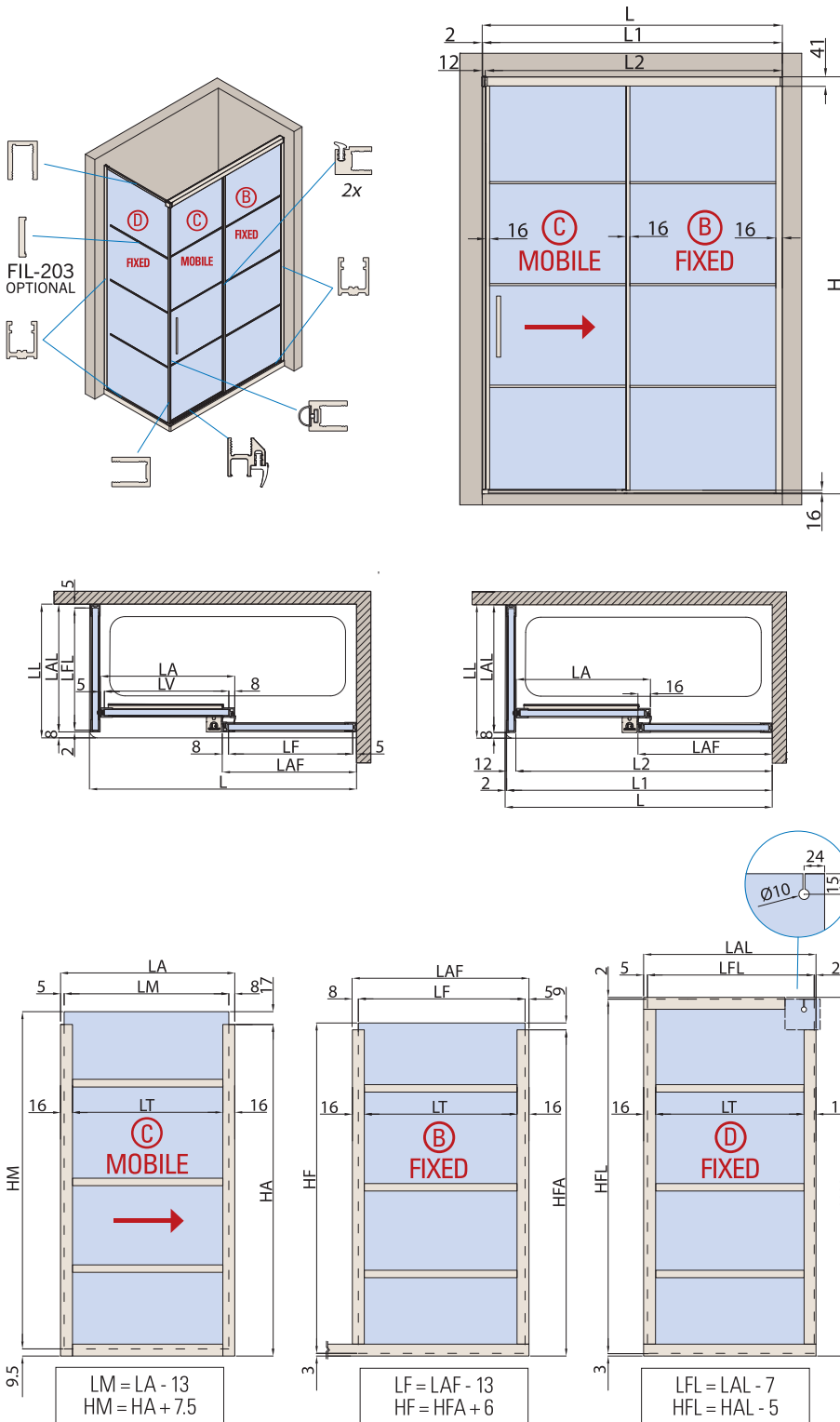
**LAVORAZIONE VETRO - GLASS PREPARATION - GLASBEARBEITUNG**

**CALCOLO VETRO - CALCULATION GLASS - GLASBERECHNUNG**

L = PIATTO - SHOWER TRAY - DUSCHTASSE  
 L1 = L - 2                      HA = H - 47  
 L2 = L1 - 12                  HFA = H - 41  
 LA = LAF = (L2 + 16) / 2      HAL = H  
 LAL = LL - 8

**PROFILI A TERRA - FLOOR PROFILES - BODENPROFILE ▶ 106**

**A BX-PT-01** STANDARD HF = H - 35 = 1965 mm

xme632h

**H**  
 Altezza doccia  
 Shower height  
 Duschkabine Höhe

**LA**  
 Larghezza anta mobile  
 Sliding door width  
 Schiebeflügel Breite

**HA**  
 Altezza profilo verticale anta scorrevole  
 Vertical profile height sliding panel  
 Vertikalprofil Höhe Schiebeflügel

**LAF**  
 Larghezza anta fissa  
 Fixed panel width  
 Seitenteil Breite

**HFA**  
 Altezza profilo verticale anta fissa  
 Vertical profile height fixed panel  
 Vertikalprofil Höhe Seitenteil

**SET 4**

DA TAGLIARE ✂  
 ADJUST THE LENGTH  
 BELIEBIG KÜRZBAR

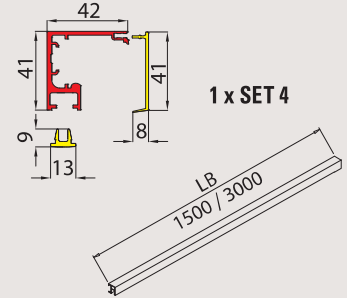

REGOLAZIONE RUOTA  $\pm 2$  MM.  
 ADJUSTMENT  $\pm 2$  MM.  
 VERSTELLUNG  $\pm 2$  MM.

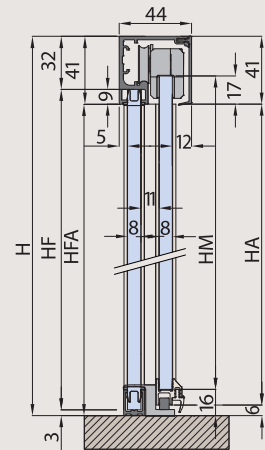

HM = H - 40      HA = H - 47  
 HF = H - 35      HFA = H - 41

**OPTIONAL**

SCORREVOLI

# BX-DIV5000 SET 5 L = 3000 MM

DOCCIA CON 2 VETRI FISSI E UNO MOBILE - SHOWER WITH 2 FIXED PANELS AND 1 SLIDING PANEL - DUSCHKABIN MIT 2 SEITENTEILEN UND 1 SCHIEBETÜR

FINITURE - FINISHING - OBERFLÄCHEN: CR - NO - IX - BI - OR ▶ 22

**40 Kg**

8

350 min  
800 max

soft-close  
550 min

**MY METALGLAS**

## COMPONENTI - COMPONENTS - EINZELTEILE

**BX-5000-C10** (1x)

**BX-5000-C30** (2x)

**BX-5000-C90 SX** (1x)  
**BX-5000-C90 DX** (1x)

**BX-DIV-550** (1x)

**BX-5006** (1x)  
**OPTIONAL SOFT-CLOSE**

**OPTIONAL** (1x)

**BX-5000-C43** (1x)

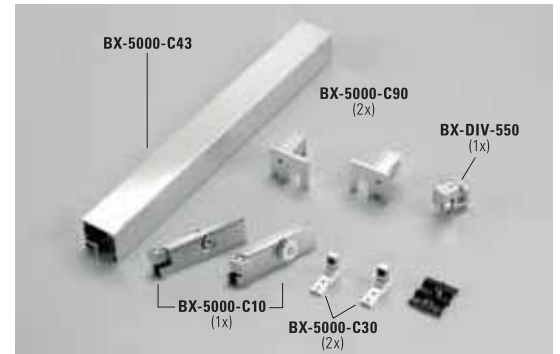

**CARATTERISTICHE COMPONENTI**  
FEATURES COMPONENTS - EIGENSCHAFTEN EINZELTEILE  
▶ 42

**A BX-PT-01 SET 2** L = 3000 mm

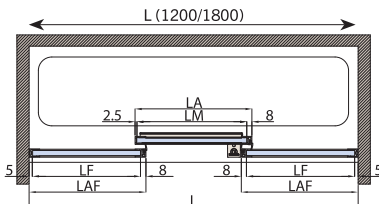

**PROFILI A TERRA**  
FLOOR PROFILES - BODENPROFILE  
▶ 106

xme632r

## LAVORAZIONE PROFILI ANTA - PANEL PROFILES PREPARATION - FLÜGELPROFILE BEARBEITUNG

**BX-DIV-ANT-E**

FIL-203  
OPTIONAL

**BX-DIV-ANT-B**

xme632a/xme632r

<b>L</b> Piatto Shower tray Duschtaße	<b>LM</b> Larghezza vetro mobile Sliding glass width Glasbreite-Schiebefügel	<b>LF</b> Larghezza vetro fisso Side fixed glass width Festglasbreite	<b>HM</b> Altezza vetro mobile Sliding glass height Schiebefügel Höhe	<b>HF</b> Altezza vetro fisso Side fixed glass height Glashöhe Festverglasung
--	---	--	--	--

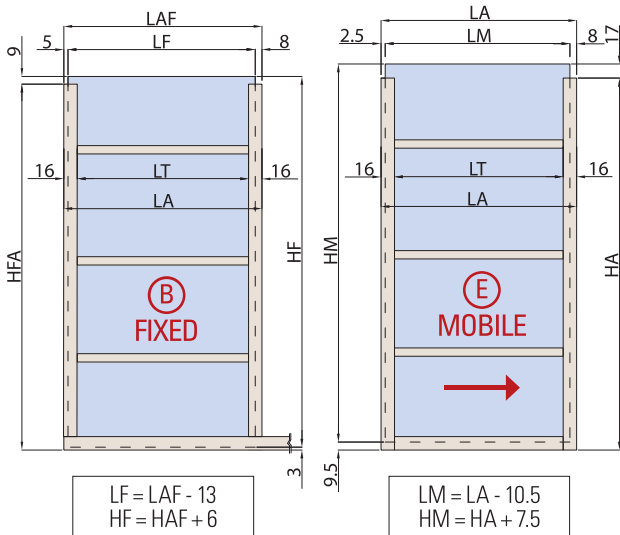
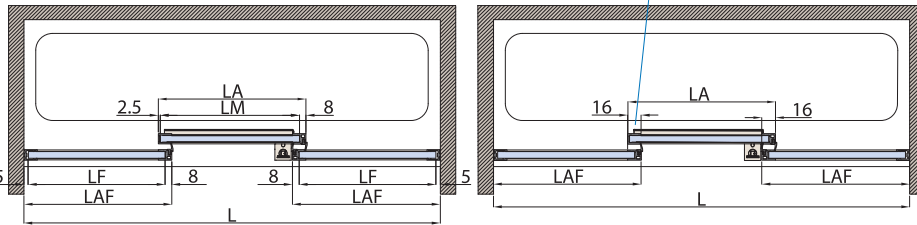
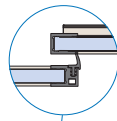
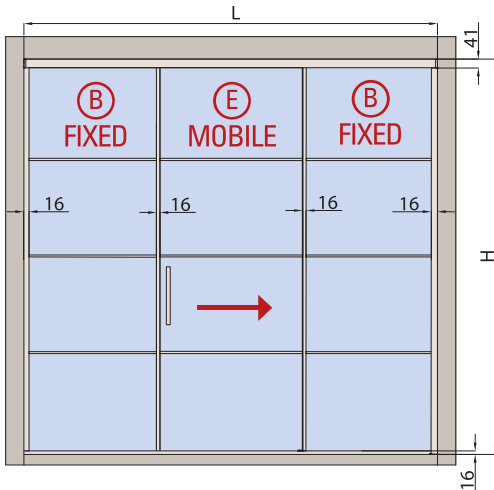
**LAVORAZIONE VETRO - GLASS PREPARATION - GLASBEARBEITUNG**

**CALCOLO VETRO - CALCULATION GLASS - GLASBERECHNUNG**

L = PIATTO - SHOWER TRAY - DUSCHTASSE

 $LA = LAF = (L + 32) / 3$ 
 $HA = H - 47$ 
 $HFA = H - 41$ 
**PROFILI A TERRA - FLOOR PROFILES - BODENPROFILE ▶ 106**
**A BX-PT-01** STANDARD  $HF = H - 35 = 1965$  mm

**H**  
 Altezza doccia  
 Shower height  
 Duschkabine Höhe

**LA**  
 Larghezza anta mobile  
 Sliding door width  
 Schiebeflügel Breite

**HA**  
 Altezza profilo verticale anta scorrevole  
 Vertical profile height sliding panel  
 Vertikalprofil Höhe Schiebeflügel

**LAF**  
 Larghezza anta fissa  
 Fixed panel width  
 Seitenteil Breite

**HFA**  
 Altezza profilo verticale anta fissa  
 Vertical profile height fixed panel  
 Vertikalprofil Höhe Seitenteil

**SET 5**

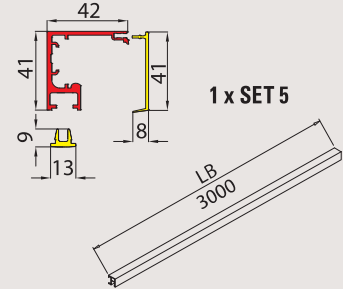
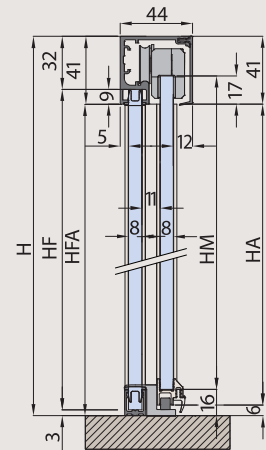
 DA TAGLIARE ✂  
 ADJUST THE LENGTH  
 BELIEBIG KÜRZBAR

 REGOLAZIONE RUOTA ± 2 MM.  
 ADJUSTMENT ± 2 MM.  
 VERSTELLUNG ± 2 MM.

 $HM = H - 40$   
 $HF = H - 35$ 
 $HA = H - 47$   
 $HFA = H - 41$ 
**OPTIONAL**

xme632q

SCORREVOLI

# BX-DIV5000 SET 6 L = 3000 MM

DOCCIA CON 2 VETRI FISSI E 2 MOBILI - SHOWER WITH 2 FIXED PANELS AND 2 SLIDING PANELS - DUSCHKABIN MIT 2 SEITENTEILEN UND 2 SCHIEBETÜREN

FINITURE - FINISHING - OBERFLÄCHEN: CR - NO - IX - BI - OR ▶ 22

**MY METALGLAS**

## COMPONENTI - COMPONENTS - EINZELTEILE

- BX-5000-C10** (2x)
- BX-5000-C30** (4x)
- BX-5000-C90 SX** (1x)  
**BX-5000-C90 DX** (1x)
- BX-DIV-550** (2x)
- BX-5006** (2x) **OPTIONAL SOFT-CLOSE**
- OPTIONAL** (2x)

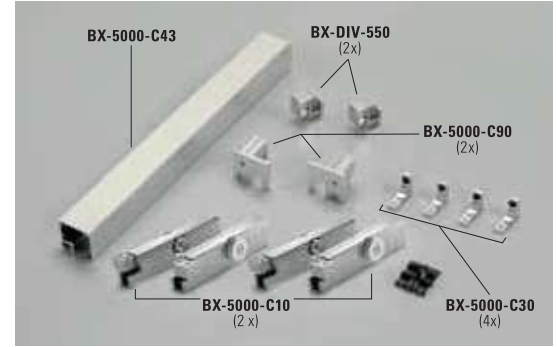

**CARATTERISTICHE COMPONENTI**  
FEATURES COMPONENTS - EIGENSCHAFTEN EINZELTEILE  
▶ 42

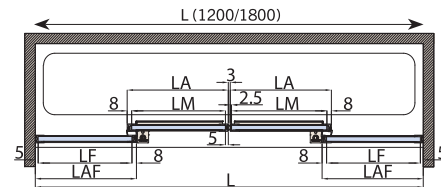
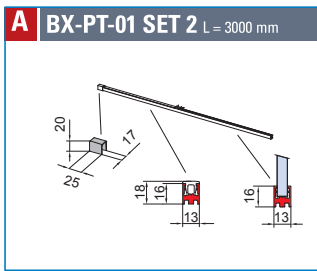

**PROFILI A TERRA**  
FLOOR PROFILES - BODENPROFILE  
▶ 106

xme632t

## LAVORAZIONE PROFILI ANTA - PANEL PROFILES PREPARATION - FLÜGELPROFILE BEARBEITUNG

**BX-DIV-ANT-C**

**MOBILE**

H MONTANTE = H-47  
L TRAVERSO = LA-32

**BX-DIV-ANT-E**

**MOBILE**

H MONTANTE = H-47  
L TRAVERSO = LA-32

**BX-DIV-ANT-B**

**FIXED**

H MONTANTE = H-57  
L TRAVERSO = LA-32

xme632a/xme632t

<p><b>L</b> Piatto Shower tray Duschtaße 40</p>	<p><b>LM</b> Larghezza vetro mobile Sliding glass width Glasbreite-Schiebeflügel</p>	<p><b>LF</b> Larghezza vetro fisso Side fixed glass width Festglasbreite</p>	<p><b>HM</b> Altezza vetro mobile Sliding glass height Schiebeflügel Höhe</p>	<p><b>HF</b> Altezza vetro fisso Side fixed glass height Glashöhe Festverglasung</p>
---	--	--	---	--

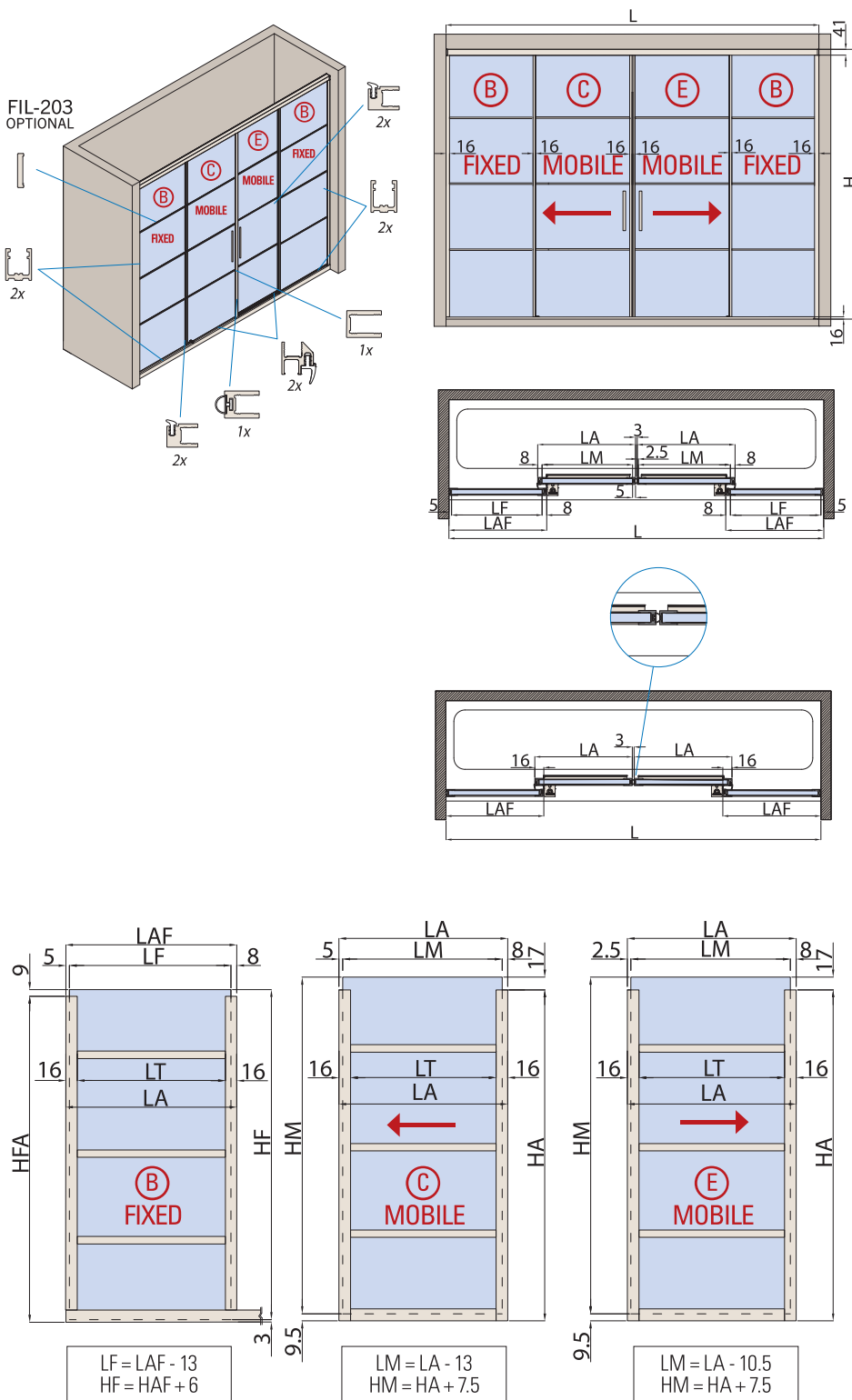
**LAVORAZIONE VETRO - GLASS PREPARATION - GLASBEARBEITUNG**

**CALCOLO VETRO - CALCULATION GLASS - GLASBERECHNUNG**

L = PIATTO - SHOWER TRAY - DUSCHTASSE

 $L1 = L - 3$ 
 $LA = LAF = (L1 + 32) / 4$ 
 $HA = H - 47$ 
 $HFA = H - 41$ 
**PROFILI A TERRA - FLOOR PROFILES - BODENPROFILE ▶ 106**
**A BX-PT-01** STANDARD HF = H - 35 = 1965 mm

xme632s

**H**  
 Altezza doccia  
 Shower height  
 Duschkabine Höhe

**LA**  
 Larghezza anta mobile  
 Sliding door width  
 Schiebeflügel Breite

**HA**  
 Altezza profilo verticale anta scorrevole  
 Vertical profile height sliding panel  
 Vertikalprofil Höhe Schiebeflügel

**LAF**  
 Larghezza anta fissa  
 Fixed panel width  
 Seitenteil Breite

**HFA**  
 Altezza profilo verticale anta fissa  
 Vertical profile height fixed panel  
 Vertikalprofil Höhe Seitenteil

**SET 6**

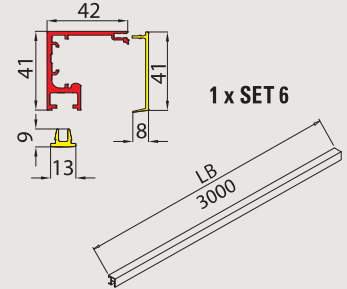
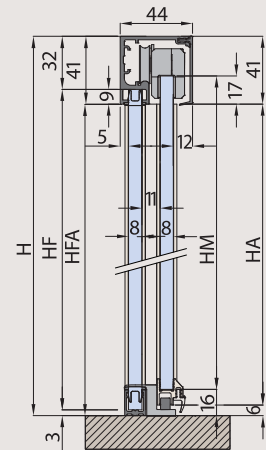
 DA TAGLIARE ✂  
 ADJUST THE LENGTH  
 BELIEBIG KÜRZBAR

 REGOLAZIONE RUOTA ± 2 MM.  
 ADJUSTMENT ± 2 MM.  
 VERSTELLUNG ± 2 MM.

HM = H - 40	HA = H - 47
HF = H - 35	HFA = H - 41

**OPTIONAL**

SCORREVOLI

# BX-DIV5000

## COMPONENTI - COMPONENTS - EINZELTEILE

SCORREVOLI



### BX-5000-C40/C43

- Binario con veletta, profilo di chiusura per sede vetro fisso BX-4001 incluso
- Track profile with cover, profile for fixed glass section BX-4001 included
- Laufschiene mit Profilabdeckung, Sichtschutzprofil für Seitenteil Sektor BX-4001 enthalten

CR - NO - IX - BI - OR

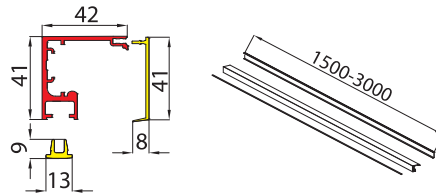

Cod.	Fin. / Fin. / Oberf.
BX-5000-C43-1500 mm	CR / NO / IX / BI / OR
BX-5000-C43-3000 mm	CR / NO / IX / BI / OR
BX-5000-C40-1000 x 1000 mm (2 pcs)	CR / NO / IX / BI / OR

xme632n



### BX-5000-C11

- Set composto da 2 carrelli (1 pc DX + 1 pc SX) per set 1
- Set consisting of 2 roller carriers (1 pc right + 1 pc left) for set 1
- Set bestehend aus 2 Klemm-Laufwagen (1 Stk Rechts + 1 Stk Links) für set 1

CR - NO

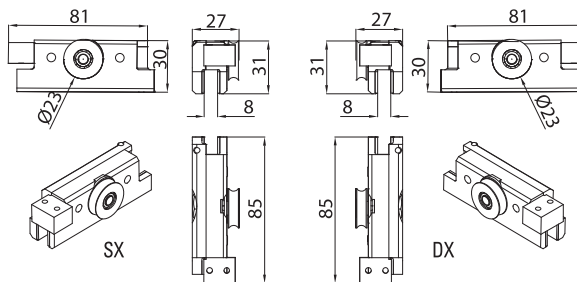

xme632n



### BX-5000-C10

- Set composto da 2 carrelli (1 pc DX + 1 pc SX) per set 2 - 3 - 4 - 5 - 6
- Set consisting of 2 roller carriers (1 pc right + 1 pc left) for set 2 - 3 - 4 - 5 - 6
- Set bestehend aus 2 Klemm-Laufwagen (1 Stk Rechts + 1 Stk Links) für set 2 - 3 - 4 - 5 - 6

CR - NO

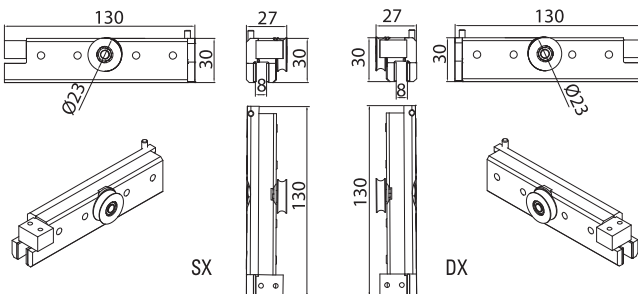

C-374-G1 NEW



### BX-5000-C90 DX

- Attacco a parete destro per binario
- Right wall connector for track profile
- Wandhalter rechts für Laufschiene

CR - NO - NS - BI - OR

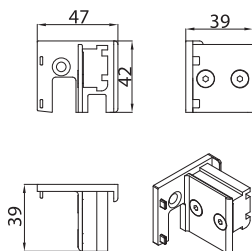

xme632n



### BX-5000-C90 SX

- Attacco a parete sinistro per binario
- Left wall connector for track profile
- Wandhalter links für Laufschiene

CR - NO - NS - BI - OR

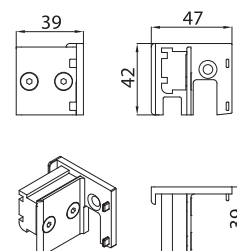

xme632n

**BX-5000-C81 DX**

- Piastrina destra attacco a vetro per BX-5000-C90
  - Right plate glass connector for BX-5000-C90
  - Platte Glashalter rechts für BX-5000-C90
- CR - NO - NS - BI - OR

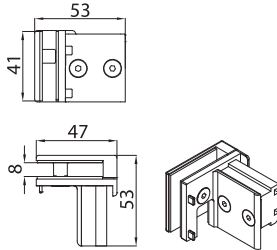

xme632n

**BX-5000-C81 SX**

- Piastrina sinistra attacco a vetro per BX-5000-C90
  - Left plate glass connector for BX-5000-C90
  - Platte Glashalter links für BX-5000-C90
- CR - NO - NS - BI - OR

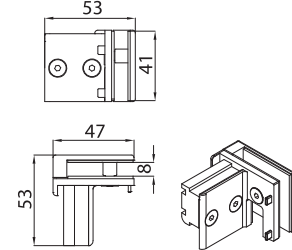

xme632n

**BX-5000-C20**

- Connettore ad angolo per binario per set 1
  - Corner connector for track profile set 1
  - Winkelverbinder Laufschiene set 1
- CR - NO - NS - BI - OR

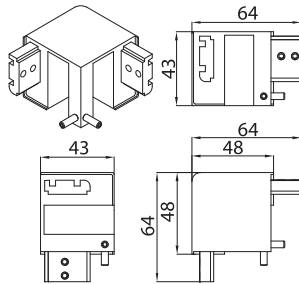

xme632n

**BX-5000-C30**

- Stopper
- AN

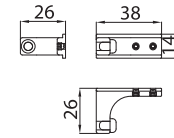

xme632n

**BX-DIV-550**

- Guida per anta intelaiata per applicazione con profilo a terra BX-PT-C58 sistema di sgancio della porta per facilitare la pulizia
  - Floor guide for framed panel for installation with floor profile BX-PT-C58 with quick release door function for easy cleaning
  - Gerahmte Tür Bodenführung für Montage mit Bodenprofil BX-PT-C58 mit auslosbarem System um das Reinigen zu erleichtern
- CR - NO - NS - BI - OR

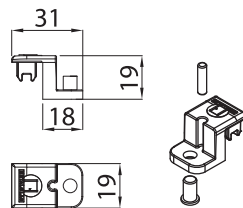

xme632n

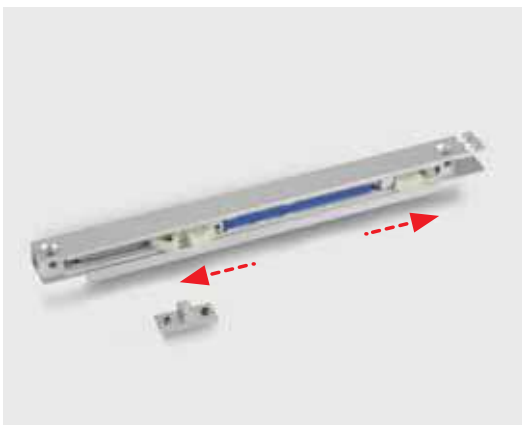
**BX-5006 Optional SOFT-CLOSE**

- Soft-close in apertura e chiusura
- Double acting Soft-close
- Soft-close doppelt Winkende

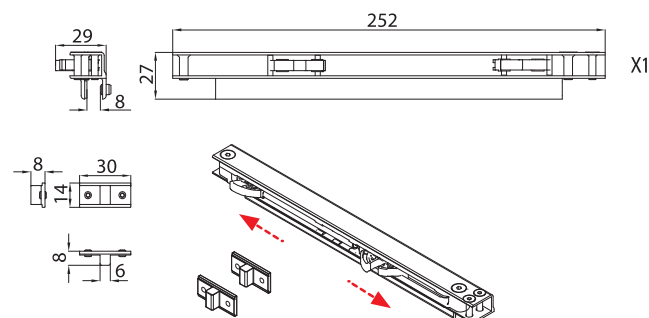

xme632n

## BX-DIV5000

### PROFILI ANTE - PANEL PROFILES - FLÜGELPROFILE

SCORREVOLI



#### BX-DIV502

- Profilo bordo vetro (componente anta D - E)
- Frame profile (component panel D - E)
- Rahmenprofil (Einzelteil Flügel D - E)

L = 3000 mm / L = 1000 mm

CR - NO - IX - BI - OR

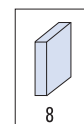
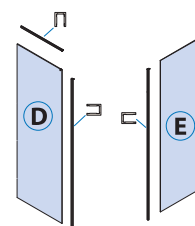
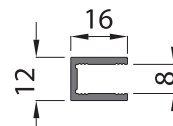
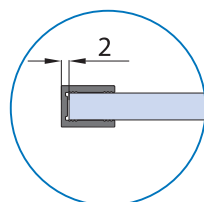

xme632o



#### BX-DIV526

- Profilo bordo vetro con guarnizione aletta laterale (componente anta A - B - C - E)
- Frame profile, gasket with side fin included (component panel A - B - C - E)
- Rahmenprofil mit Schiebetürdichtprofil (Einzelteil Flügel A - B - C - E)

L = 3000 mm

CR - NO - IX - BI - OR

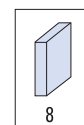
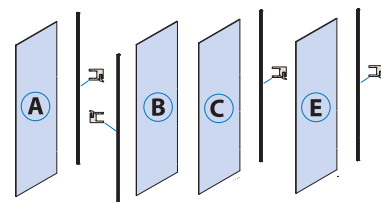
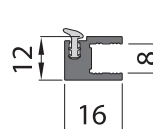
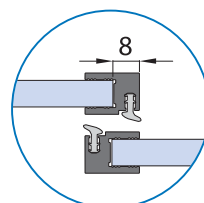

xme632o



#### BX-DIV527

- Profilo bordo vetro con guarnizione a palloncino (componente anta C)
- Frame profile with balloon gasket (component panel C)
- Rahmenprofil mit Dichtung (Einzelteil Flügel C)

L = 3000 mm

CR - NO - IX - BI - OR

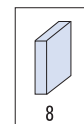
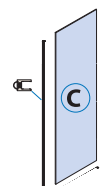
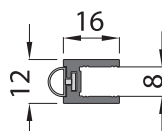
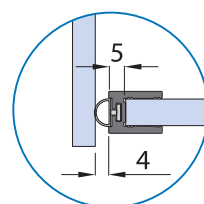

xme632o



#### BX-DIV543

- Paio profili bordo vetro con guarnizione magnetica per chiusura 90° (componente anta A)
- Pair frame profiles with 90° magnetic gaskets (component panel A)
- Paar Rahmenprofile mit 90° Magnetsdichtungen (Einzelteil Flügel A)

L = 3000 mm

CR - NO - IX - BI - OR

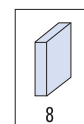
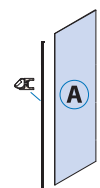
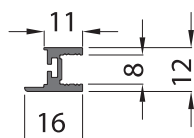
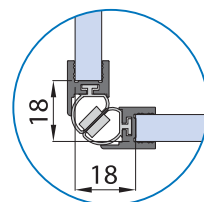

xme632o

**BX-DIV519**

- Profilo inferiore con guarnizione gocciolatoio (componente anta A - C - E)
- Bottom profile with drip flap seal gasket (component panel A - C - E)
- Rahmenprofil mit Lippe für den unteren Wannenanschluss (Einzelteil Flügel A - C - E)

L = 3000 mm / L = 1000 mm

CR - NO - IX - BI - OR

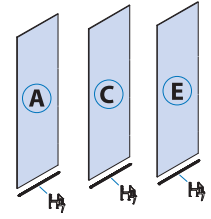
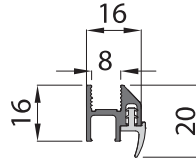
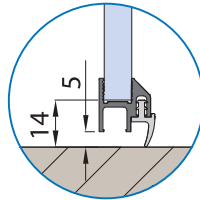

xme632o

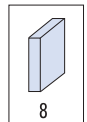

**FIL-203**

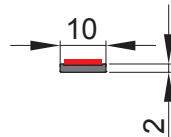
- Optional traverso
- Cross profile
- Querprofil

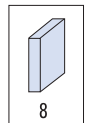

**Cod.**  
 Biadesivo preinstallato  
 Pre-installed  
 double-sided adhesive  
 Selbstklebend

xme595m

**BX-PT-C58**

- Profilo per fissaggio a terra o laterale
- Profile for floor and side installation
- Profil Boden- Wandmontage

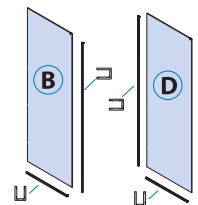
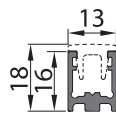

Cod.	Fin./Fin./Fin.
BX-PT-C58-1500 mm	CR - NO - IX - BI - OR
BX-PT-C58-3000 mm	CR - NO - IX - BI - OR

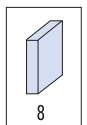
**BX-PT-C56**

- Coperchio per profilo a terra per tratto entrata doccia
- Cover profile for floor profile, shower entry.
- Profilabdeckung Bodenprofil Duscheinstieg

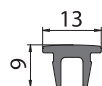

Cod.	Fin./Fin./Fin.
BX-PT-C56-1500 mm	CR - NO - IX - BI - OR
BX-PT-C56-3000 mm	CR - NO - IX - BI - OR

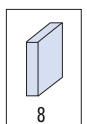

Con i profili bordatura e listelli Filo diventa molto semplice trasformare vetri fissi in séparé di carattere e design.

*Thanks to Filo edging and cross profiles, transforming fixed glass into design partitions with character becomes effortless.*

*Mit den Filo-Einfassprofilen und -Leisten wird es sehr einfach, Festverglasungen in ein Séparée mit Charakter und Design zu verwandeln.*



SCORREVOLI

BX-DIV502



FIL-203



BX-PF-02



B-328





**BX-PF-02**  
PROFILO A PARETE  
WALL PROFILE  
WANDANSCHLUSSPROFIL

**BX-DIV502**  
PROFILO PERIMETRALE  
FRAME PROFILE  
RAHMENPROFIL

**B-328-F**  
BARRA DI SUPPORTO  
SUPPORT BAR  
STABILISATIONSSTANGE

**FIL-203**  
LISTELLO  
CROSS PROFILE  
QUERPROFIL

**BOX DOCCIA - SHOWER BOX - DUSCHKABINE**  
SEPARÉ  
WALK-IN SYSTEM  
WALK-IN SYSTEM

**NO**  
FINITURA  
FINISHING  
OBERFLÄCHE



# BX-5000 TINY

## LA DOCCIA INVISIBILE

BX-5000 è il sistema per box doccia semplice e veloce.  
Semplice e veloce nel montaggio grazie all'assenza di lavorazioni nel vetro.  
Semplice e veloce da pulire con la possibilità di sgancio nella guida inferiore.

FUNZIONALITÀ PERFETTA E GRANDE IMPATTO ESTETICO.

- THE INVISIBLE SHOWER ENCLOSURE
- BX-5000 is a sliding shower enclosure without glass preparation and with optional soft-close closing system, easy and quickly to install. Release door function for easy cleaning.
- FUNCTIONALITY MEETS DESIGN.
- Unsichtbare Duschkabine
- Bx-5000, die Duschkabine ohne Glasbearbeitung, mit optionalem Dämpfung System, einfache und schnelle Montage. Die auslösbare Bodenführung erleichtert das Reinigen.
- Funktionalität trifft auf Design.



## PLUS

- BINARIO ALTO SOLO 40 MM
- MINIMAL E SEMPLICE DA MONTARE
- PINZE REGOLABILI IN ALTEZZA +/- 2,5 MM
- VETRO FISSO INGLOBATO NEL BINARIO
- POSSIBILITÀ DI SOFT-CLOSE SIA IN APERTURA CHE IN CHIUSURA
- DISTANZA TRA VETRO FISSO E MOBILE DI 11 MM
- POSSIBILITÀ DI SGANCIARE LA GUIDA INFERIORE PER UNA PERFETTA PULIZIA

- Rail only 40 mm high
- Minimal and easy to assemble
- Adjustable clamp height +/- 2,5 mm
- Fixed glass enclosed in the rail
- Possible soft-close in both opening and closure
- Only 11mm gap between panels
- Quick release door function for easy cleaning

- Schienenhöhe nur 40 mm
- Einfach und leicht zu montieren
- Höhenverstellbare Laufwagen +/- 2,5 mm
- Festes Glas in die Schiene eingebaut
- Soft-close beidseitig beim öffnen und schließen möglich
- Nur 11 mm Abstand zwischen den Glasscheiben
- Die auslösbare Bodenführung erleichtert das Reinigen

**BX-5000 TINY (OPTIONAL SOFT-CLOSE)**

NEW



SCORREVOLI



- Sistema scorrevole per box doccia disponibile per versioni in angolo, lineare e in nicchia.  
Possibilità di regolazione tramite ruota  $\pm 2,5$  mm. Optional soft-close
- Sliding system for shower box, available for corners, single doors or for niche installations. Adjustment of carrying wheels  $\pm 2,5$  mm. Optional soft-close
- Schiebetürsystem für Duschkabine, lieferbar für Eck-, Linear und Nischenduschen. Höheneinstellung der Räder  $\pm 2,5$  mm. Optional soft-close



SCORREVOLI

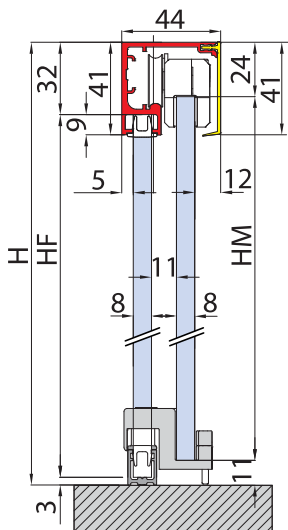
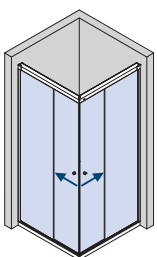
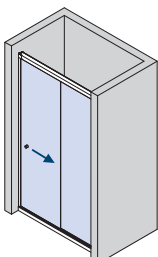
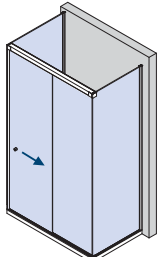
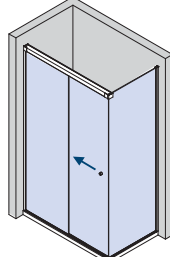
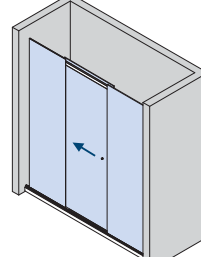
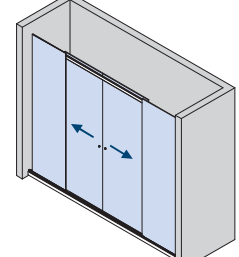

**SET 1**

**SET 2**

**SET 3**

**SET 4**

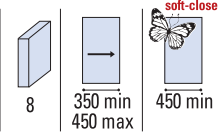
**SET 5**

**SET 6**

# BX-5000 SET 1

L = 1000 x 1000 mm

DOCCIA IN ANGOLO / CORNER SHOWER / ECKDUSCHE

MY METALGLAS



FINITURE  
FINISHING - OBERFLÄCHEN:  
CR - NO - IX - BI - OR ▶ 22

## COMPONENTI / COMPONENTS / EINZELTEILE

- BX-5000-C10 (2x)
- BX-5000-C30 (4x)
- BX-5000-C90 SX (1x)  
BX-5000-C90 DX (1x)
- BX-5000-C20 (1x)
- BX-3150 (2x)
- BX-5006 (2x) **OPTIONAL SOFT-CLOSE**
- OPTIONAL** (1x)

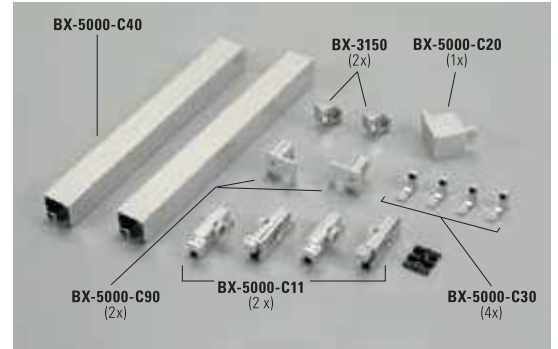
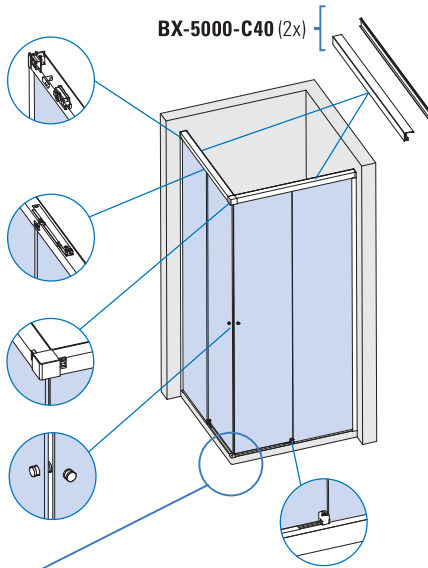

CARATTERISTICHE COMPONENTI /  
FEATURES COMPONENTS /  
EIGENSCHAFTEN EINZELTEILE ▶ 58

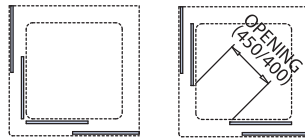
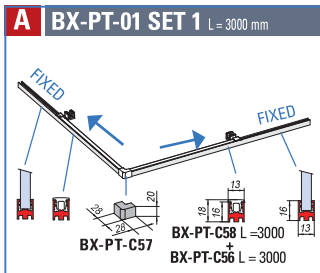

PROFILI A TERRA / FLOOR PROFILES / BODENPROFILE ▶ 106

xme628a

# BX-5000 SET 2

L = 1500 mm / L = 3000 mm

DOCCIA IN NICCHIA / NICHE SHOWER / NISCHENDUSCHE

MY METALGLAS

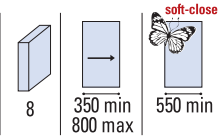

FINITURE  
FINISHING - OBERFLÄCHEN:  
CR - NO - IX - BI - OR ▶ 22

## COMPONENTI / COMPONENTS / EINZELTEILE

- BX-5000-C10 (1x)
- BX-5000-C30 (2x)
- BX-5000-C90 SX (1x)  
BX-5000-C90 DX (1x)
- BX-3150 (1x)
- BX-5006 (1x) **OPTIONAL SOFT-CLOSE**
- OPTIONAL** (1x)

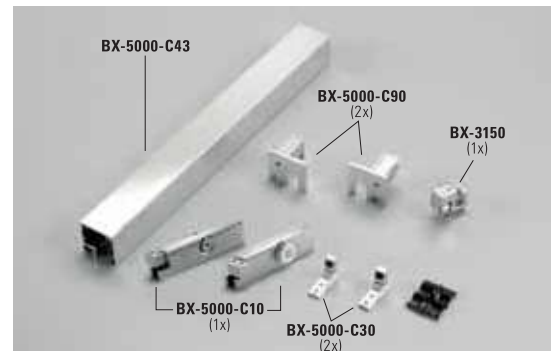
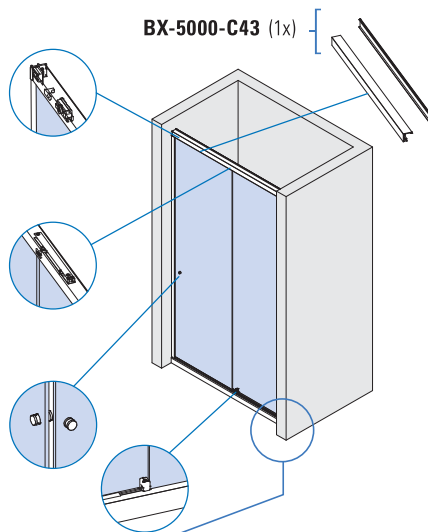

CARATTERISTICHE COMPONENTI /  
FEATURES COMPONENTS /  
EIGENSCHAFTEN EINZELTEILE ▶ 58

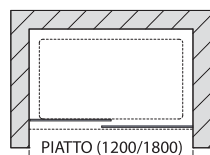
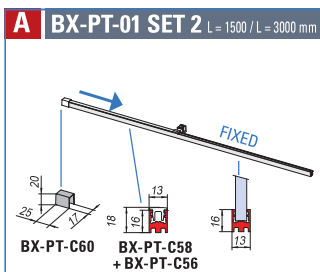

PROFILI A TERRA / FLOOR PROFILES / BODENPROFILE ▶ 106

xme628a

## LAVORAZIONE VETRO / GLASS PREPARATION / GLASBEARBEITUNG

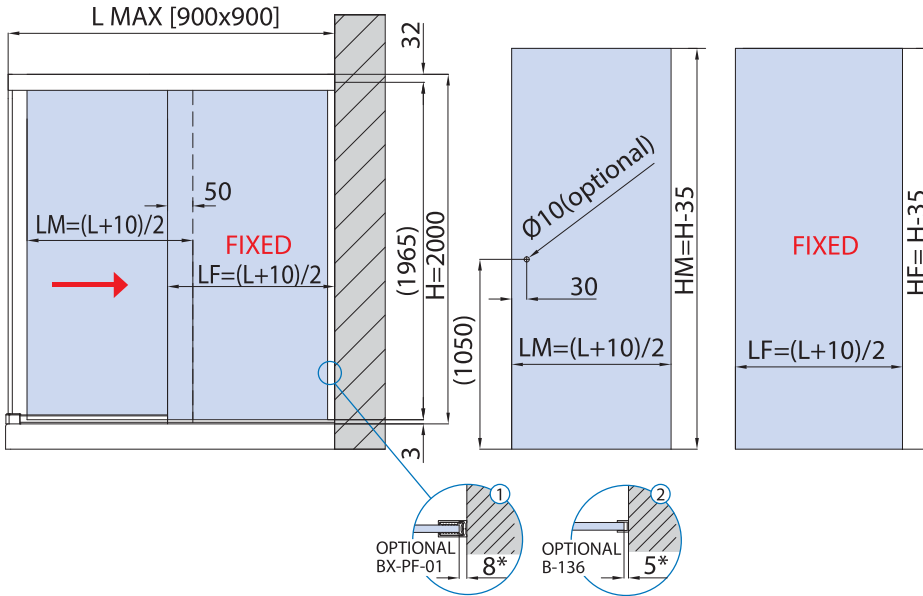

### CALCOLO VETRO / CALCULATION GLASS / GLASBERECHNUNG

PIATTO - SHOWER TRAY - DUSCHTASSE (L max) = 900 x 900 mm

$$LM = (L+10) / 2$$

$$LF = (L+10) / 2 - * \textcircled{1} / * \textcircled{2} \text{ (aria variabile / clearance / Spaltmaß)}$$

$$HM = H - 35 \text{ (1965)}$$

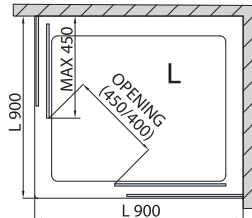

### PROFILI A TERRA / FLOOR PROFILES / BODENPROFILE ▶ 106

**A BX-PT-01** STANDARD HF = H - 35 = 1965 mm

xme628b

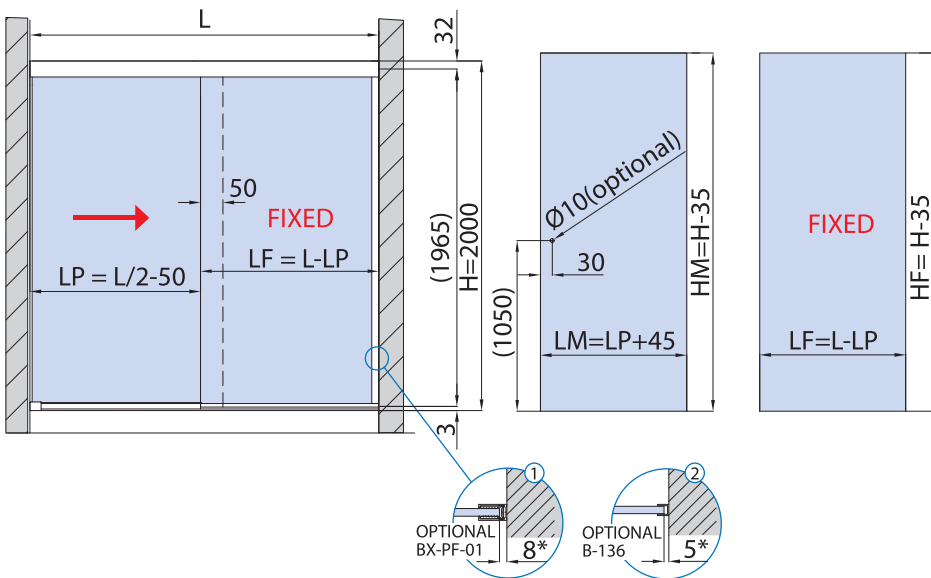

### CALCOLO VETRO / CALCULATION GLASS / GLASBERECHNUNG

L = PIATTO - SHOWER TRAY - DUSCHTASSE

$$LP = L / 2 - 50$$

$$LM = LP + 45$$

$$LF = L - LP - * \textcircled{1} / * \textcircled{2} \text{ (aria variabile / clearance / Spaltmaß)}$$

$$HM = H - 35 \text{ (1965)}$$

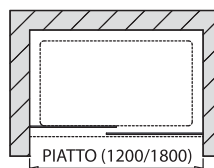

### PROFILI A TERRA / FLOOR PROFILES / BODENPROFILE ▶ 106

**A BX-PT-01** STANDARD HF = H - 35 = 1965 mm

xme628b

### SET 1 / SET 2

DA TAGLIARE / ADJUST THE LENGTH / BELIEBIG KÜRZBAR ✂

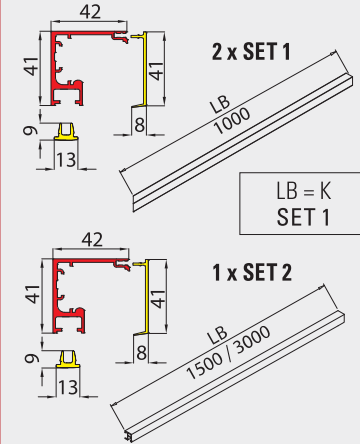

- Regolazione ruota ± 2,5 mm.
- Adjustment ± 2,5 mm.
- Verstellung ± 2,5 mm.

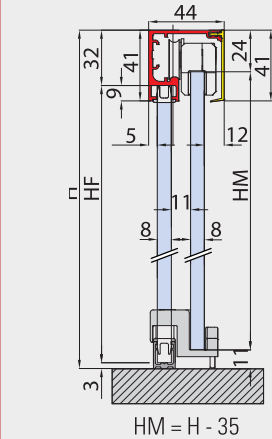

HF = H - 35  
solo per / only for / nur für  
**A BX-PT-01**

### OPTIONAL



L	LP	LM	LF	HM	HF	H
PIATTO Shower tray Duschtasse	Passaggio luce Clear opening width Lichte Durchgangsbreite	Larghezza vetro mobile Sliding glass width Schiebeflügel Breite	Larghezza vetro fisso Side fixed glass width Seitenteil Breite	Altezza vetro mobile Sliding glass height Schiebeflügel Höhe	Altezza vetro fisso Side fixed glass height Seitenteil Höhe	Altezza doccia Shower height Duschkabine Höhe

# BX-5000 SET 3

L = 1500 mm / L = 3000 mm  
DOCCIA A U / U SHOWER / U DUSCHE

MY METALGLAS

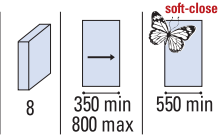

FINITURE  
FINISHING - OBERFLÄCHEN:  
CR - NO - IX - BI - OR ▶ 22

## COMPONENTI / COMPONENTS / EINZELTEILE

BX-5000-C10 (1x)

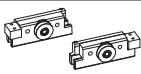

BX-5000-C30 (2x)



BX-5000-C90 SX (1x)



BX-5000-C90 DX (1x)



BX-5000-C81 SX (1x)



BX-5000-C81 DX (1x)



BX-3150 (1x)



BX-5006 (1x)



OPTIONAL  
SOFT-CLOSE

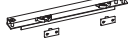

OPTIONAL (1x)

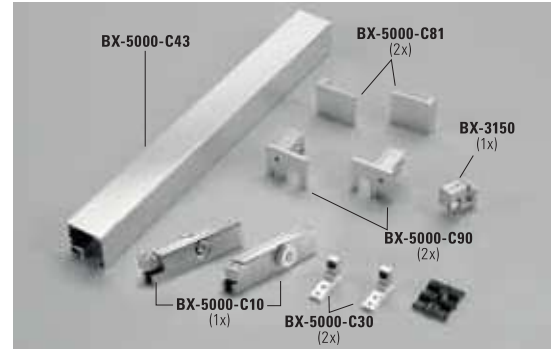
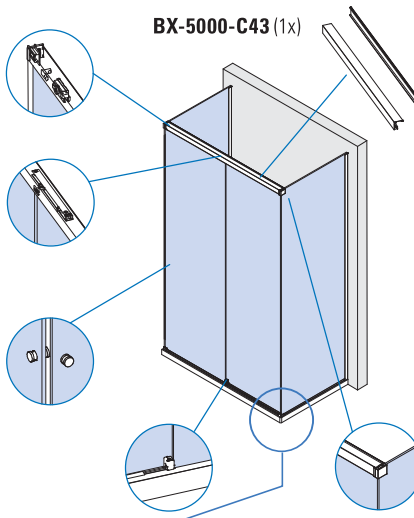

CARATTERISTICHE COMPONENTI /  
FEATURES COMPONENTS /  
EIGENSCHAFTEN EINZELTEILE ▶ 58

### A BX-PT-01 SET 3 L = 1500 / L = 3000 mm

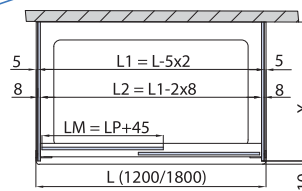
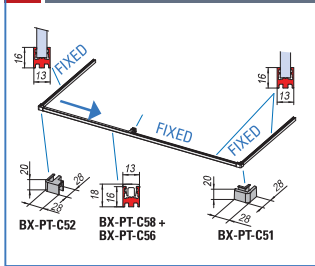

PROFILI A TERRA / FLOOR PROFILES / BODENPROFILE ▶ 106

xme628a

# BX-5000 SET 4

L = 1500 mm / L = 3000 mm  
DOCCIA CON SPALLA IN VETRO / CORNER SHOWER WITH 2  
FIXED PANEL / ECKDUSCHE MIT 2 FESTSTEHENDEN GLASTAFELN

MY METALGLAS

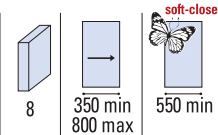

FINITURE  
FINISHING - OBERFLÄCHEN:  
CR - NO - IX - BI - OR ▶ 22

## COMPONENTI / COMPONENTS / EINZELTEILE

BX-5000-C10 (1x)

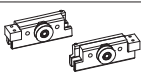

BX-5000-C30 (2x)



BX-5000-C90 SX (1x)



BX-5000-C90 DX (1x)



BX-5000-C81 SX/DX (1x)



BX-3150 (1x)



BX-5006 (1x)



OPTIONAL  
SOFT-CLOSE

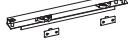

OPTIONAL (1x)

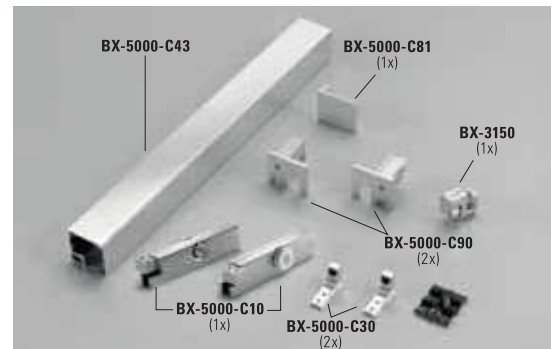
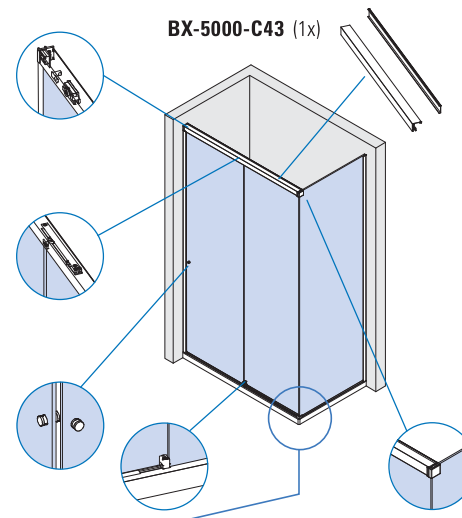

CARATTERISTICHE COMPONENTI /  
FEATURES COMPONENTS /  
EIGENSCHAFTEN EINZELTEILE ▶ 58

### A BX-PT-01 SET 4 L = 1500 / L = 3000 mm

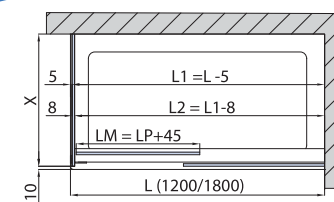
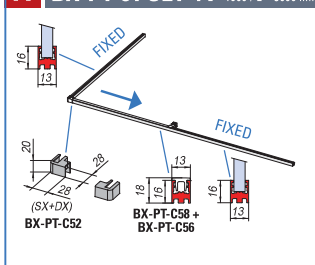

PROFILI A TERRA / FLOOR PROFILES / BODENPROFILE ▶ 106

xme628a



# BX-5000 SET 5

L = 3000 mm  
DOCCIA A U / U SHOWER / U DUSCHE

MY METALGLAS

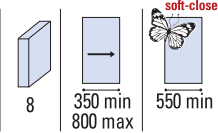

FINITURE  
FINISHING - OBERFLÄCHEN:  
CR - NO - IX - BI - OR ▶ 22

## COMPONENTI / COMPONENTS / EINZELTEILE

BX-5000-C10 (1x)



BX-5000-C30 (2x)



BX-5000-C90 SX (1x)  
BX-5000-C90 DX (1x)



BX-3150 (1x)



BX-5006 (1x)  
OPTIONAL  
SOFT-CLOSE



OPTIONAL (1x)

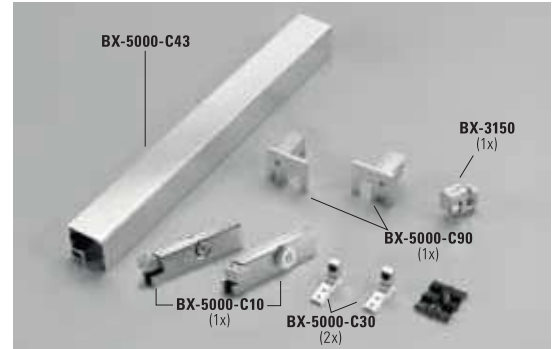
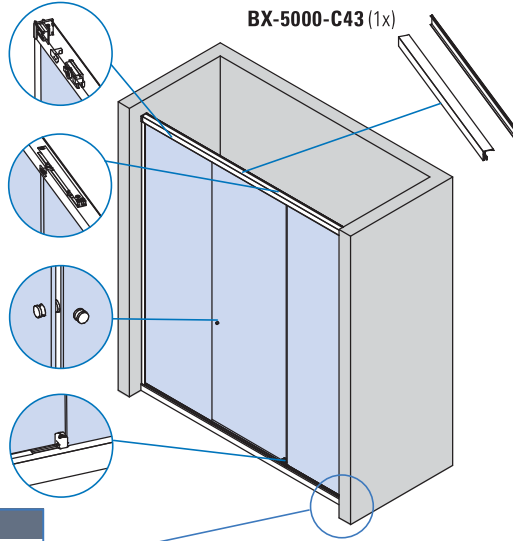

CARATTERISTICHE COMPONENTI /  
FEATURES COMPONENTS /  
EIGENSCHAFTEN EINZELTEILE ▶ 58

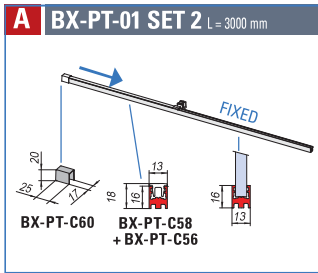

PROFILI A TERRA / FLOOR PROFILES / BODENPROFILE ▶ 106

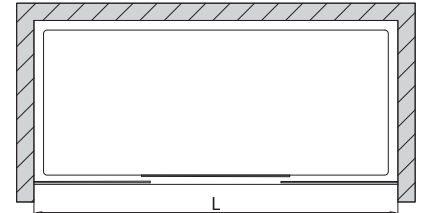

xme628e

# BX-5000 SET 6

L = 3000 mm  
DOCCIA CON SPALLA IN VETRO / CORNER SHOWER WITH 2  
FIXED PANEL / ECKDUSCHE MIT 2 FESTSTEHENDEN GLASTAFELN

MY METALGLAS

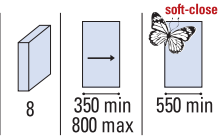

FINITURE  
FINISHING - OBERFLÄCHEN:  
CR - NO - IX - BI - OR ▶ 22

## COMPONENTI / COMPONENTS / EINZELTEILE

BX-5000-C10 (2x)

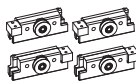

BX-5000-C30 (4x)



BX-5000-C90 SX (1x)  
BX-5000-C90 DX (1x)



BX-3150 (2x)



BX-5006 (2x)  
OPTIONAL  
SOFT-CLOSE



OPTIONAL (2x)

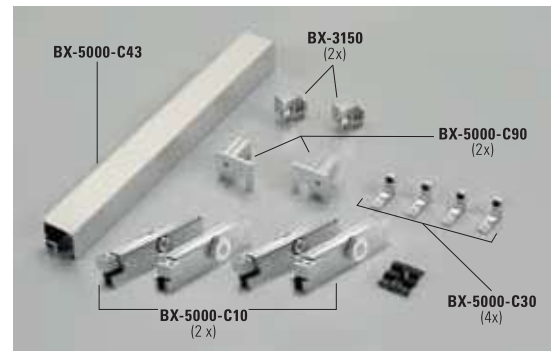
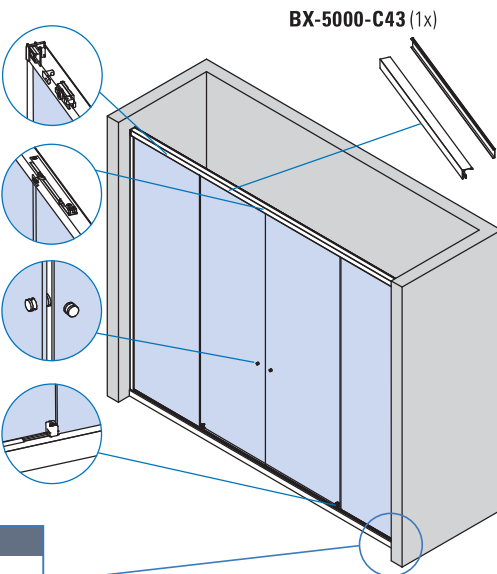

CARATTERISTICHE COMPONENTI /  
FEATURES COMPONENTS /  
EIGENSCHAFTEN EINZELTEILE ▶ 58

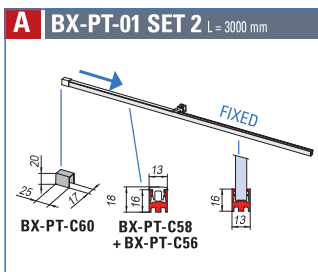

PROFILI A TERRA / FLOOR PROFILES / BODENPROFILE ▶ 106

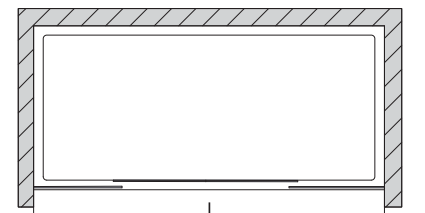

xme628f

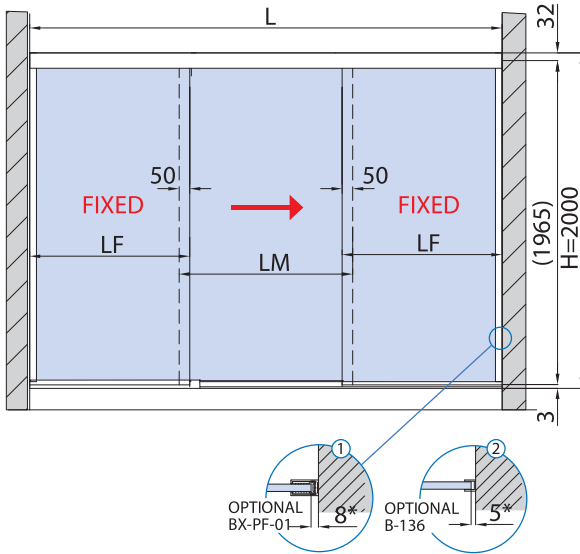
**LAVORAZIONE VETRO / GLASS PREPARATION / GLASBEARBEITUNG**

**CALCOLO VETRO / CALCULATION GLASS / GLASBERECHNUNG**

L = PIATTO - SHOWER TRAY - DUSCHASSE  
 LM = LF = (L + 100) / 3  
 LF = LF - \* (1) / \* (2)  
 (aria variabile / clearance / Spaltmaß)  
 HM = H - 35 = 1965 mm

**PROFILI A TERRA / FLOOR PROFILES / BODENPROFILE ▶ 106**

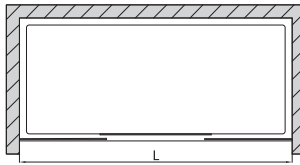
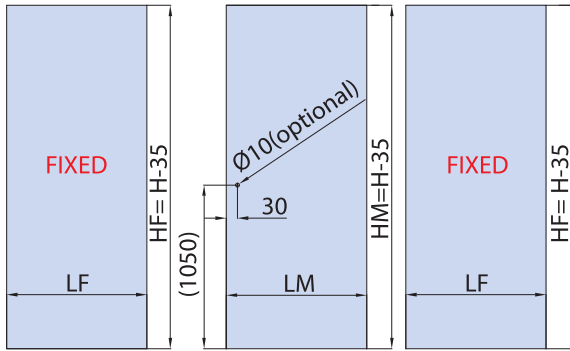
▲ BX-PT-C58  
 STANDARD HF = H - 35 = 1965 mm

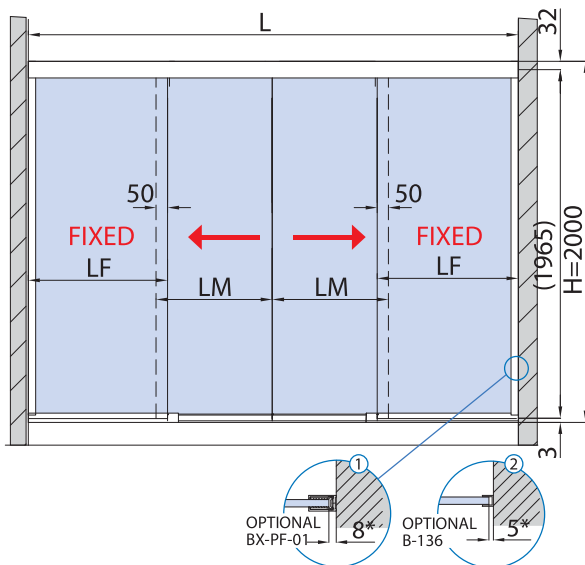

xme628e

**CALCOLO VETRO / CALCULATION GLASS / GLASBERECHNUNG**

L = PIATTO - SHOWER TRAY - DUSCHASSE  
 LM = LF = (L + 100) / 4  
 LF = LF - \* (1) / \* (2)  
 (aria variabile / clearance / Spaltmaß)  
 HM = H - 35 = 1965 mm

**PROFILI A TERRA / FLOOR PROFILES / BODENPROFILE ▶ 106**

▲ BX-PT-C58  
 STANDARD HF = H - 35 = 1965 mm

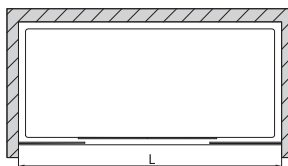
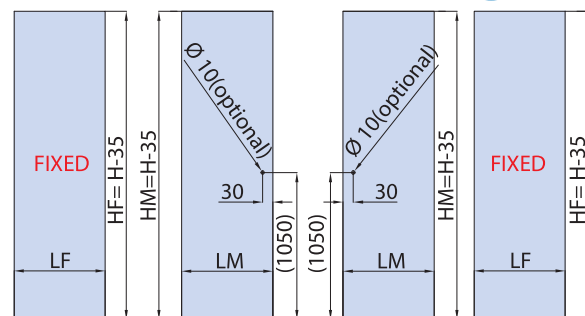

xme628f

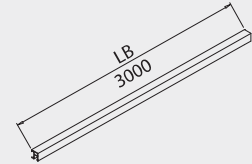
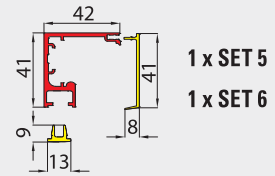
**SET 5 / SET 6**
**DA TAGLIARE / ADJUST THE LENGTH / BELIEBIG KÜRZBAR ✂**

- Regolazione ruota ± 2,5 mm.
- Adjustment ± 2,5 mm.
- Verstellung ± 2,5 mm.

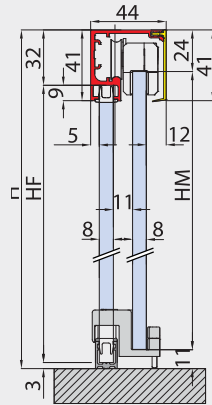

HM = H - 35

HF = H - 35  
 solo per / only for / nur für  
 ▲ BX-PT-01

**OPTIONAL**

L	LP	LM	LF	HM	HF	H	HFL
Piatto Shower tray Duschasse	Passaggio luce Clear opening width Lichte Durchgangsbreite	Larghezza vetro mobile Sliding glass width Schiebeflügel Breite	Larghezza vetro fisso Side fixed glass width Seitenteil Breite	Altezza vetro mobile Sliding glass height Schiebeflügel Höhe	Altezza vetro fisso Side fixed glass height Seitenteil Höhe	Altezza doccia Shower height Duschkabine Höhe	Altezza vetro fisso laterale Side fixed glass height Seitenteil (seitlich) Höhe

# BX-5000

## COMPONENTI / COMPONENTS / EINZELTEILE

SCORREVOLI

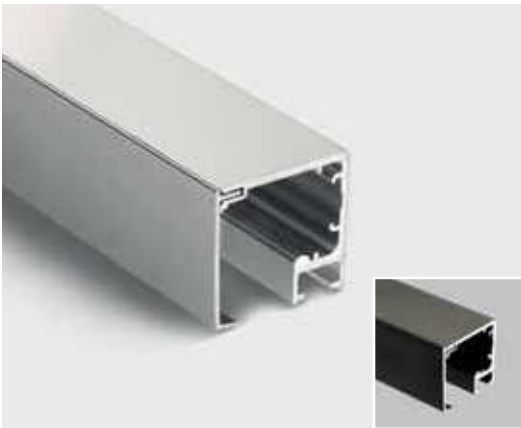

### BX-5000-C40/C43

- Binario con veletta, profilo di chiusura per sede vetro fisso BX-4001 incluso
- Track profile with cover, profile for fixed glass section BX-4001 included
- Laufschiene mit Profilabdeckung, Sichtschutzprofil für Seitenteil Sektor BX-4001 enthalten

CR - NO - IX - BI - OR

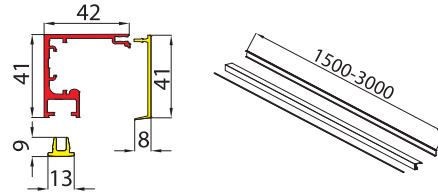

Cod.	Fin. / Fin. / Oberf.
BX-5000-C43-1500 mm	CR / NO / IX / BI / OR
BX-5000-C43-3000 mm	CR / NO / IX / BI / OR
BX-5000-C40-1000 x 1000 mm (2 pcs)	CR / NO / IX / BI / OR

xme628d



### BX-5000-C11

- Set composto da 2 carrelli (1 pc DX + 1 pc SX) per set 1
- Set consisting of 2 roller carriers (1 pc right + 1 pc left) for set 1
- Set bestehend aus 2 Klemm-Laufwagen (1 Stk Rechts + 1 Stk Links) für set 1

CR - NO

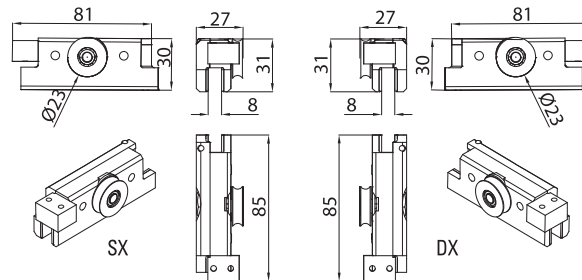

xme632n



### BX-5000-C10

- Set composto da 2 carrelli (1 pc DX + 1 pc SX) per set 2 - 3 - 4 - 5 - 6
- Set consisting of 2 roller carriers (1 pc right + 1 pc left) for set 2 - 3 - 4 - 5 - 6
- Set bestehend aus 2 Klemm-Laufwagen (1 Stk Rechts + 1 Stk Links) für set 2 - 3 - 4 - 5 - 6

CR - NO

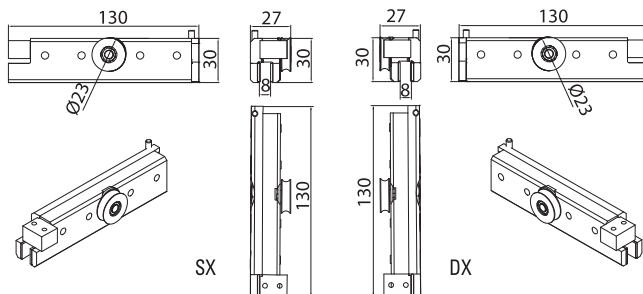

C-374-G1 NEW



### BX-5000-C90 DX

- Attacco a parete destro per binario
- Right wall connector for track profile
- Wandhalter rechts für Laufschiene

CR - NO - NS - BI - OR

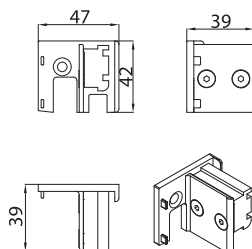

xme628d



### BX-5000-C90 SX

- Attacco a parete sinistro per binario
- Left wall connector for track profile
- Wandhalter links für Laufschiene

CR - NO - NS - BI - OR

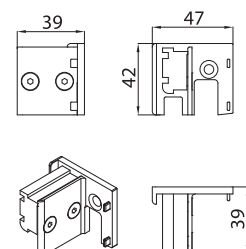

xme628d

**BX-5000-C81 DX**

- Piastrina destra attacco a vetro per BX-5000-C90
  - Right plate glass connector for BX-5000-C90
  - Platte Glashalter rechts für BX-5000-C90
- CR - NO - NS - BI - OR

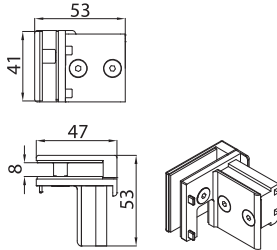

xme628d

**BX-5000-C81 SX**

- Piastrina sinistra attacco a vetro per BX-5000-C90
  - Left plate glass connector for BX-5000-C90
  - Platte Glashalter links für BX-5000-C90
- CR - NO - NS - BI - OR

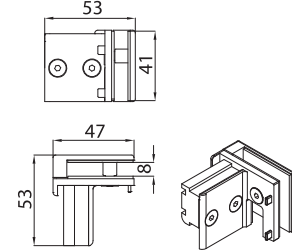

xme628d

**BX-5000-C30**

- Stopper
- AN

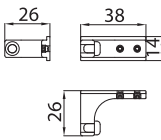

xme628d

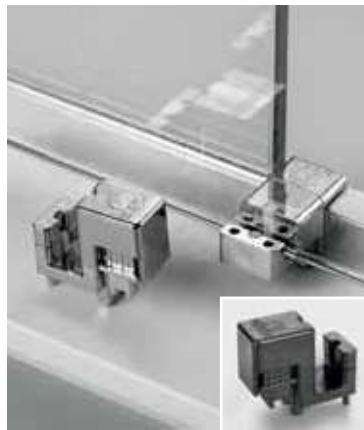
**BX-3150**

- Guida vetro scorrevole BX-3150 per applicazione con profilo a terra BX-PT-C58 sistema di sgancio della porta per facilitare la pulizia.
  - Floor guide sliding panel BX-3150 for installation with floor profile BX-PT-C58 with quick release door function for easy cleaning.
  - Schiebetür Bodenführung BX-3150 für Montage mit Bodenprofil BX-PT-C58 mit auslosbarem System um das Reinigen zu erleichtern.
- CR - NO - NS - BI - OR

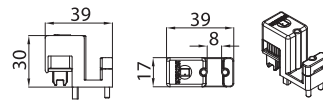

xme628d

**BX-5000-C20**

- Connettore ad angolo per binario per set 1
  - Corner connector for track profile set 1
  - Winkelverbinder Laufschiene set 1
- CR - NO - NS - BI - OR

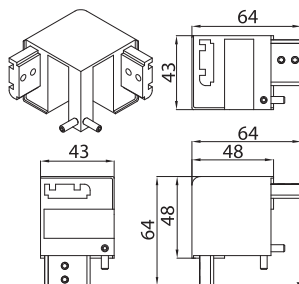

xme628d

**BX-5006 Optional SOFT-CLOSE**

- Soft-close in apertura e chiusura
- Double acting Soft-close
- Soft-close doppelt Winkende

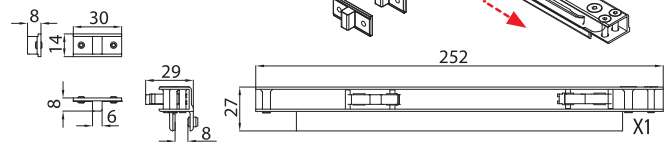

xme628d

**BX PT-C58**

- Profilo per fissaggio a terra o laterale
- Profile for floor and side installation
- Profil Boden Wand-Montage

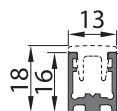
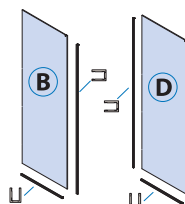

Cod.	Fin./Fin./Fin.
BX-PT-C58-1500 mm	CR - NO - IX - BI - OR
BX-PT-C58-3000 mm	CR - NO - IX - BI - OR

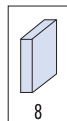
**BX PT-C56**

- Coperchio per profilo a terra per tratto entrata doccia
- Cover profile for floor profile, shower entry.
- Profilabdeckung Bodenprofil Duscheinstieg

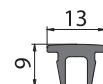

Cod.	Fin./Fin./Fin.
BX-PT-C56-1500 mm	CR - NO - IX - BI - OR
BX-PT-C56-3000 mm	CR - NO - IX - BI - OR

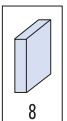



SCORREVOLI

# LINEA BX-4000

## IL BOX DOCCIA MINIMAL E SEMPLICE DA MONTARE

BX-4000 LINEA è il sistema scorrevole per box doccia disponibile nelle versioni ad angolo, lineare e a nicchia. Eleganza e perfezione estetica e funzionale caratterizzano uno tra i brevetti di maggior successo dell'azienda Metalglas.

DESIGN E INNOVAZIONE SENZA PRECEDENTI.

### MINIMAL AND EASY TO ASSEMBLE

A sliding system for shower enclosure, available for corner, niche or U-shower installations. Elegance, functionality and essentiality for an exclusive patented concept.

### UNIQUE DESIGN AND INNOVATION

### EINFACH UND LEICHT ZU MONTIEREN

Schiebetürsysteme für Duschkabine, lieferbar für Eck- Nische- und U-Dusche. Funktionalität und minimale Eleganz für ein exklusives und patentiertes Konzept.

### EINZIGARTIGES DESIGN UND INNOVATION.



## PLUS

- CONCEPT E BREVETTO ESCLUSIVO
- BINARIO ALTO SOLO 26 MM
- ELEGANTE FUNZIONALE ESSENZIALE
- FACILE DA MONTARE
- POSSIBILITÀ DI SGANCIARE LA GUIDA INFERIORE PER UNA PERFETTA PULIZIA
- PINZE REGOLABILI IN ALTEZZA +/- 2,5MM

- Exclusive patented concept
- Rail only 26 mm high
- Elegant, functional, essential
- Easy to assemble
- Quick release door function for easy cleaning
- +/- 2,5 mm clamps adjustment

- Exclusives und patentiertes Konzept
- Schienenhöhe nur 26 mm
- Qualität, Optik, Funktionalität
- Einfache Montage
- Die auslösbare Bodenführung erleichtert das Reinigen
- Höhenverstellbare Laufwagen +/- 2,5 mm

## BX-4000 LINEA 30

- Sistema scorrevole per box doccia, altezza binario solo 26 mm, disponibile per versioni in angolo, lineare e in nicchia. Materiale: alluminio. Finitura: cromo lucido, nero opaco e oro opaco.
- Sliding system for shower box, track profile's height only 26 mm, available for corners, single doors or for niche installations. Material: aluminium. Finish: polished chrome, matt black and matt gold.
- Schiebetüresystem für Duschkabine, Laufschiene Höhe nur 26 mm, lieferbar für Eck-, Linear und Nischenduschen. Material: Aluminium. Oberfläche: chrom poliert, matt schwarz and matt gold.



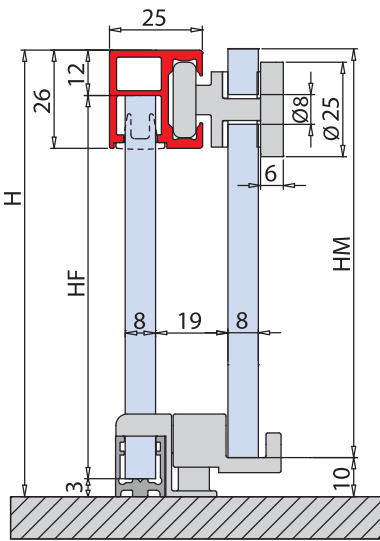

SET 1

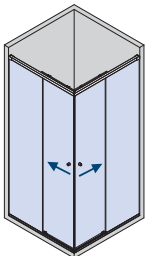

SET 2

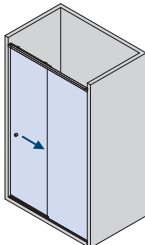

SET 3

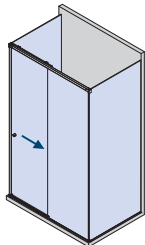

SET 4

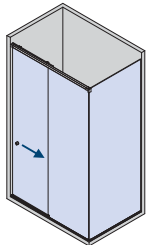

SET 5

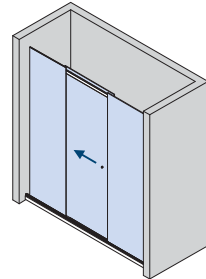

SET 6

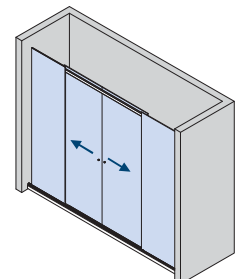

## BX-4000 LINEA 30 SET 1

L = 1000 x 1000 mm

DOCCIA IN ANGOLO / CORNER SHOWER / ECKDUSCHE

MY METALGLAS

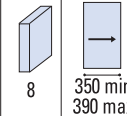

Fin. / Fin. / Oberf.

CR	NO
Cromo lucido	Nero opaco
Polished chrome	Matt black
Chrom glänzend	Matt schwarz

### COMPONENTI / COMPONENTS / EINZELTEILE

BX-4000-C30 (2x)

BX-4000-C10 (4x)

BX-4000-C90 (2x)

BX-4000-C20 (1x)

OPTIONAL

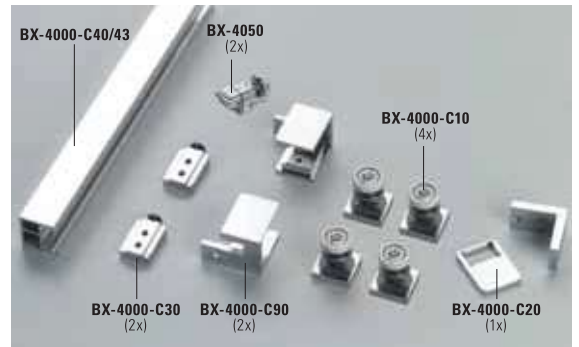
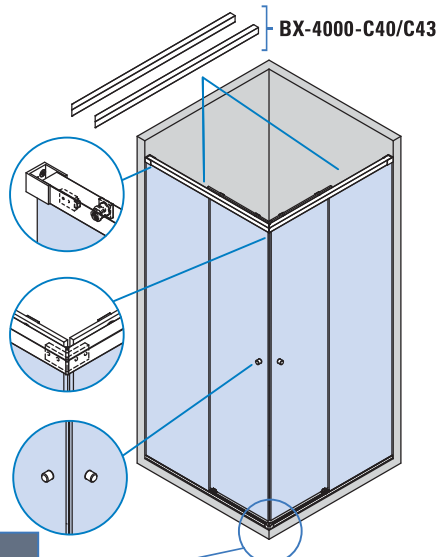

CARATTERISTICHE COMPONENTI /  
FEATURES COMPONENTS /  
EIGENSCHAFTEN EINZELTEILE ▶ 70

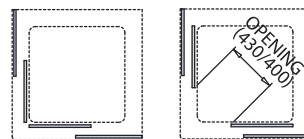
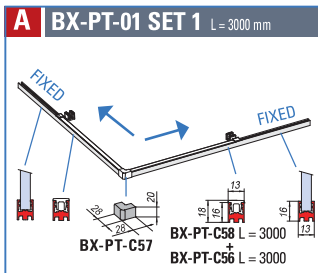

PROFILI A TERRA / FLOOR PROFILES / BODENPROFILE ▶ 106

xme512a

## BX-4000 LINEA 30 SET 2

L = 1500 mm / L = 3000 mm

DOCCIA IN NICCHIA / NICHE SHOWER / NISCHENDUSCHE

MY METALGLAS

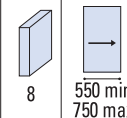

Fin. / Fin. / Oberf.

CR	NO
Cromo lucido	Nero opaco
Polished chrome	Matt black
Chrom glänzend	Matt schwarz

### COMPONENTI / COMPONENTS / EINZELTEILE

BX-4000-C30 (1x)

BX-4000-C10 (2x)

BX-4000-C90 (2x)

OPTIONAL

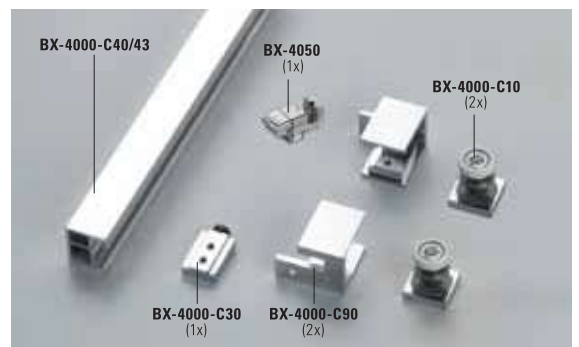
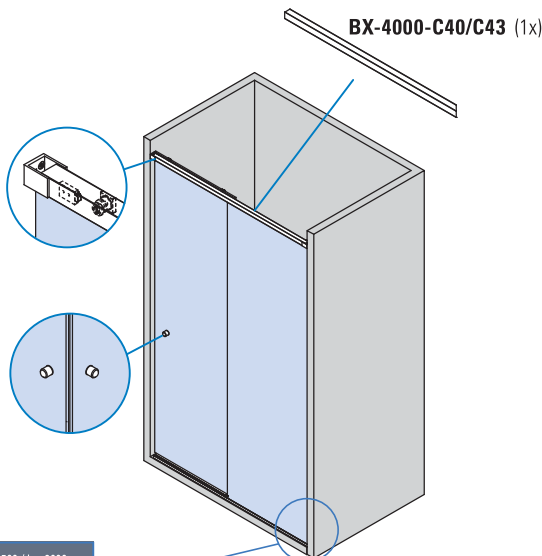

CARATTERISTICHE COMPONENTI /  
FEATURES COMPONENTS /  
EIGENSCHAFTEN EINZELTEILE ▶ 70

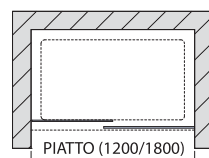
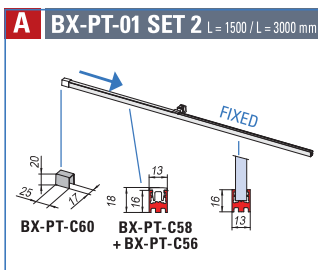

PROFILI A TERRA / FLOOR PROFILES / BODENPROFILE ▶ 106

xme512a

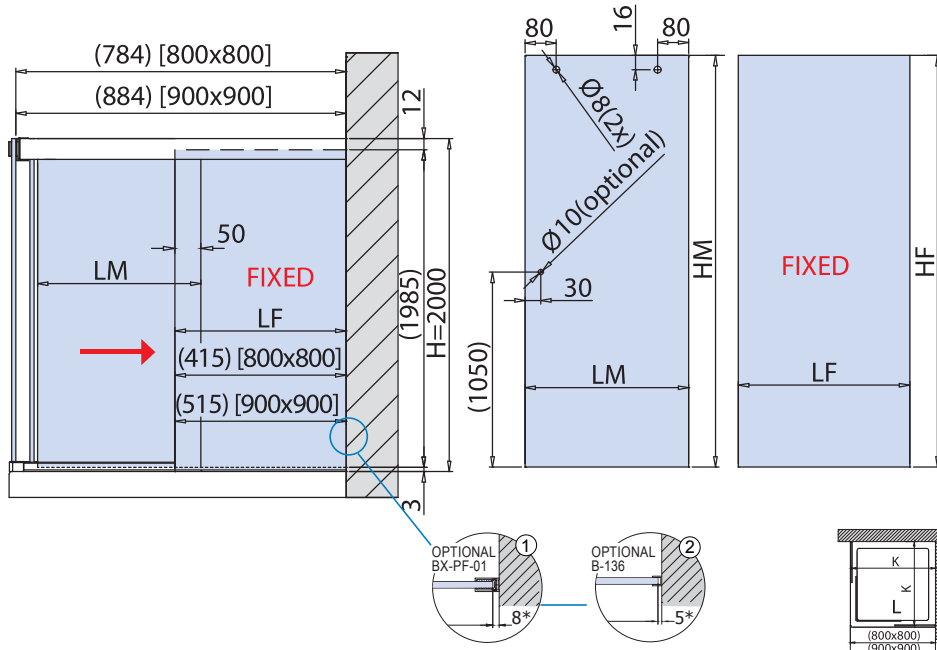
**LAVORAZIONE VETRO / GLASS PREPARATION / GLASBEARBEITUNG**

**CALCOLO VETRO / CALCULATION GLASS / GLASBERECHNUNG**

L = 800 x 800 mm (900 x 900) mm

LM = L / 2

LF = [(L / 2)] - (aria variabile / clearance / Spaltmaß)

HM = H - 10 = 1990 mm

**PROFILI A TERRA / FLOOR PROFILES / BODENPROFILE ▶ 106**

**A BX-PT-01** STANDARD HF = H - 15 = 1985 mm

xme512b

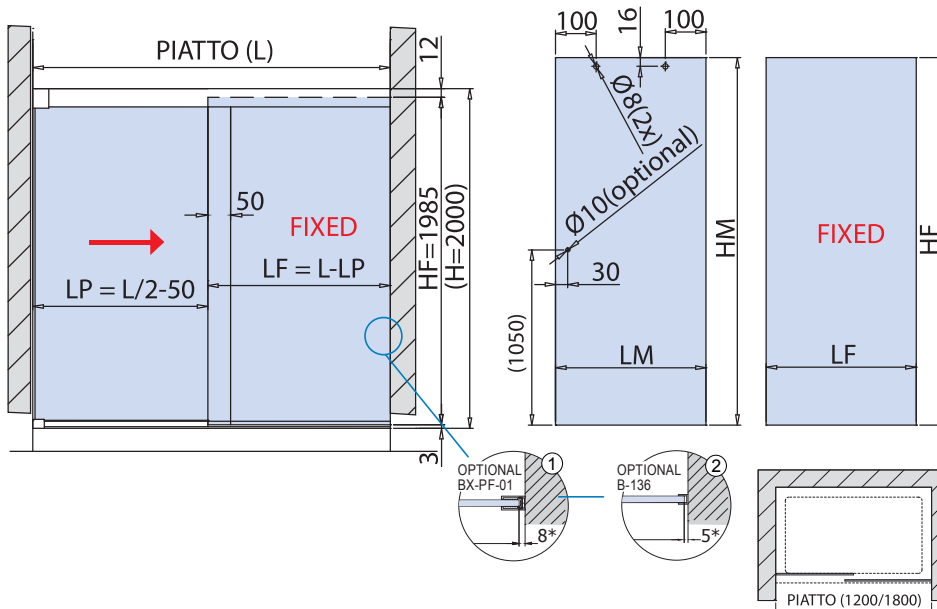
**CALCOLO VETRO / CALCULATION GLASS / GLASBERECHNUNG**

L = PIATTO DOCCIA - SHOWER TRAY - DUSCHTASSE

LP = L / 2 - 50

LM = LP + 45

LF = L - LP - (aria variabile / clearance / Spaltmaß)

HM = H - 10 = 1990 mm

**PROFILI A TERRA / FLOOR PROFILES / BODENPROFILE ▶ 106**

**A BX-PT-01** STANDARD HF = H - 15 = 1985 mm

xme512b

**SET 1 / SET 2**

DA TAGLIARE / ADJUST THE LENGTH / BELIEBIG KÜRZBAR ✂

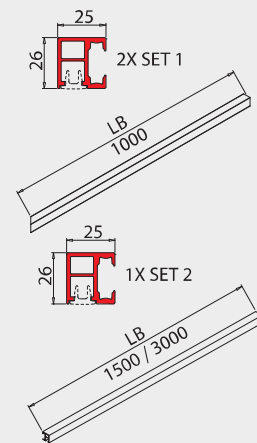

- Regolazione ruota ± 2,5 mm.
- Adjustment ± 2,5 mm.
- Verstellung ± 2,5 mm.

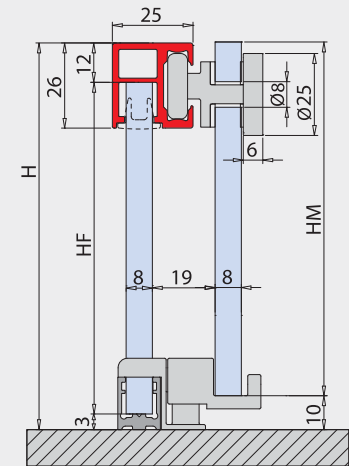

HM = H - 10  
HF = H - 15  
solo per / only for / nur für  
**A BX-PT-01**

**OPTIONAL**



L	LP	LM	LF	HM	HF	H
Piatto Shower tray Duschtasse	Passaggio luce Clear opening width Lichte Durchgangsbreite	Larghezza vetro mobile Sliding glass width Schiebeflügel Breite	Larghezza vetro fisso Side fixed glass width Seitenteil Breite	Altezza vetro mobile Sliding glass height Schiebeflügel Höhe	Altezza vetro fisso Side fixed glass height Seitenteil Höhe	Altezza doccia Shower height Duschkabine Höhe

SCORREVOLI

# BX-4000 LINEA 30 SET 3

L = 1500 mm / L = 3000 mm  
DOCCIA A U / U SHOWER / U DUSCHE

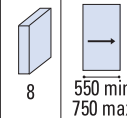
MY METALGLAS



Fin. / Fin. / Oberf.

CR	NO
Cromo lucido	Nero opaco
Polished chrome	Matt black
Chrom glänzend	Matt schwarz

## COMPONENTI / COMPONENTS / EINZELTEILE

BX-4000-C30 (1x)

BX-4000-C10 (2x)

BX-4000-C90 (2x)

BX-4000-C81 (2x)

OPTIONAL

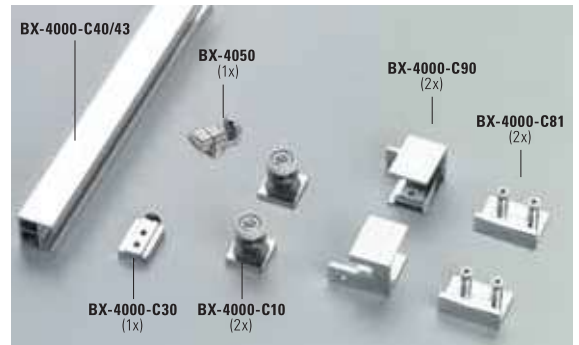
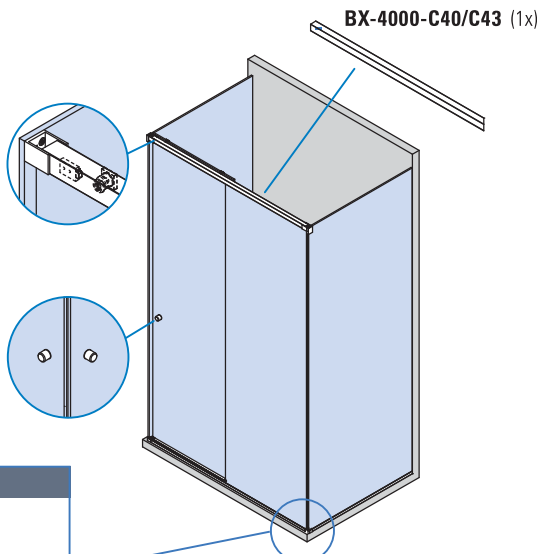

CARATTERISTICHE COMPONENTI /  
FEATURES COMPONENTS /  
EIGENSCHAFTEN EINZELTEILE ▶ 70

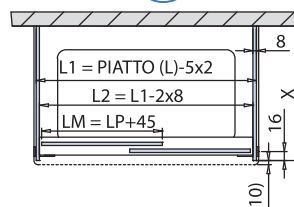
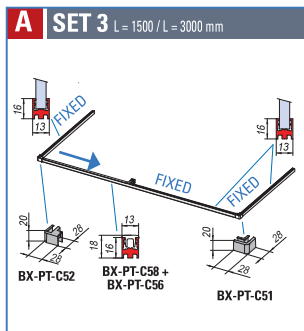

PROFILI A TERRA / FLOOR PROFILES / BODENPROFILE ▶ 106

xme512a

# BX-4000 LINEA 30 SET 4

L = 1500 mm / L = 3000 mm  
DOCCIA CON SPALLA IN VETRO / CORNER SHOWER WITH 2 FIXED PANEL  
ECKDUSCHE MIT 2 FESTSTEHENDEN GLASTAFELN

MY METALGLAS

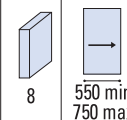

Fin. / Fin. / Oberf.

CR	NO
Cromo lucido	Nero opaco
Polished chrome	Matt black
Chrom glänzend	Matt schwarz

## COMPONENTI / COMPONENTS / EINZELTEILE

BX-4000-C30 (1x)

BX-4000-C10 (1x)

BX-4000-C90 SX (1x)

BX-4000-C90 DX (1x)

BX-4000-C81 (1x)

OPTIONAL

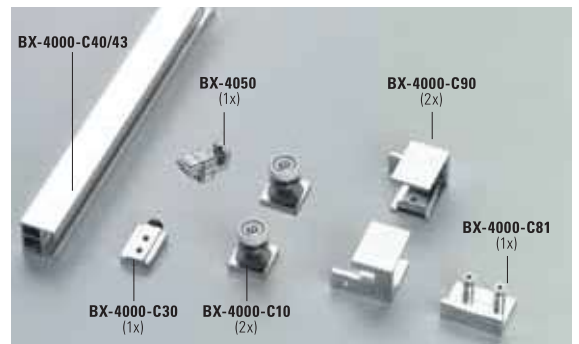
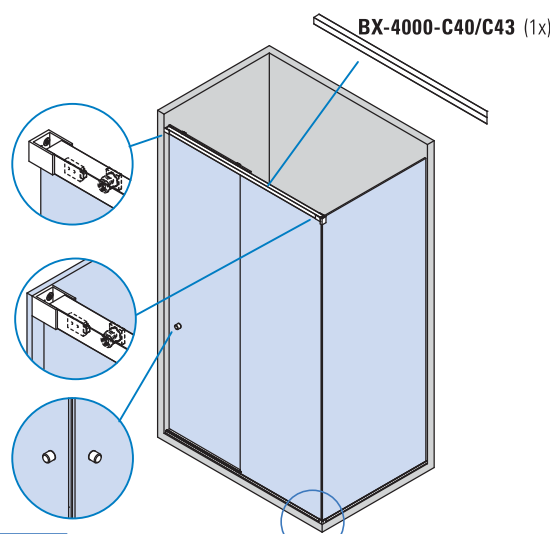

CARATTERISTICHE COMPONENTI /  
FEATURES COMPONENTS /  
EIGENSCHAFTEN EINZELTEILE ▶ 70

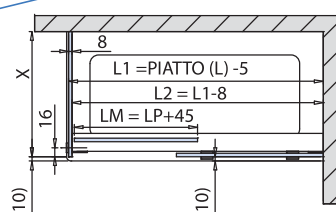
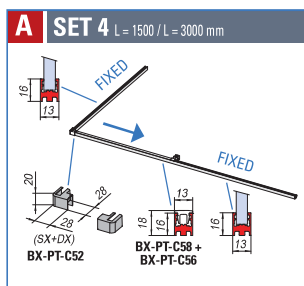

PROFILI A TERRA / FLOOR PROFILES / BODENPROFILE ▶ 106

xme512a

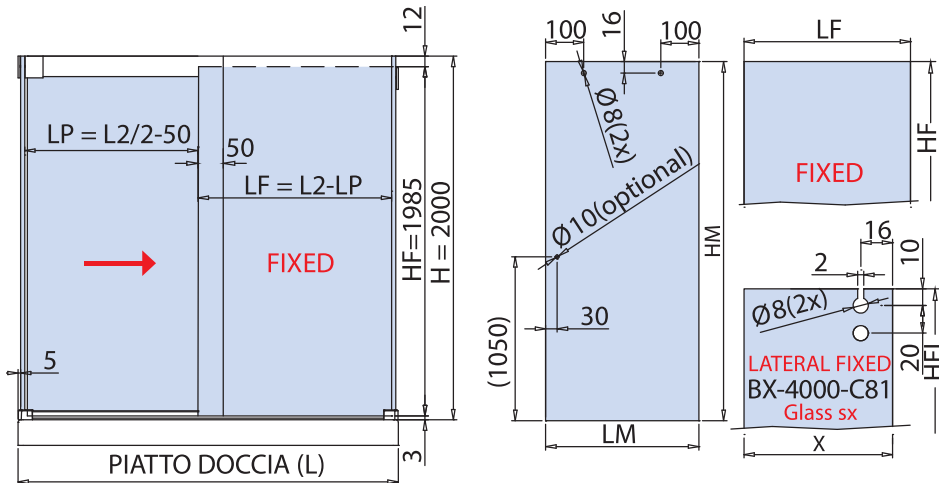
**LAVORAZIONE VETRO / GLASS PREPARATION / GLASBEARBEITUNG**

**CALCOLO VETRO / CALCULATION GLASS / GLASBERECHNUNG**

L = 1200 - 1800 mm  
 L1 = L - 5 x 2  
 L2 = L1 - 2 x 8  
 LP = L2 / 2 - 50  
 LM = LP + 45  
 LF = L2 - LP  
 X = calcolare / calculate / berechnen  
 HM = H - 10 = 1990 mm

**PROFILI A TERRA / FLOOR PROFILES / BODENPROFILE ▶ 106**

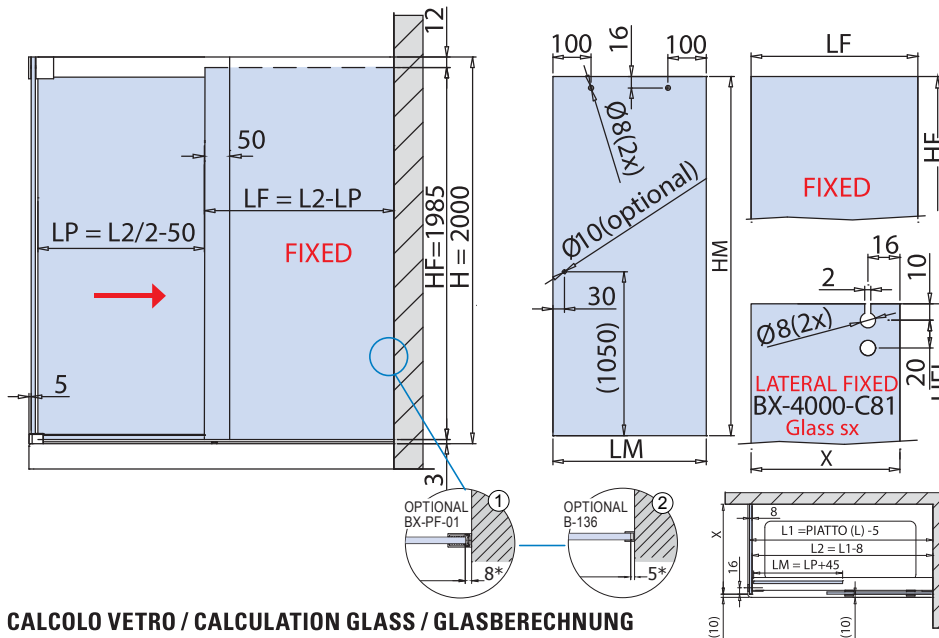
**A BX-PT-01** STANDARD HF = H - 15 = 1985 mm HFL = H - 3 xme512b



**CALCOLO VETRO / CALCULATION GLASS / GLASBERECHNUNG**

L = PIATTO DOCCIA - SHOWER TRAY - DUSCHTASSE  
 L1 = L - 5  
 L2 = L1 - 8  
 LP = L2 / 2 - 50  
 LM = LP + 45  
 LF = L2 - LP - \*① / \*② (aria variabile / clearance / Spaltmaß)  
 X = calcolare / calculate / berechnen  
 HM = H - 10 = 1990 mm

**PROFILI A TERRA / FLOOR PROFILES / BODENPROFILE ▶ 106**

**A BX-PT-01** STANDARD HF = H - 15 = 1985 mm HFL = H - 3 xme512b

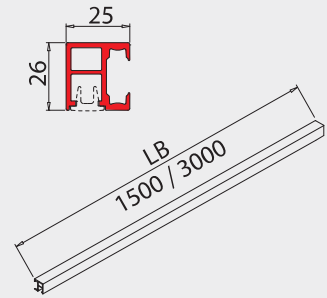
L	LP	LM	LF	HM	HF	H	HFL
Piatto Shower tray Duschtaße	Passaggio luce Clear opening width Lichte Durchgangsbreite	Larghezza vetro mobile Sliding glass width Schiebeflügel Breite	Larghezza vetro fisso Side fixed glass width Seitenteil Breite	Altezza vetro mobile Sliding glass height Schiebeflügel Höhe	Altezza vetro fisso Side fixed glass height Seitenteil Höhe	Altezza doccia Shower height Duschkabine Höhe	Altezza vetro fisso laterale Side fixed glass height Seitenteil (seitlich) Höhe

**SET 3 / SET 4**  
 DA TAGLIARE / ADJUST THE LENGTH /  
 BELIEBIG KÜRZBAR ✂

- Regolazione ruota ± 2,5 mm.
- Adjustment ± 2,5 mm.
- Verstellung ± 2,5 mm.

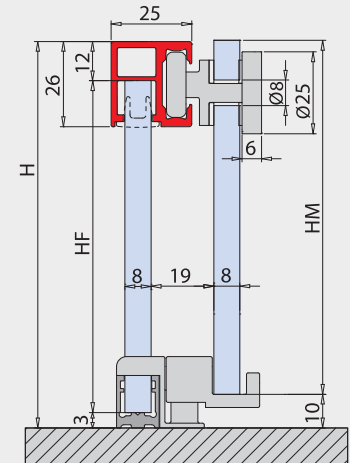

HM = H - 10  
 HF = H - 15  
 solo per / only for / nur für  
**A BX-PT-01**

**OPTIONAL**



SCORREVOLI

## BX-4000 LINEA 30 SET 5

L = 3000 mm

DOCCIA A U / U SHOWER / U DUSCHE

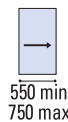
MY METALGLAS



Fin. / Fin. / Oberf.

CR	NO
Cromo lucido	Nero opaco
Polished chrome	Matt black
Chrom glänzend	Matt schwarz

### COMPONENTI / COMPONENTS / EINZELTEILE

BX-4000-C30 (2x)

BX-4000-C10 (2x)

BX-4000-C90 (2x)

OPTIONAL

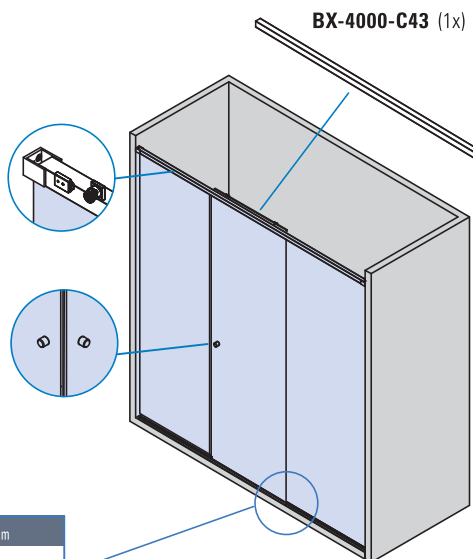

CARATTERISTICHE COMPONENTI /  
FEATURES COMPONENTS /  
EIGENSCHAFTEN EINZELTEILE ▶ 70

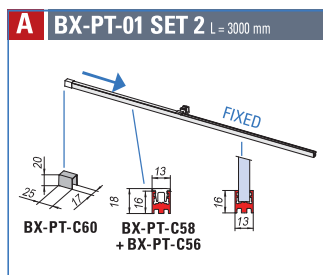

PROFILI A TERRA INCLUSI / FLOOR PROFILES INCLUDED / BODENPROFILE INKL. ▶ 106

xme512d

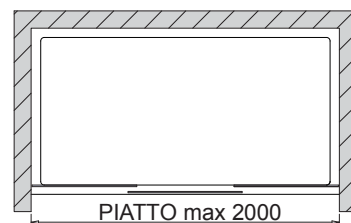

## BX-4000 LINEA 30 SET 6

L = 3000 mm

DOCCIA CON SPALLA IN VETRO / CORNER SHOWER WITH 2 FIXED PANEL  
ECKDUSCHE MIT 2 FESTSTEHENDEN GLASTAFELN

MY METALGLAS



Fin. / Fin. / Oberf.

CR	NO
Cromo lucido	Nero opaco
Polished chrome	Matt black
Chrom glänzend	Matt schwarz

### COMPONENTI / COMPONENTS / EINZELTEILE

BX-4000-C30 (4x)

BX-4000-C10 (4x)

BX-4000-C90 (2x)

OPTIONAL

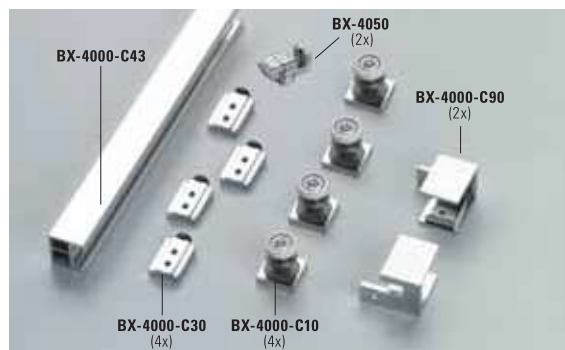
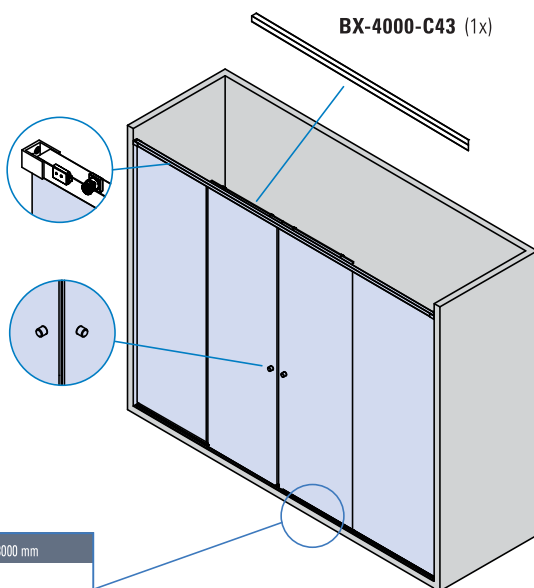

CARATTERISTICHE COMPONENTI /  
FEATURES COMPONENTS /  
EIGENSCHAFTEN EINZELTEILE ▶ 70

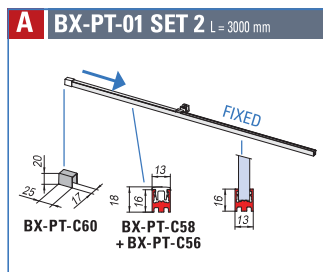

PROFILI A TERRA INCLUSI / FLOOR PROFILES INCLUDED / BODENPROFILE INKL. ▶ 106

xme512e

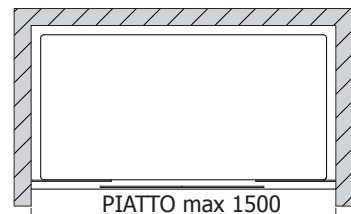

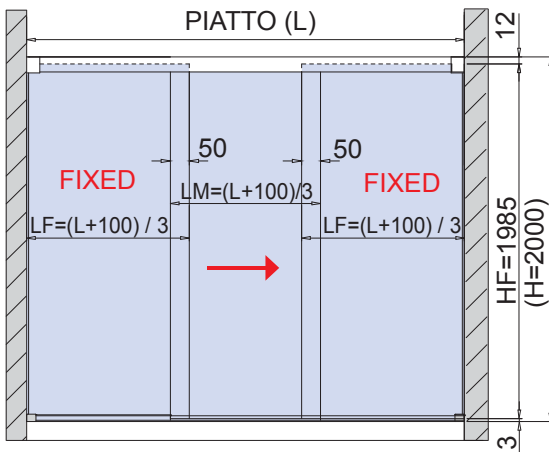
**LAVORAZIONE VETRO / GLASS PREPARATION / GLASBEARBEITUNG**

**CALCOLO VETRO / CALCULATION GLASS / GLASBERECHNUNG**

$L = \max 2000 \text{ mm}$   
 $LM = (L + 100) / 3$   
 $LF = (L + 100) / 3$   
 LF = (aria variabile / clearance / Spaltmaß)  
 $HM = H - 10 = 1990 \text{ mm}$

**PROFILI A TERRA / FLOOR PROFILES / BODENPROFILE ▶ 106**

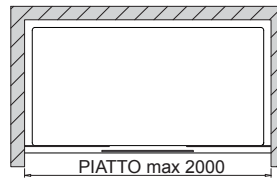
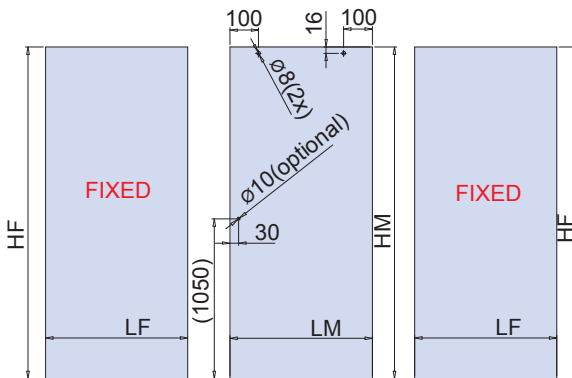
**▲ BX-PT-C58**  
 STANDARD  $HF = H - 15 = 1985 \text{ mm}$

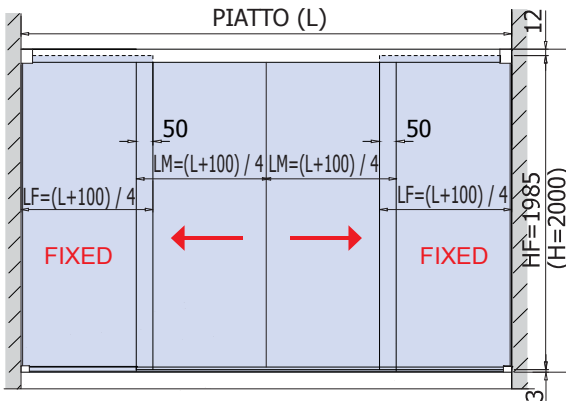

xme512d

**CALCOLO VETRO / CALCULATION GLASS / GLASBERECHNUNG**

$L = \max 1500 \text{ mm}$   
 $LM = (L + 100) / 4$   
 $LF = (L + 100) / 4$   
 LF = (aria variabile / clearance / Spaltmaß)  
 $HM = H - 10 = 1990 \text{ mm}$

**PROFILI A TERRA / FLOOR PROFILES / BODENPROFILE ▶ 106**

**▲ BX-PT-C58**  
 STANDARD  $HF = H - 15 = 1985 \text{ mm}$

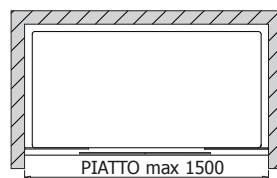
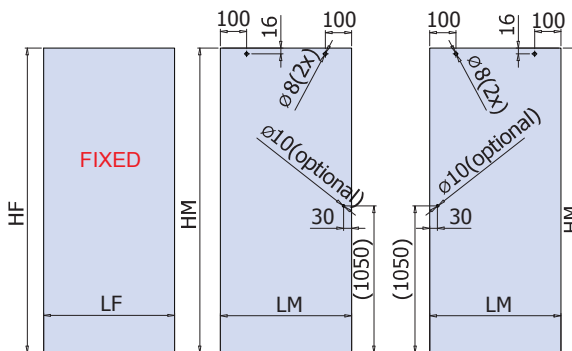

xme512e

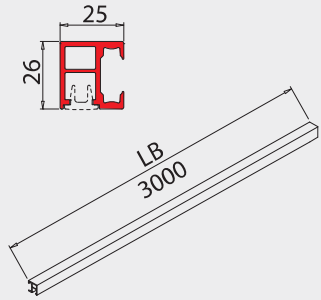
**SET 5 / SET 6**
**DA TAGLIARE / ADJUST THE LENGTH / BELIEBIG KÜRZBAR ✂**

- Regolazione ruota  $\pm 2,5 \text{ mm}$ .
- Adjustment  $\pm 2,5 \text{ mm}$ .
- Verstellung  $\pm 2,5 \text{ mm}$ .

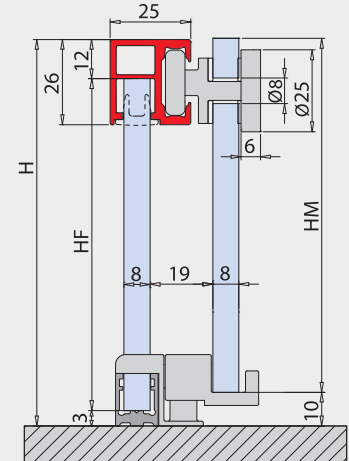

$HM = H - 10$   
 $HF = H - 15$   
 solo per / only for / nur für  
**▲ BX-PT-01**

**OPTIONAL**

L	LP	LM	LF	HM	HF	H	HFL
Piatto	Passaggio luce	Larghezza vetro mobile	Larghezza vetro fisso	Altezza vetro mobile	Altezza vetro fisso	Altezza doccia	Altezza vetro fisso laterale
Duschtasse	Lichte Durchgangsbreite	Schiebeflügel Breite	Seitenteil Breite	Schiebeflügel Höhe	Seitenteil Höhe	Duschkabine Höhe	Seitenteil (seitlich) Höhe

# BX-4000 LINEA 30

## COMPONENTI / COMPONENTS / EINZELTEILE

SCORREVOLI



### BX-4000-C43/BX-4000-C40

- Binario con veletta BX-4001 inclusa
- Track profile with cover profile BX-4001 included
- Laufschiene mit Sichtschutzprofil BX-4001 enthalten

CR - NO - OR

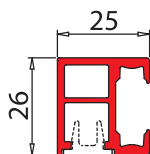

Cod.	Fin. / Fin. / Oberf.
BX-4000-C43-1500 mm	CR / NO / OR
BX-4000-C43-3000 mm	CR / NO / OR
BX-4000-C40-1000 x 1000 mm (2 pcs 45°)	CR / NO / OR



xme216



### BX-4000-C10

- Ruota
- Roller
- Laufrolle

CR - NO - OR

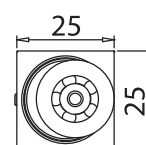
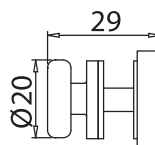
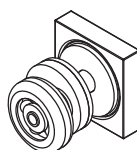

xme512c



### BX-4000-C90 DX

- Attacco a parete destro per binario
- Right wall connector for track profile
- Wandhalter rechts für Laufschiene

CR - NO - OR

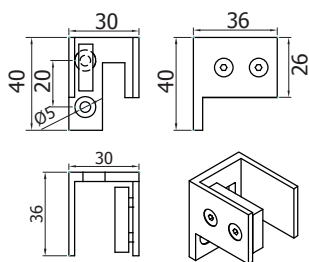

xme512c



### BX-4000-C90 SX

- Attacco a parete sinistro per binario
- Left wall connector for track profile
- Wandhalter links für Laufschiene

CR - NO - OR

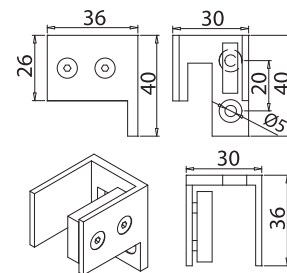

xme512c



BX-4000-C81

### BX-4000-C90

- Non incluso
- Not included
- Nicht enthalten

### BX-4000-C81

- Piastrina attacco a vetro binario
- Plate glass connector rail
- Platte Glashalter Laufschiene

CR - NO - OR

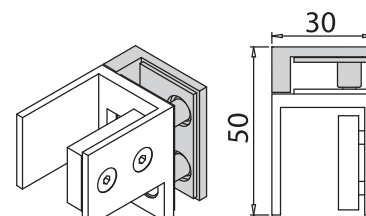
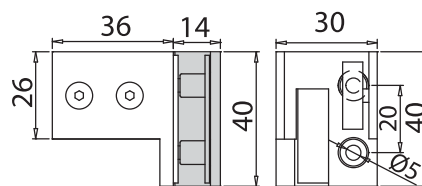

xfb-065

**BX-4000-C30**

- Stopper
- CR - NO - OR

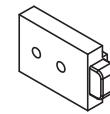
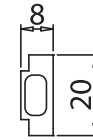
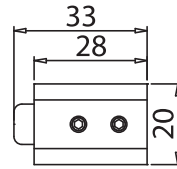
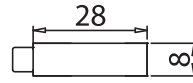

xme512c

**BX-4000-C20**

- Connettore ad angolo per binario set 1
- Corner connector for track profile set 1
- Winkelverbinder Laufschiene set 1
- CR - NO - OR

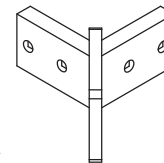
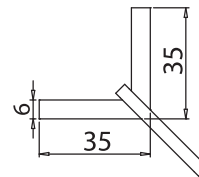
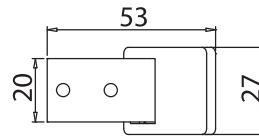

xme512c

**BX-4050**

- Guida vetro scorrevole BX-4050 per applicazione con profilo a terra BX-PT-C58 con sistema di sgancio della porta per facilitare la pulizia.
- Floor guide sliding panel BX-4050 for installation with floor profile BX-PT-C58 with quick release door function for easy cleaning.
- Schiebetür Bodenführung BX-4050 für Montage mit Bodenprofil BX-PT-C58 mit auslosbarem System um das Reinigen zu erleichtern.

CR - NO - OR

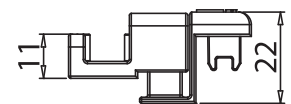
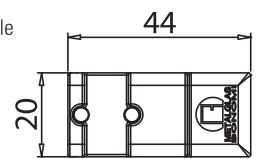

xme512c

**BX-PT-C58**

- Profilo per fissaggio a terra o laterale
- Profile for floor and side installation
- Profil Boden- Wandmontage

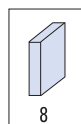
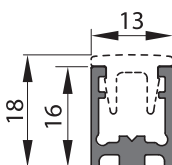

Cod.	Fin. / Fin. / Oberf.
BX-PT-C58-1500 mm	CR / NO / OR
BX-PT-C58-3000 mm	CR / NO / OR

**BX-PT-C56**

- Coperchio per profilo a terra per tratto entrata doccia
- Cover profile for floor profile, shower entry.
- Profilabdeckung Bodenprofil Duscheinstieg

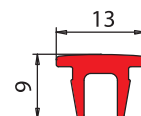

Cod.	Fin. / Fin. / Oberf.
BX-PT-C56-1500 mm	CR / NO / OR
BX-PT-C56-3000 mm	CR / NO / OR



SCORREVOLI



# BX-6050 PURA

## VEDRAI L'USUALE CON OCCHI DIVERSI

Con Eterea ci siamo accorti che per noi innovare è consuetudine. Volevamo semplificare un prodotto classico per renderlo il più possibile minimale, bello ed accattivante, ed alla fine abbiamo fatto "scompare tutto".

PER IL SUO DESIGN E PER L'INNOVAZIONE CHE LA CONTRADDISTINGUE ETEREA SI CANDIDA AD ESSERE LA MIGLIORE SUL MERCATO.

### YOU WILL SEE THE USUAL WITH DIFFERENT EYES

With Eterea we realised that it is customary for us to innovate. We set out to simplify a classic product to make it as minimal, beautiful and as alluring as possible, and ultimately we made "everything disappear". Due to its design and the innovation that distinguishes it, Eterea boasts it is the best on the market.

### SIE WERDEN DAS NORMALE MIT ANDEREN AUGEN BETRACHTEN

Mit Eterea haben wir bemerkt, dass Innovation für uns üblich ist. Wir wollten ein klassisches Produkt vereinfachen, um es möglichst minimal zu gestalten, schön und attraktiv, und schließlich haben wir „alles verschwinden lassen“. Aufgrund des herausragenden Designs und der Innovation konkurriert Eterea, um die Beste auf dem Markt zu werden.



## BOX DOCCIA MODELLO TRADIZIONALE

TRADITIONAL SHOWER ENCLOSURE MODEL  
TRADITIONELLES DUSCHKABINEMODELL

INVISIBILE IN  
PURA  
BX-6050

INVISIBLE IN PURA BX-6050  
UNSICHTBAR PURA BX-6050



SCORREVOLI

NEW

### PLUS

- DESIGN "TECNICO" CON RUOTE A VISTA
- NESSUNO STOPPER A VISTA
- SISTEMA ANTISOLLEVAMENTO DI SICUREZZA INVISIBILE

- "Technical" design, visible wheels
- No visible stopper
- Invisible safety anti-lift system

- "Technisches" Design mit sichtbaren Räder
- Kein sichtbarer Stopper
- Unsichtbare Sicherung gegen das Hochschieben

## BX-6050 PURA

- Profilo completamente libero e semplificazione della pulizia, quindi eliminazione totale di depositi e residui dovuti al normale utilizzo. Costruita in alluminio è disponibile nelle finiture cromo lucido e effetto inox.
- A completely free profile also means simplification of cleaning, therefore complete elimination of deposits and residues due to normal use. Made of aluminium, it is available in polished chrome and inox effect.
- Ein vollständig freies Profil bedeutet auch vereinfachte Reinigung, daher werden Ablagerungen und Rückstände durch normalen Gebrauch komplett beseitigt. Hergestellt aus Aluminium und ist mit Oberflächen in Chrom glänzend und Edelstahl ähnlich.



SCORREVOLI





SET 1

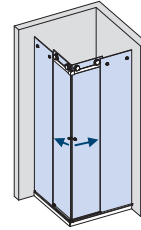

SET 2

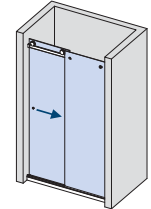

SET 3

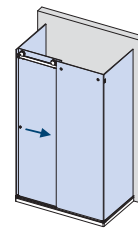

SET 4

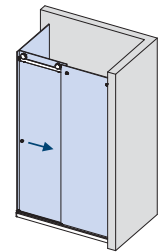

SET 5

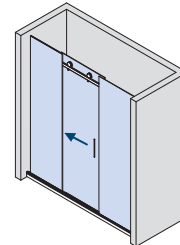

SCORREVOLI

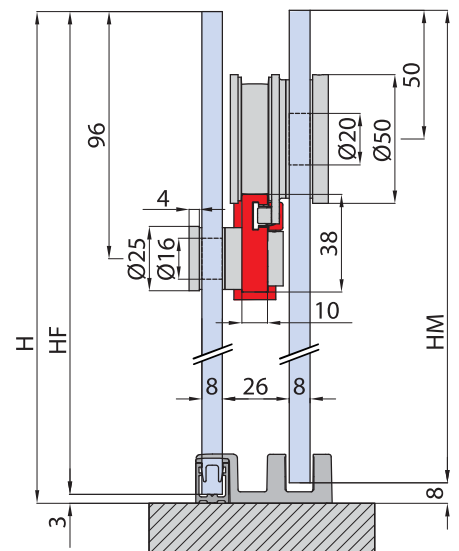

# BX-6050 SET 1

L = 1000 x 1000mm

DOCCIA IN ANGOLO / CORNER SHOWER / ECKDUSCHE

MY METALGLAS

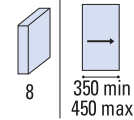

Fin. / Fin. / Oberf.

CR	IX	NO
Cromo lucido	Effetto inox satinato	Nero opaco
Polished chrome	Inox effect	Matt black
Chrom glänzend	Inox effekt	Schwarz matt

## COMPONENTI / COMPONENTS / EINZELTEILE

- BX-6050-C90 (2x)
- BX-6050-C70 (4x)
- BX-6050-C30 (2x)
- BX-6050-C10 (4x)
- BX-6050-C20 (1x)
- OPTIONAL

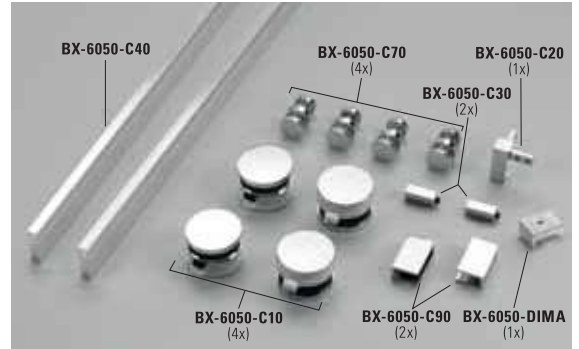
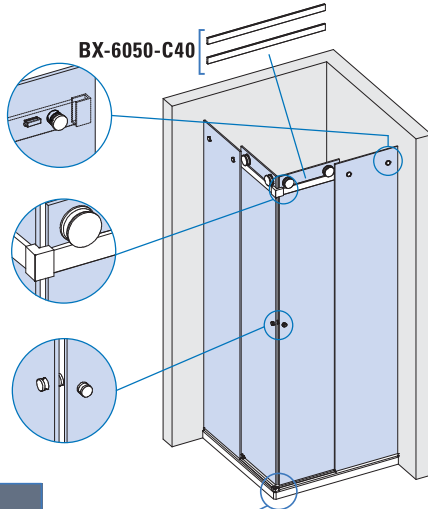

CARATTERISTICHE COMPONENTI / FEATURES COMPONENTS / EIGENSCHAFTEN EINZELTEILE ▶ 80

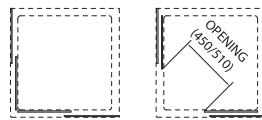
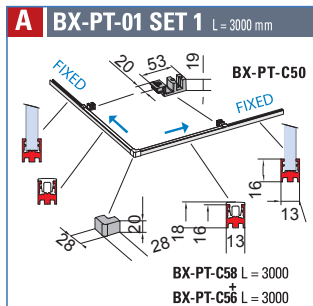

PROFILI A TERRA / FLOOR PROFILES / BODENPROFILE ▶ 106

xme627a

# BX-6050 SET 2

L = 1500mm / L = 3000mm

DOCCIA IN NICCHIA / NICHE SHOWER / NISCHENDUSCHE

MY METALGLAS

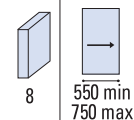

Fin. / Fin. / Oberf.

CR	IX	NO
Cromo lucido	Effetto inox satinato	Nero opaco
Polished chrome	Inox effect	Matt black
Chrom glänzend	Inox effekt	Schwarz matt

## COMPONENTI / COMPONENTS / EINZELTEILE

- BX-6050-C10 (2x)
- BX-6050-C90 (2x)
- BX-6050-C70 (2x)
- BX-6050-C30 (1x)
- OPTIONAL

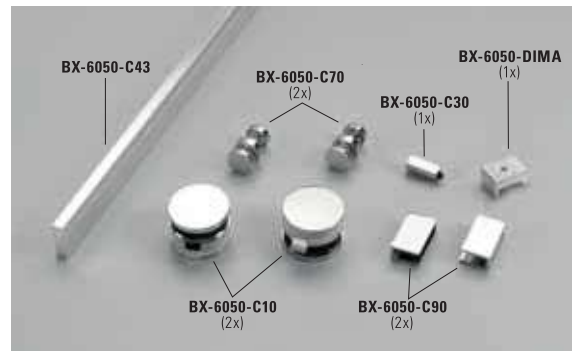
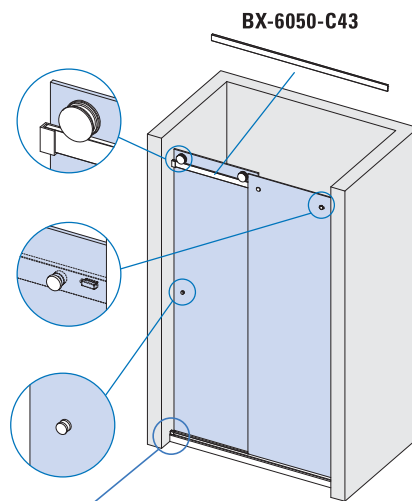

CARATTERISTICHE COMPONENTI / FEATURES COMPONENTS / EIGENSCHAFTEN EINZELTEILE ▶ 80

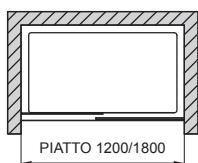
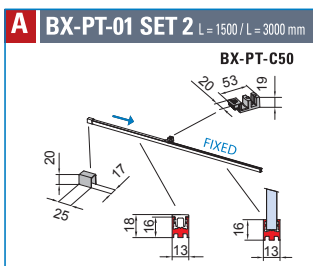

PROFILI A TERRA / FLOOR PROFILES / BODENPROFILE ▶ 106

xme627a

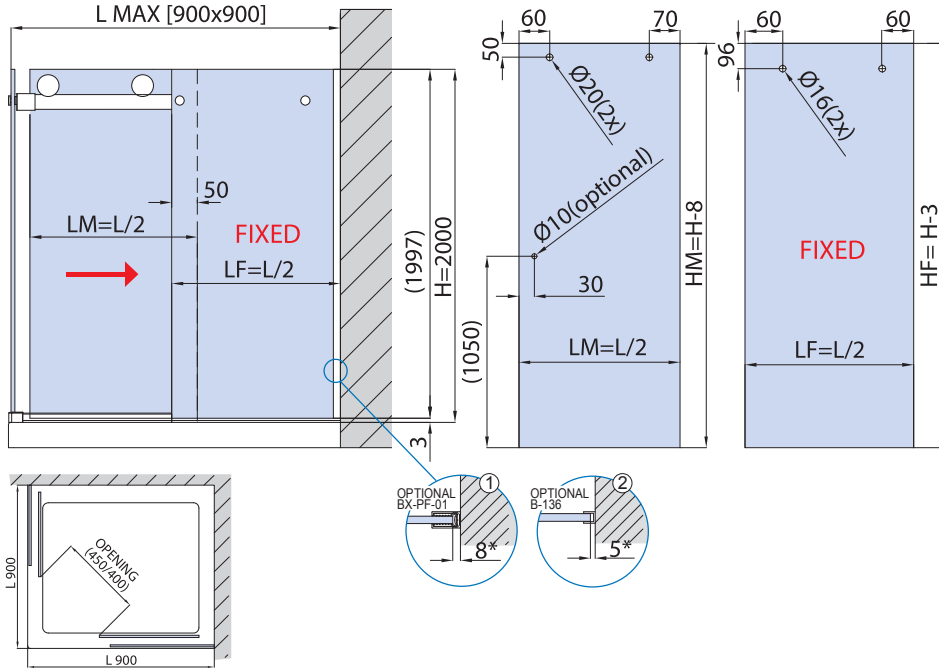
**LAVORAZIONE VETRO / GLASS PREPARATION / GLASBEARBEITUNG**

**CALCOLO VETRO / CALCULATION GLASS / GLASBERECHNUNG**

PIATTO - SHOWER TRAY - DUSCHTASSE (L) = (900x900) mm

Vetro Mobile Larghezza (LM) = L / 2

Vetro Fisso Larghezza (LF) = [(L / 2)] - \* ① / \* ② (aria variabile / clearance / Spaltmaß)

Vetro Mobile Altezza (HM) = H - 8 = 1992 mm

**PROFILI A TERRA / FLOOR PROFILES / BODENPROFILE ▶ 106**
**BX-PT-01** STANDARD HF = H - 3 = 1997 mm

xme627b

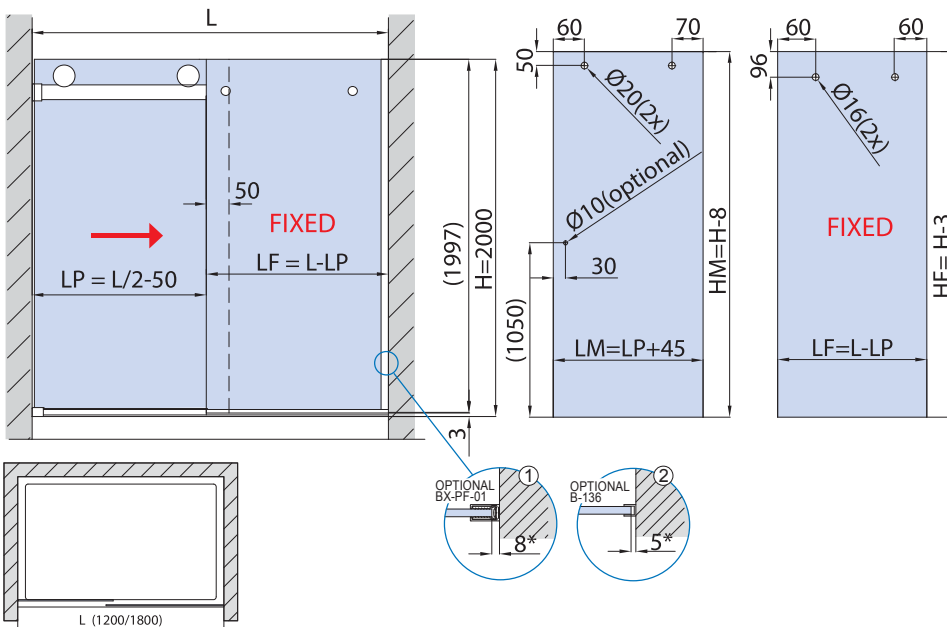
**CALCOLO VETRO / CALCULATION GLASS / GLASBERECHNUNG**

L = PIATTO - SHOWER TRAY - DUSCHTASSE

Passaggio (LP) = L / 2 - 50

Vetro Mobile Larghezza (LM) = LP + 45

Vetro Fisso Larghezza (LF) = L - LP - \* ① / \* ② (aria variabile / clearance / Spaltmaß)

Vetro Mobile Altezza (HM) = H - 8 = 1992 mm

**PROFILI A TERRA / FLOOR PROFILES / BODENPROFILE ▶ 106**
**BX-PT-01** STANDARD HF = H - 3 = 1997 mm

xme627b

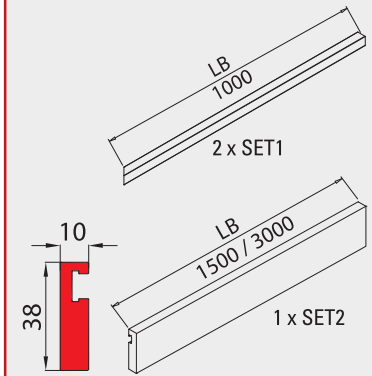
**SET 1 / SET 2**
**DA TAGLIARE / ADJUST THE LENGTH / BELIEBIG KÜRZBAR ✂**

- Regolazione ± 3 mm.
- Adjustment ± 3 mm.
- Verstellung ± 3 mm.

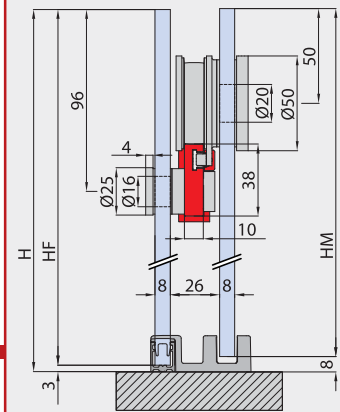
 HM = H - 8  
 HF = H - 3  
 solo per / only for / nur für **BX-PT-01**
**OPTIONAL**



L	LP	LM	LF	HM	HF	H
Piatto Shower tray Duschtaße	Passaggio luce Clear opening width Lichte Durchgangsbreite	Larghezza vetro mobile Sliding glass width Schiebeflügel Breite	Larghezza vetro fisso Side fixed glass width Seitenteil Breite	Altezza vetro mobile Sliding glass height Schiebeflügel Höhe	Altezza vetro fisso Side fixed glass height Seitenteil Höhe	Altezza doccia Shower height Duschkabine Höhe

## BX-6050 SET 3

L = 1500mm / L = 3000mm

DOCCIA A U / U SHOWER / U DUSCHE

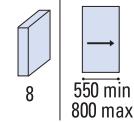
MY METALGLAS



Fin. / Fin. / Oberf.

CR	IX	NO
Cromo lucido	Effetto inox satinato	Nero opaco
Polished chrome	Inox effect	Matt black
Chrom glänzend	Inox effekt	Schwarz matt

### COMPONENTI / COMPONENTS / EINZELTEILE

**BX-6050-C10** (2x)

**BX-6050-C90** (2x)  
**BX-6050-C81** (2x)

**BX-6050-C70** (2x)

**BX-6050-C30** (1x)

**OPTIONAL**

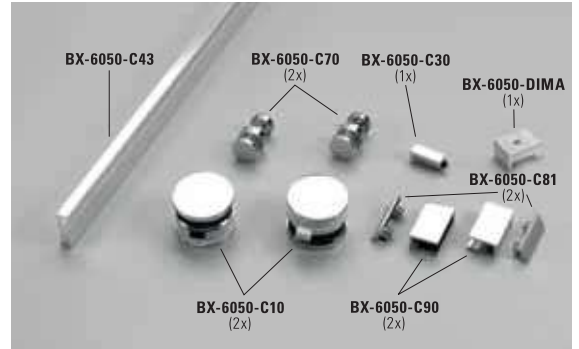
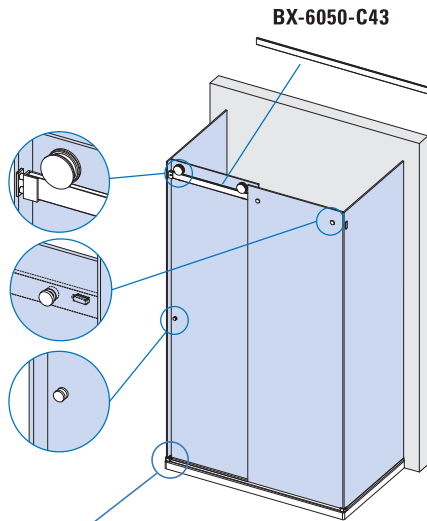

CARATTERISTICHE COMPONENTI /  
FEATURES COMPONENTS /  
EIGENSCHAFTEN EINZELTEILE ▶ 80

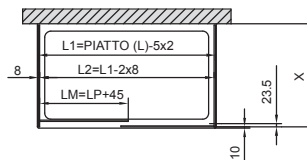
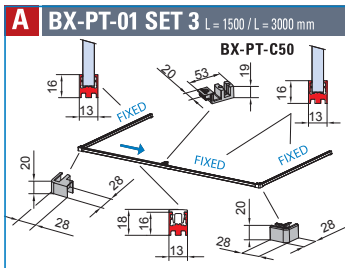

PROFILI A TERRA / FLOOR PROFILES / BODENPROFILE ▶ 106

xme627a

## BX-6050 SET 4

L = 1500mm / L = 3000mm

DOCCIA CON SPALLA IN VETRO / CORNER SHOWER WITH 2 FIXED PANELS  
ECKDUSCHE MIT 2 FESTSTEHENDEN GLASTAFELN

MY METALGLAS

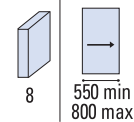

Fin. / Fin. / Oberf.

CR	IX	NO
Cromo lucido	Effetto inox satinato	Nero opaco
Polished chrome	Inox effect	Matt black
Chrom glänzend	Inox effekt	Schwarz matt

### COMPONENTI / COMPONENTS / EINZELTEILE

**BX-6050-C10** (2x)

**BX-6050-C90** (2x)  
**BX-6050-C81** (1x)

**BX-6050-C70** (2x)

**BX-6050-C30** (1x)

**OPTIONAL**

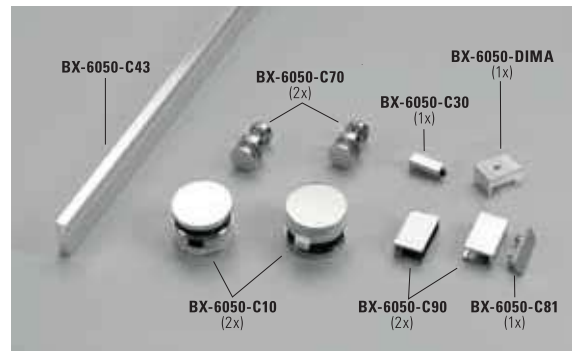
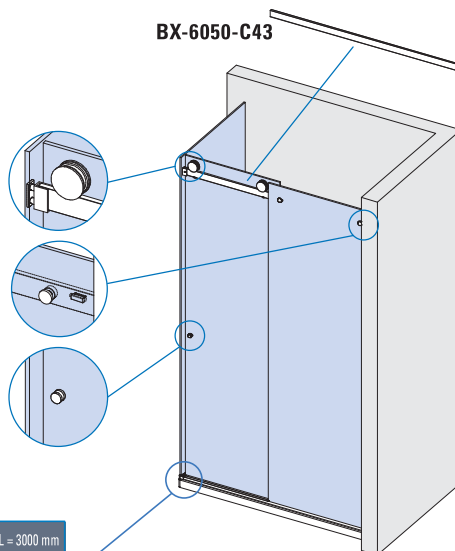

CARATTERISTICHE COMPONENTI /  
FEATURES COMPONENTS /  
EIGENSCHAFTEN EINZELTEILE ▶ 80

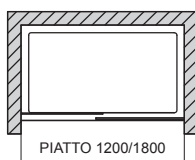
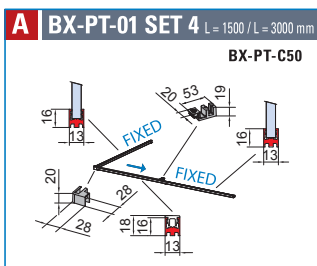

PROFILI A TERRA / FLOOR PROFILES / BODENPROFILE ▶ 106

xme627a

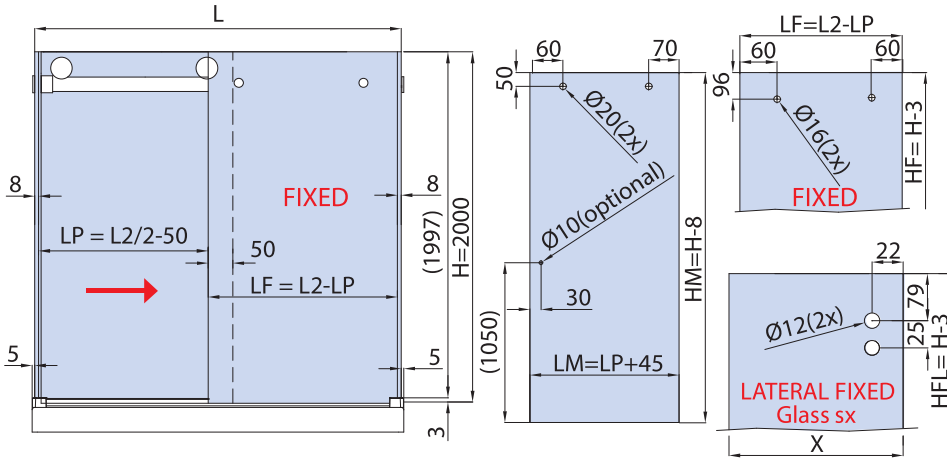
**LAVORAZIONE VETRO / GLASS PREPARATION / GLASBEARBEITUNG**

**CALCOLO VETRO / CALCULATION GLASS / GLASBERECHNUNG**

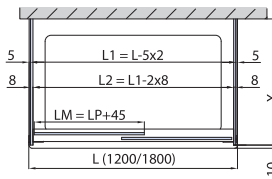
L = PIATTO - SHOWER TRAY - DUSCHTASSE  
 L1=PIATTO (L)-5x2  
 L2=L1-2x8  
 Passaggio (LP) = L2 / 2 - 50  
 Vetro Mobile Larghezza (LM) = LP + 45  
 Vetro Fisso Larghezza (LF) = L2 - LP  
 X = CALCOLARE / CALCULATE / BERECHNEN  
 Vetro Mobile Altezza (HM) = H - 8 = 1992 mm

**PROFILI A TERRA / FLOOR PROFILES / BODENPROFILE ▶ 106**

**BX-PT-01** STANDARD HF = H - 8 = 1992 mm HFL = H - 3

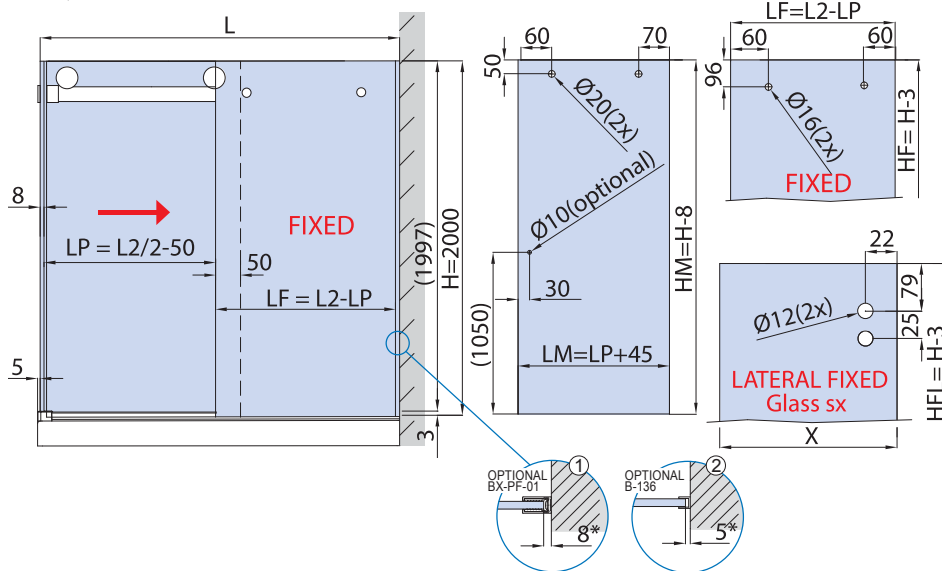
xme627c

**CALCOLO VETRO / CALCULATION GLASS / GLASBERECHNUNG**

L = PIATTO - SHOWER TRAY - DUSCHTASSE  
 L1=PIATTO (L) - 5  
 L2=L1 - 8  
 Passaggio (LP) = L2 / 2 - 50  
 Vetro Mobile Larghezza (LM) = LP + 45  
 Vetro Fisso Larghezza (LF) = L2 - LP - \* (1) / \* (2) (aria variabile / clearance / Spaltmaß)  
 X = CALCOLARE / CALCULATE / BERECHNEN  
 Vetro Mobile Altezza (HM) = H - 8 = 1992mm

**PROFILI A TERRA / FLOOR PROFILES / BODENPROFILE ▶ 106**

**BX-PT-01** STANDARD HF = H - 3 = 1997 mm

xme627c

**SET 3 / SET 4**

DA TAGLIARE / ADJUST THE LENGTH / BELIEBIG KÜRZBAR ✂

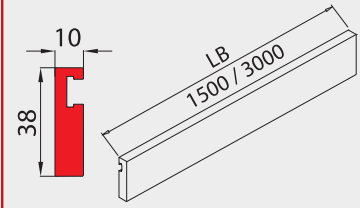

- Regolazione ± 3 mm.
- Adjustment ± 3 mm.
- Verstellung ± 3 mm.

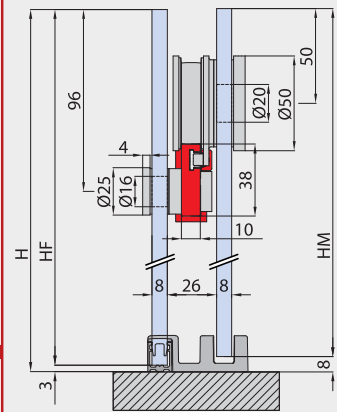

HM = H - 8  
 HF = H - 3  
 solo per / only for / nur für  
**BX-PT-01**

**OPTIONAL**

L	LP	LM	LF	HM	HF	H
Piatto Shower tray Duschtaße	Passaggio luce Clear opening width Lichte Durchgangsbreite	Larghezza vetro mobile Sliding glass width Schiebeflügel Breite	Larghezza vetro fisso Side fixed glass width Seitenteil Breite	Altezza vetro mobile Sliding glass height Schiebeflügel Höhe	Altezza vetro fisso Side fixed glass height Seitenteil Höhe	Altezza doccia Shower height Duschkabine Höhe

## BX-6050

### COMPONENTI / COMPONENTS / EINZELTEILE

SCORREVOLI



#### BX-6050-C43/ BX-6050-C40

- Binario
- Track profile
- Laufschiene

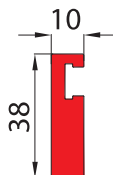

- Forature per fissaggio vetro fisso (ad opera dell'installatore con dima di foratura)
- Drilling for fixed glass by the installer (template included in Set)
- Bohrungen für Festverglasung bauseitig (Schablone im device Set enthalten)

Cod.	Fin. / Fin. / Oberf.
BX-6050-C43-1500 mm	CR / IX / NO
BX-6050-C43-3000 mm	CR / IX / NO
BX-6050-C40-1000 x 1000 mm (2 pcs)	CR / IX / NO

xme556i



#### BX-6050-C10

- Ruota con antigancio
- Roller with antijump
- Laufrolle und Aushebeschutz

CR - NS - NO

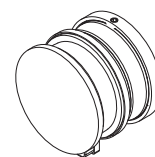
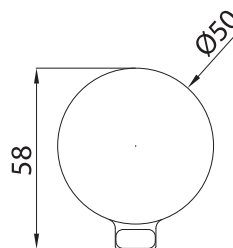
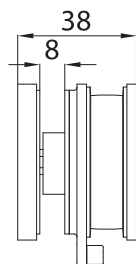

xme627d



#### BX-6050-C70

- Punto di fissaggio vetro fisso al binario
- Fixing point for fixed glass and track profile
- Punkthalter für Fixierung des Festteils auf Laufschiene

CR - NS - NO

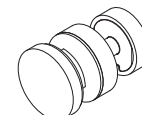
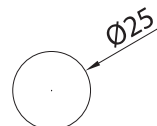
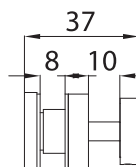

xme627d



#### BX-6050-C90 DX

- Attacco a parete destro per binario
- Right wall connector for track profile
- Wandhalter rechts für Laufschiene

CR - NS - NO

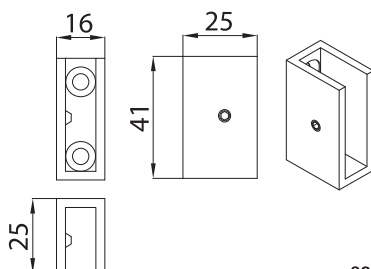

xme627d



#### BX-6050-C90 SX

- Attacco a parete sinistro per binario
- Left wall connector for track profile
- Wandhalter links für Laufschiene

CR - NS - NO

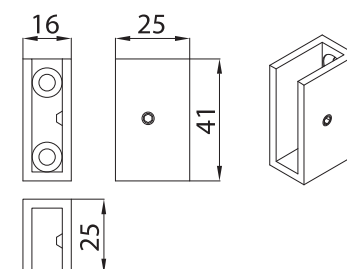

xme627d

**BX-6050-C30**

- Stopper
- CR - NS - NO

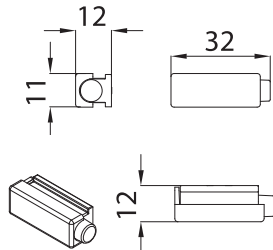

xme627d

**BX-6050-C20**

- Connettore ad angolo per binari set 1
- Corner connector for track profiles set 1
- Winkelverbinder Laufschiene set 1
- CR - NS - NO

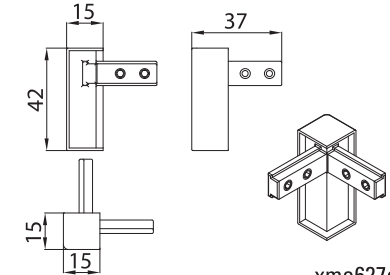

xme627d

**BX-6050-C81**

- Piastrina attacco a vetro per BX-6050-C90
- Plate glass connector for BX-6050-C90
- Platte Glashalter für BX-6050-C90
- CR - NS - NO

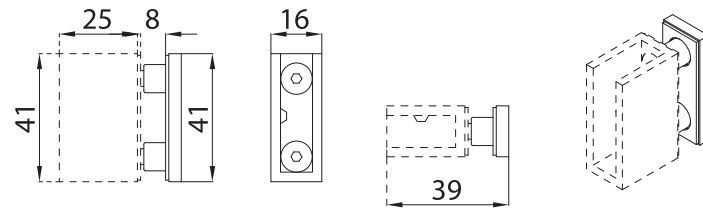

xme627d

**BX-PT-C50**

- Guida vetro scorrevole per applicazione con profilo a terra.
- Floor guide sliding panel for installation with floor profile.
- Schiebetür Bodenführung für Montage mit Bodenprofile.
- CR - NS - NO

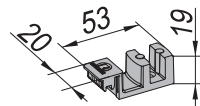
**BX-6050-DIMA**

- Dima per foratura per morsetto vetro fisso
- Template for drilling the track profile with the clamp
- Schablone für das Bohren der Laufschiene mit der Klemme

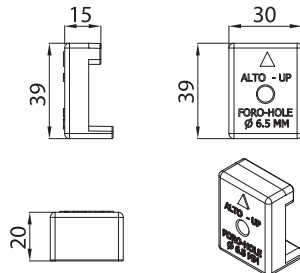

xme627d

**BX-PT-C58**

- Profilo per fissaggio a terra o laterale
- Profile for floor and side installation
- Profil Boden- Wandmontage

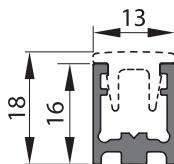

Cod.	Fin./Fin./Fin.
BX-PT-C58-1500 mm	CR / IX / NO
BX-PT-C58-3000 mm	CR / IX / NO

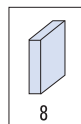
**BX-PT-C56**

- Coperchio per profilo a terra per tratto entrata doccia
- Cover profile for floor profile, shower entry.
- Profilabdeckung Bodenprofil Duscheinstieg

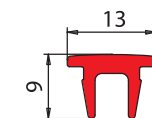

Cod.	Fin./Fin./Fin.
BX-PT-C56-1500 mm	CR / IX / NO
BX-PT-C56-3000 mm	CR / IX / NO

VISTA ESTERNA  
EXTERNAL VIEW



SCORREVOLI

VISTA INTERNA  
INTERNAL VIEW



# BX-6000 ETEREA

## VEDRAI L'USUALE CON OCCHI DIVERSI

Con Eterea ci siamo accorti che per noi innovare è consuetudine. Volevamo semplificare un prodotto classico per renderlo il più possibile minimale, bello ed accattivante, ed alla fine abbiamo fatto "scompare tutto".

PER IL SUO DESIGN E PER L'INNOVAZIONE CHE LA CONTRADDISTINGUE ETEREA SI CANDIDA AD ESSERE LA MIGLIORE SUL MERCATO.

### YOU WILL SEE THE USUAL WITH DIFFERENT EYES

With Eterea we realised that it is customary for us to innovate. We set out to simplify a classic product to make it as minimal, beautiful and as alluring as possible, and ultimately we made "everything disappear". Due to its design and the innovation that distinguishes it, Eterea boasts it is the best on the market.

### SIE WERDEN DAS NORMALE MIT ANDEREN AUGEN BETRACHTEN

Mit Eterea haben wir bemerkt, dass Innovation für uns üblich ist. Wir wollten ein klassisches Produkt vereinfachen, um es möglichst minimal zu gestalten, schön und attraktiv, und schließlich haben wir „alles verschwinden lassen“. Aufgrund des herausragenden Designs und der Innovation konkurriert Eterea, um die Beste auf dem Markt zu werden.

## BOX DOCCIA

### MODELLO TRADIZIONALE

TRADITIONAL SHOWER ENCLOSURE MODEL  
TRADITIONELLES DUSCHKABINEMODELL

INVISIBILE IN  
ETEREA  
BX-6000

INVISIBILE IN ETEREA BX-6000  
UNSICHTBAR ETEREA BX-6000



SCORREVOLI

## PLUS

- NESSUNO STOPPER A VISTA
- NESSUNA BORCHIA PER L'AGGANCO DEL VETRO FISSO A VISTA
- SISTEMA ANTISOLLEVAMENTO DI SICUREZZA INVISIBILE
- SISTEMA OPZIONALE DI CHIUSURA "SOFT-CLOSE"
- SISTEMA STANDARD DI CHIUSURA AMMORTIZZATA
- PROFILO INTERNO DOCCIA PRIVO DI ACCESSORI A VISTA

- No visible stopper
- No visible fixing point on the fixed glass panel
- Invisible safety anti-lift system
- Optional soft-close closing system.
- Standard cushioned closing system
- Shower internal profile without visible accessories

- Kein sichtbarer Stopper
- Keine sichtbare Befestigungspunkte zum fixieren des Glases
- Unsichtbares Aushebeschutzsystem
- Ein optionales Schließsystem soft-close.
- Ein gedämpftes Standard-Schließsystem
- Innenprofil der Dusche ohne sichtbares Zubehör

## **BX-6000 / BX-6020 SOFT-CLOSE**



- Profilo completamente libero e semplificazione della pulizia, quindi eliminazione totale di depositi e residui dovuti al normale utilizzo. Costruita in alluminio è disponibile nelle finiture cromo lucido e nero opaco.
- A completely free profile also means simplification of cleaning, therefore complete elimination of deposits and residues due to normal use. Made of aluminium, it is available in polished chrome and matt black finishes.
- Ein vollständig freies Profil bedeutet auch vereinfachte Reinigung, daher werden Ablagerungen und Rückstände durch normalen Gebrauch komplett beseitigt. Hergestellt aus Aluminium und ist mit Oberflächen in Chrom glänzend und matt schwarz erhältlich.



SCORREVOLI



SET 1

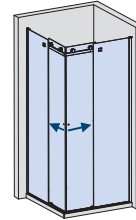

SET 2

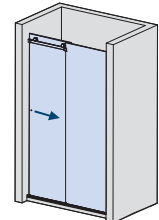

SET 3

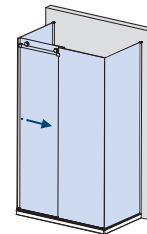

SET 4

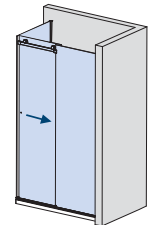

SET 5

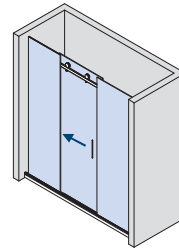

SCORREVOLI

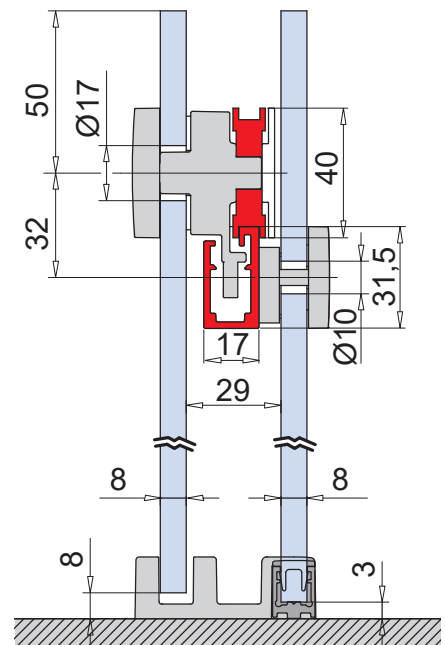

# BX-6000 SET 1

L = 1000 x 1000mm

DOCCIA IN ANGOLO / CORNER SHOWER / ECKDUSCHE

MY METALGLAS

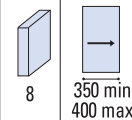

Fin. / Fin. / Oberf.

CR	NO
Cromo lucido	Nero opaco
Polished chrome	Matt black
Chrom glänzend	Matt schwarz

## COMPONENTI / COMPONENTS / EINZELTEILE

- BX-6000-C30** (2x)
- BX-6000-C10** (4x)
- BX-6000-C90** (2x)
- BX-6000-C70-2** (2x)
- BX-6000-C20** (1x)
- OPTIONAL**  
**B-136/BX-PF-01** (1x)
- OPTIONAL**

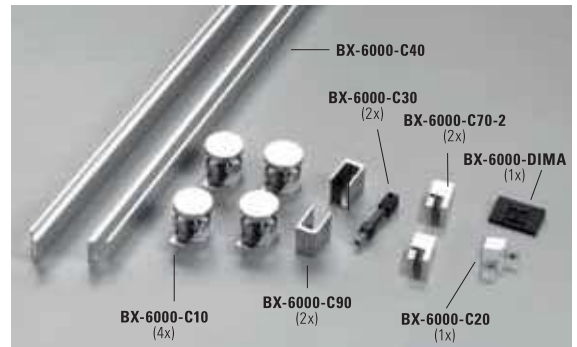
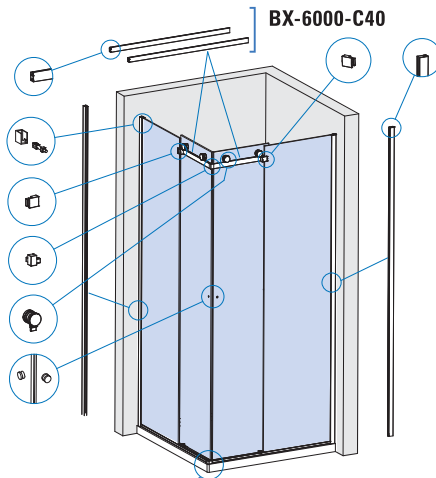

### CARATTERISTICHE COMPONENTI / FEATURES COMPONENTS / EIGENSCHAFTEN EINZELTEILE ▶ 94

- Obbligatorio fissaggio a parete tramite profili a "U" o morsetti (non inclusi)
- Necessary wall-mounting with "U" profiles or clamps (not included)
- Verbindliche Befestigung an der Wand mit „U“-Profilen oder Wandhaltern (nicht inbegriffen)

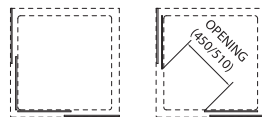
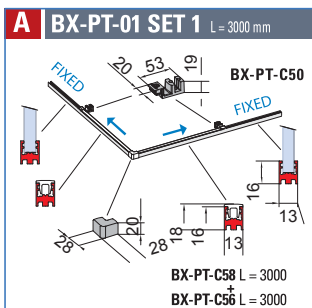

### PROFILI A TERRA / FLOOR PROFILES / BODENPROFILE ▶ 106

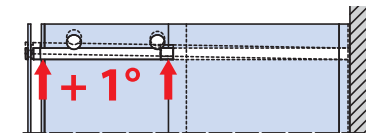

# BX-6020 SOFT-CLOSE SET 1



L = 1000 x 1000mm

DOCCIA IN ANGOLO / CORNER SHOWER / ECKDUSCHE

MY METALGLAS

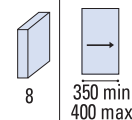

Fin. / Fin. / Oberf.

CR	NO
Cromo lucido	Nero opaco
Polished chrome	Matt black
Chrom glänzend	Matt schwarz

## COMPONENTI / COMPONENTS / EINZELTEILE

- BX-6000-SOFT-CLOSE** (2x)
- BX-6000-C10** (2x)
- BX-6000-C12** (2x)
- BX-6000-C90** (2x)
- BX-6000-C70-1** (2x)
- BX-6000-C20** (1x)
- OPTIONAL**  
**B-136/BX-PF-01** (1x)
- OPTIONAL**

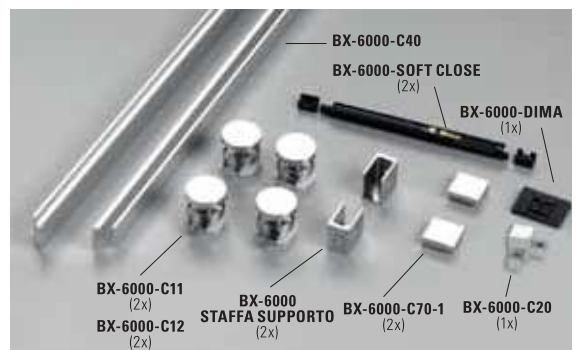
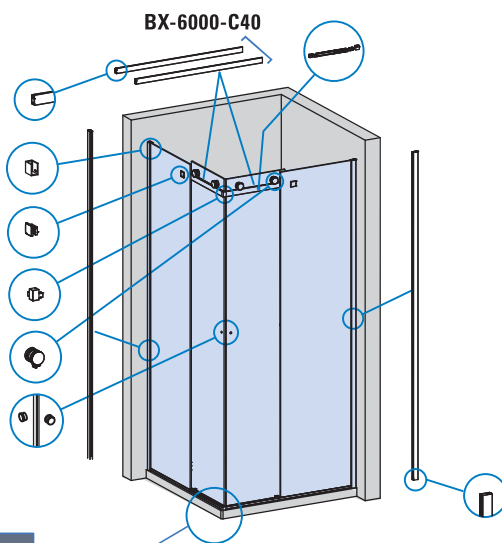

### CARATTERISTICHE COMPONENTI / FEATURES COMPONENTS / EIGENSCHAFTEN EINZELTEILE ▶ 94

- Obbligatorio fissaggio a parete tramite profili a "U" o morsetti (non inclusi)
- Necessary wall-mounting with "U" profiles or clamps (not included)
- Verbindliche Befestigung an der Wand mit „U“-Profilen oder Wandhaltern (nicht inbegriffen)

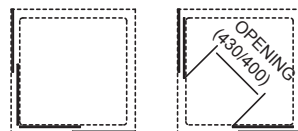
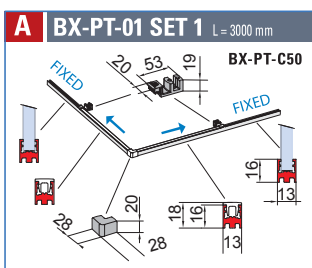

### PROFILI A TERRA / FLOOR PROFILES / BODENPROFILE ▶ 106

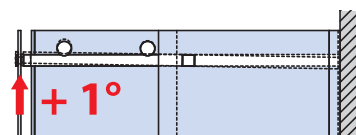

## LAVORAZIONE VETRO / GLASS PREPARATION / GLASBEARBEITUNG

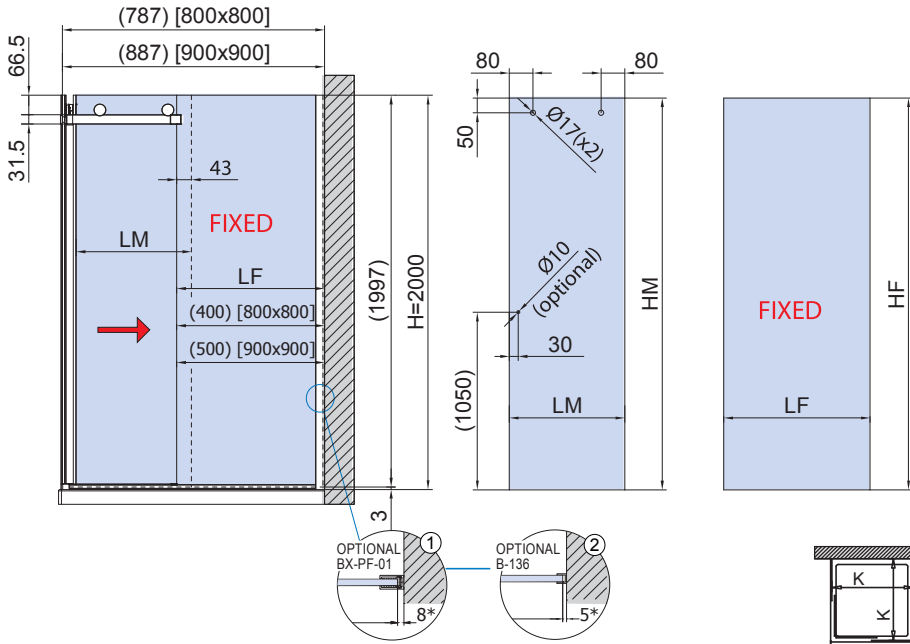

### CALCOLO VETRO / CALCULATION GLASS / GLASBERECHNUNG

PIATTO - SHOWER TRAY - DUSCHASSE (L) = 800x800 (900x900) mm

Vetro Mobile Larghezza (LM) = L / 2

Vetro Fisso Larghezza (LF) = [(L / 2)] - \* ① / \* ② (aria variabile / clearance / Spaltmaß)

Vetro Mobile Altezza (HM) = H - 8 = 1992 mm

### PROFILI A TERRA / FLOOR PROFILES / BODENPROFILE ▶ 106

**BX-PT-01** STANDARD HF = H - 3 = 1997 mm

xme556a

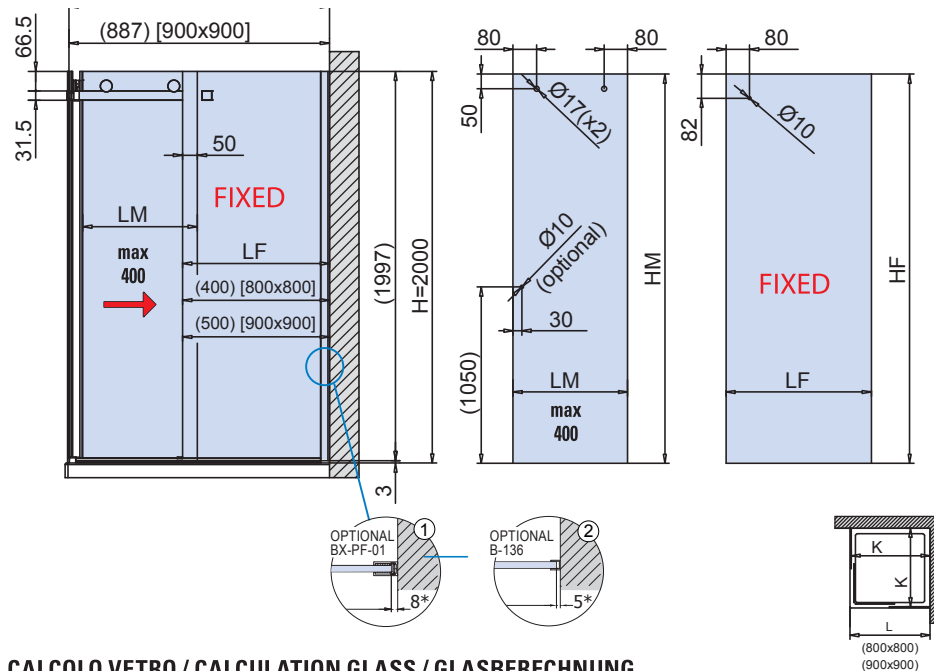

### CALCOLO VETRO / CALCULATION GLASS / GLASBERECHNUNG

PIATTO - SHOWER TRAY - DUSCHASSE (L) = 800x800 (900x900) mm

Vetro Mobile Larghezza (LM) = L / 2

Vetro Fisso Larghezza (LF) = [(L / 2)] - \* ① / \* ② (aria variabile / clearance / Spaltmaß)

Vetro Mobile Altezza (HM) = H - 8 = 1992 mm

### PROFILI A TERRA / FLOOR PROFILES / BODENPROFILE ▶ 106

**BX-PT-01** STANDARD HF = H - 3 = 1997 mm

xme556b

### SET 1

DA TAGLIARE / ADJUST THE LENGTH / BELIEBIG KÜRZBAR ✂

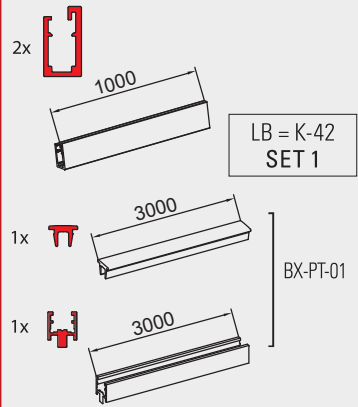

- Regolazione ± 2 mm.
- Adjustment ± 2 mm.
- Verstellung ± 2 mm.

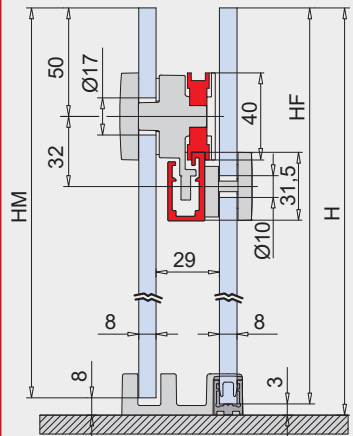

HM = H - 8  
 HF = H - 3  
 solo per / only for / nur für  
**BX-PT-01**

### OPTIONAL



L	LP	LM	LF	HM	HF	H
Piatto Shower tray Duschasse	Passaggio luce Clear opening width Lichte Durchgangsbreite	Larghezza vetro mobile Sliding glass width Schiebeflügel Breite	Larghezza vetro fisso Side fixed glass width Seitenteil Breite	Altezza vetro mobile Sliding glass height Schiebeflügel Höhe	Altezza vetro fisso Side fixed glass height Seitenteil Höhe	Altezza doccia Shower height Duschkabine Höhe

# BX-6000 SET 2 DX / BX-6000 SET 2 SX

MY METALGLAS

L = 1500mm / L = 3000mm

DOCCIA IN NICCHIA / NICHE SHOWER / NISCHENDUSCHE

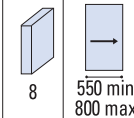

Fin. / Fin. / Oberf.

CR	NO
Cromo lucido	Nero opaco
Polished chrome	Matt black
Chrom glänzend	Matt schwarz

## COMPONENTI / COMPONENTS / EINZELTEILE

- BX-6000-C30** (1x)
- BX-6000-C10** (2x)
- BX-6000-C90** (2x)
- BX-6000-C70-2** (1x)
- OPTIONAL**  
B-136/BX-PF-01 (1x)
- OPTIONAL**

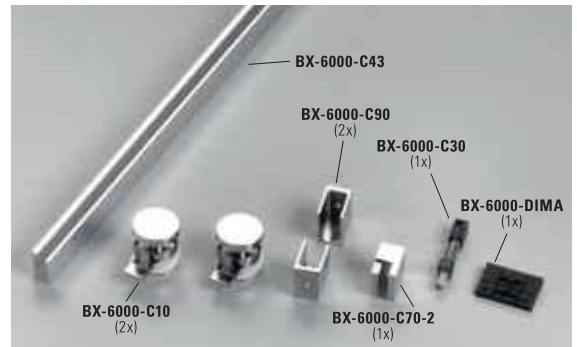
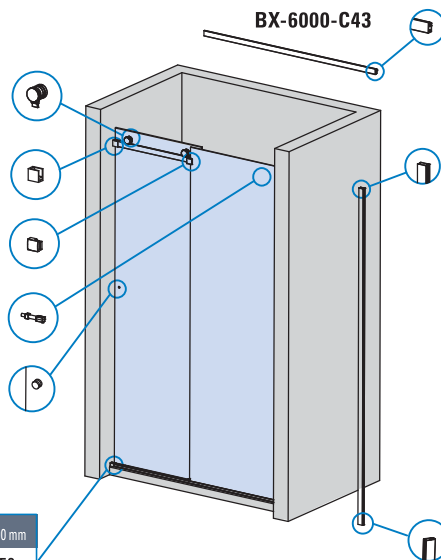

CARATTERISTICHE COMPONENTI /  
FEATURES COMPONENTS /  
EIGENSCHAFTEN EINZELTEILE ▶ 94

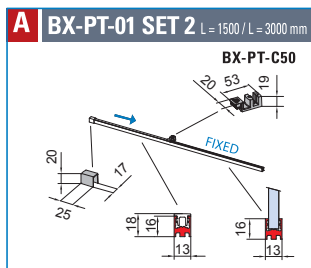

PROFILI A TERRA / FLOOR PROFILES / BODENPROFILE ▶ 106

xme556c

# BX-6020 SOFT-CLOSE SET 2



MY METALGLAS

L = 1500mm / L = 3000mm

DOCCIA IN NICCHIA / NICHE SHOWER / NISCHENDUSCHE

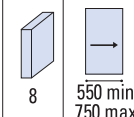

Fin. / Fin. / Oberf.

CR	NO
Cromo lucido	Nero opaco
Polished chrome	Matt black
Chrom glänzend	Matt schwarz

## COMPONENTI / COMPONENTS / EINZELTEILE

- BX-6000-SOFT-CLOSE** (1x)
- BX-6000-C11** (1x)
- BX-6000-C12** (1x)
- BX-6000-C90** (2x)
- BX-6000-C70-1** (1x)
- OPTIONAL**  
B-136/BX-PF-01 (1x)
- OPTIONAL**

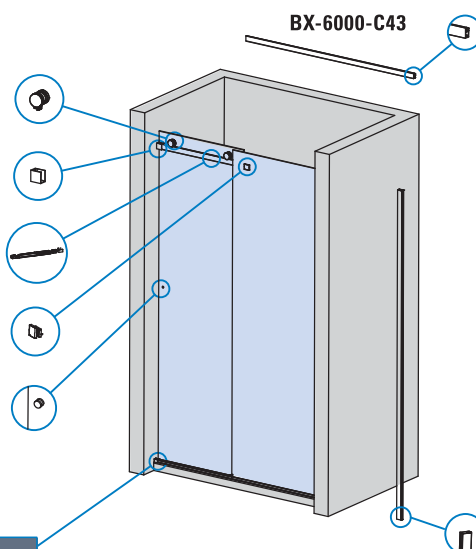

CARATTERISTICHE COMPONENTI /  
FEATURES COMPONENTS /  
EIGENSCHAFTEN EINZELTEILE ▶ 94

- Obbligatorio fissaggio a parete tramite profili a "U" o morsetti (non inclusi)
- Necessary wall-mounting with "U" profiles or clamps (not included)
- Verbindliche Befestigung an der Wand mit „U“-Profilen oder Wandhaltern (nicht inbegriffen)

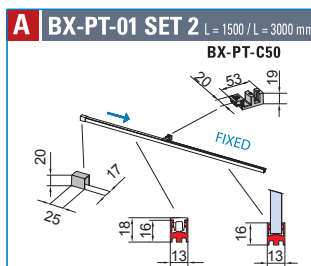

PROFILI A TERRA / FLOOR PROFILES / BODENPROFILE ▶ 106

xme556d

SCORREVOLI



# BX-6000 SET 3 DX / BX-6000 SET 3 SX

MY METALGLAS

L = 1500mm / L = 3000mm

DOCCIA A U / U SHOWER / U DUSCHE

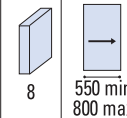

Fin. / Fin. / Oberf.

CR	NO
Cromo lucido	Nero opaco
Polished chrome	Matt black
Chrom glänzend	Matt schwarz

## COMPONENTI / COMPONENTS / EINZELTEILE

- BX-6000-C30** (1x)
- BX-6000-C10** (2x)
- BX-6000-C90** (2x)  
**BX-6000-C81** (2x)
- BX-6000-C70-2** (1x)  
**BX-6000-C70-1** (1x)
- OPTIONAL**  
**B-136/BX-PF-01** (1x)
- OPTIONAL**

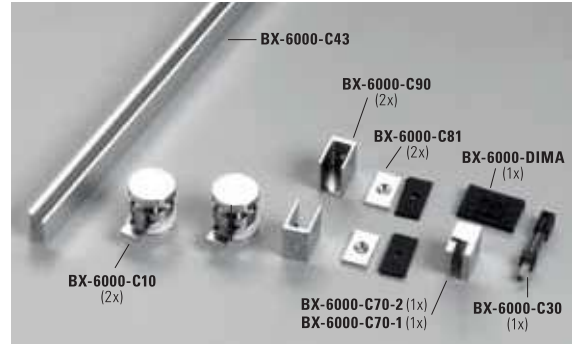
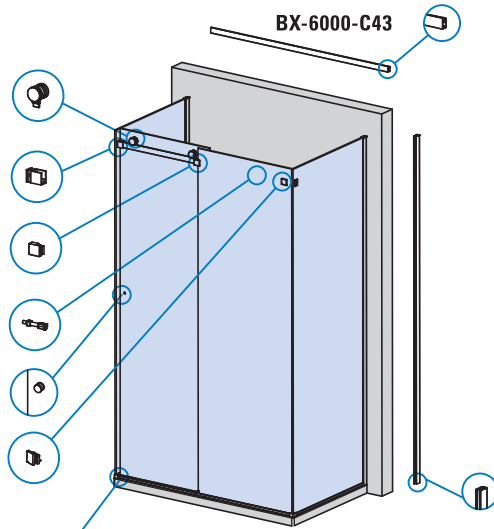

**CARATTERISTICHE COMPONENTI / FEATURES COMPONENTS / EIGENSCHAFTEN EINZELTEILE ▶ 94**



- Obbligatorio fissaggio a parete tramite profili a "U" o morsetti (non inclusi)
- Necessary wall-mounting with "U" profiles or clamps (not included)
- Verbindliche Befestigung an der Wand mit „U“-Profilen oder Wandhaltern (nicht inbegriffen)

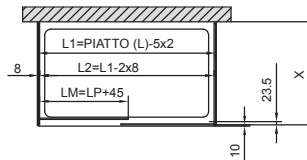
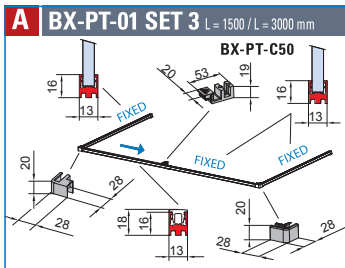

**PROFILI A TERRA / FLOOR PROFILES / BODENPROFILE ▶ 106**

xme556e

# BX-6020 SOFT-CLOSE SET 3



MY METALGLAS

L = 1500mm / L = 3000mm

DOCCIA A U / U SHOWER / U DUSCHE

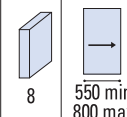

Fin. / Fin. / Oberf.

CR	NO
Cromo lucido	Nero opaco
Polished chrome	Matt black
Chrom glänzend	Matt schwarz

## COMPONENTI / COMPONENTS / EINZELTEILE

- BX-6000-SOFT-CLOSE** (1x)
- BX-6000-C11** (1x)  
**BX-6000-C12** (1x)
- BX-6000-C90** (2x)  
**BX-6000-C81** (2x)
- BX-6000-C70-1** (2x)
- OPTIONAL**  
**B-136/BX-PF-01** (2x)
- OPTIONAL**

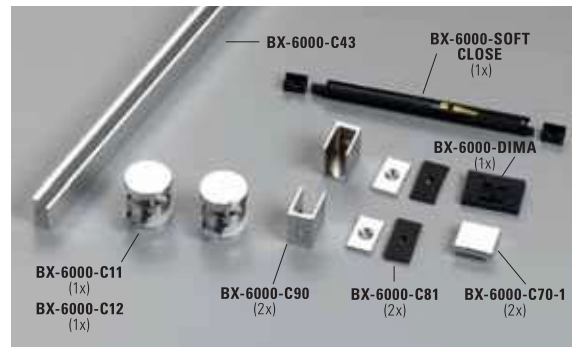
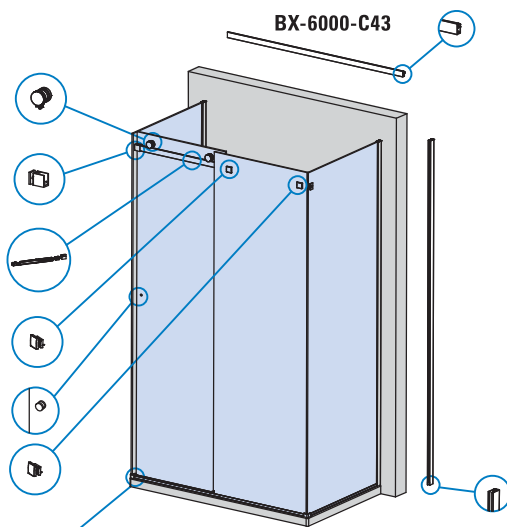

**CARATTERISTICHE COMPONENTI / FEATURES COMPONENTS / EIGENSCHAFTEN EINZELTEILE ▶ 94**

- Obbligatorio fissaggio a parete tramite profili a "U" o morsetti (non inclusi)
- Necessary wall-mounting with "U" profiles or clamps (not included)
- Verbindliche Befestigung an der Wand mit „U“-Profilen oder Wandhaltern (nicht inbegriffen)

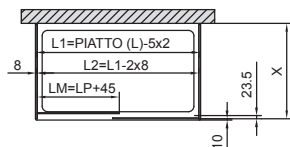
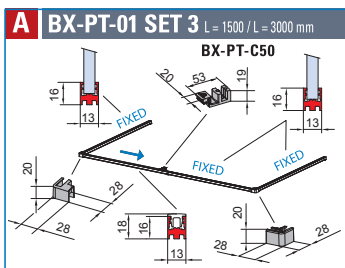

**PROFILI A TERRA / FLOOR PROFILES / BODENPROFILE ▶ 106**

xme556f

## LAVORAZIONE VETRO / GLASS PREPARATION / GLASBEARBEITUNG

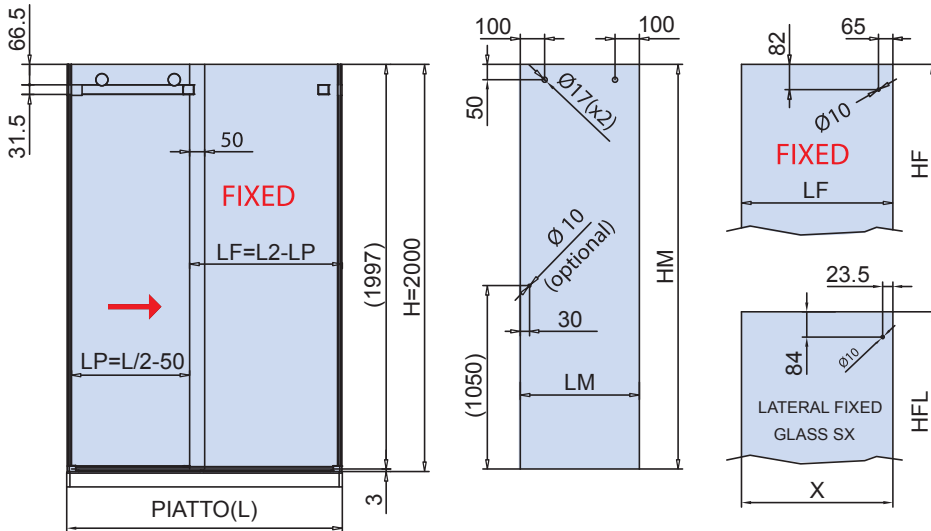

### CALCOLO VETRO / CALCULATION GLASS / GLASBERECHNUNG

L = PIATTO - SHOWER TRAY - DUSCHTASSE

L1=PIATTO (L)-5x2

L2=L1-2x8

Passaggio (LP) = L2 / 2 - 50

Vetro Mobile Larghezza (LM) = LP + 45

Vetro Fisso Larghezza (LF) = L2 - LP

X = CALCOLARE / CALCULATE / BERECHNEN

Vetro Mobile Altezza (HM) = H - 8 = 1992 mm

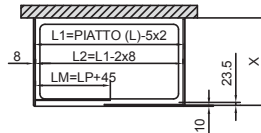

### PROFILI A TERRA / FLOOR PROFILES / BODENPROFILE ▶ 106

**BX-PT-01** STANDARD HF = H - 3 = 1997 mm HFL = H - 3

xme556e

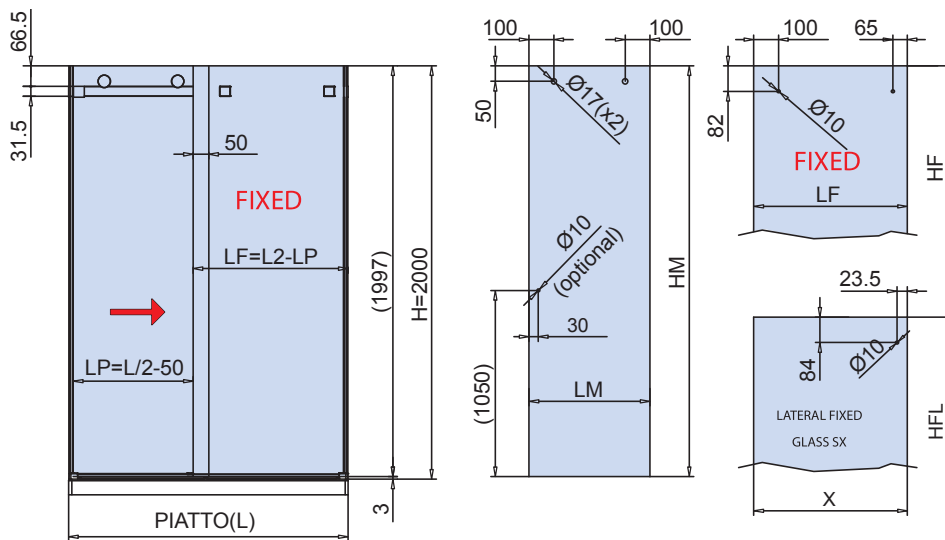

### CALCOLO VETRO / CALCULATION GLASS / GLASBERECHNUNG

L = PIATTO - SHOWER TRAY - DUSCHTASSE

L1 = PIATTO (L)-5x2

L2 = L1-2x8

Passaggio (LP) = L2 / 2 - 50

Vetro Mobile Larghezza (LM) = LP + 45

Vetro Fisso Larghezza (LF) = L2 - LP

X = CALCOLARE / CALCULATE / BERECHNEN

Vetro Mobile Altezza (HM) = H - 8 = 1992 mm

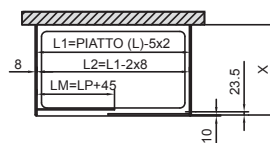

### PROFILI A TERRA / FLOOR PROFILES / BODENPROFILE ▶ 106

**BX-PT-01** STANDARD HF = H - 3 = 1997 mm HFL = H - 3

xme556f

### SET 3

DA TAGLIARE / ADJUST THE LENGTH / BELIEBIG KÜRZBAR ✂

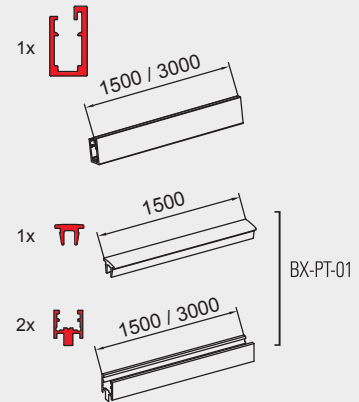

- Regolazione  $\pm 2$  mm.
- Adjustment  $\pm 2$  mm.
- Verstellung  $\pm 2$  mm.

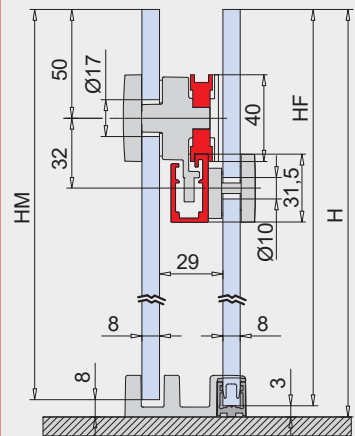

$HM = H - 8$   
 $HF = H - 3$   
 solo per / only for / nur für  
**BX-PT-01**

### OPTIONAL



L	LP	LM	LF	HM	HF	H	HFL
Piatto Shower tray Duschtaße	Passaggio luce Clear opening width Lichte Durchgangsbreite	Larghezza vetro mobile Sliding glass width Schiebeflügel Breite	Larghezza vetro fisso Side fixed glass width Seitenteil Breite	Altezza vetro mobile Sliding glass height Schiebeflügel Höhe	Altezza vetro fisso Side fixed glass height Seitenteil Höhe	Altezza doccia Shower height Duschkabine Höhe	Altezza vetro fisso laterale Side fixed glass height Seitenteil (seitlich) Höhe

SCORREVOLI

# BX-6000 SET 4 DX / BX-6000 SET 4 SX

MY METALGLAS

L = 1500mm / L = 3000mm

DOCCIA CON SPALLA IN VETRO / CORNER SHOWER WITH 2 FIXED PANELS  
ECKDUSCHE MIT 2 FESTSTEHENDEN GLASTAFELN

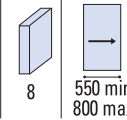

Fin. / Fin. / Oberf.

CR	NO
Cromo lucido	Nero opaco
Polished chrome	Matt black
Chrom glänzend	Matt schwarz

## COMPONENTI / COMPONENTS / EINZELTEILE

- BX-6000-C30 (1x)
- BX-6000-C10 (2x)
- BX-6000-C90 (1x)  
BX-6000-C81 (1x)
- BX-6000-C70-2 (1x)
- BX-6000-C70-1 (1x)
- OPTIONAL  
B-136/BX-PF-01 (2x)
- OPTIONAL

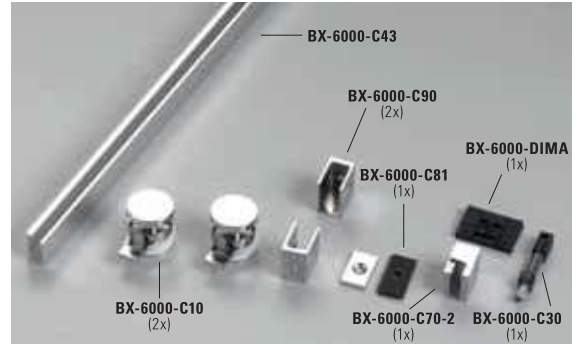
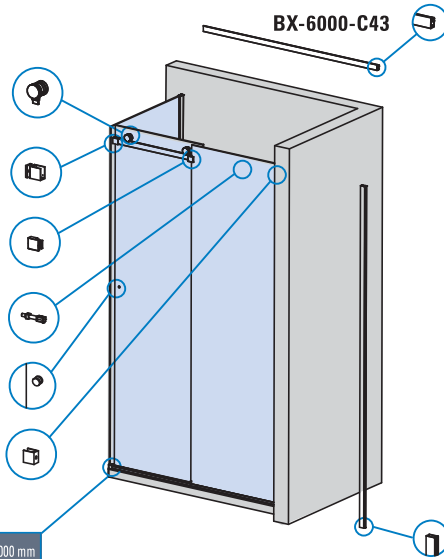

CARATTERISTICHE COMPONENTI /  
FEATURES COMPONENTS /  
EIGENSCHAFTEN EINZELTEILE ▶ 94



- Obbligatorio fissaggio a parete tramite profili a "U" o morsetti (non inclusi)
- Necessary wall-mounting with "U" profiles or clamps (not included)
- Verbindliche Befestigung an der Wand mit „U“-Profilen oder Wandhaltern (nicht inbegriffen)

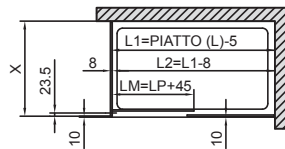
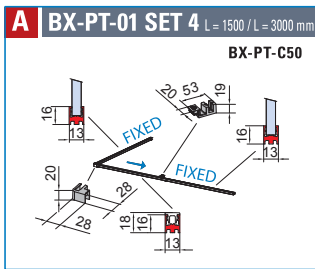

PROFILI A TERRA / FLOOR PROFILES / BODENPROFILE ▶ 106

xme556g

# BX-6020 SOFT-CLOSE SET 4



MY METALGLAS

L = 1500mm / L = 3000mm

DOCCIA CON SPALLA IN VETRO / CORNER SHOWER WITH 2 FIXED PANELS  
ECKDUSCHE MIT 2 FESTSTEHENDEN GLASTAFELN

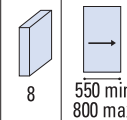

Fin. / Fin. / Oberf.

CR	NO
Cromo lucido	Nero opaco
Polished chrome	Matt black
Chrom glänzend	Matt schwarz

## COMPONENTI / COMPONENTS / EINZELTEILE

- BX-6000-SOFT-CLOSE (1x)
- BX-6000-C11 (1x)  
BX-6000-C12 (1x)
- BX-6000-C90 (1x)  
BX-6000-C81 (1x)
- BX-6000-C90 (1x)
- BX-6000-C70-1 (1x)
- OPTIONAL  
B-136/BX-PF-01 (2x)
- OPTIONAL

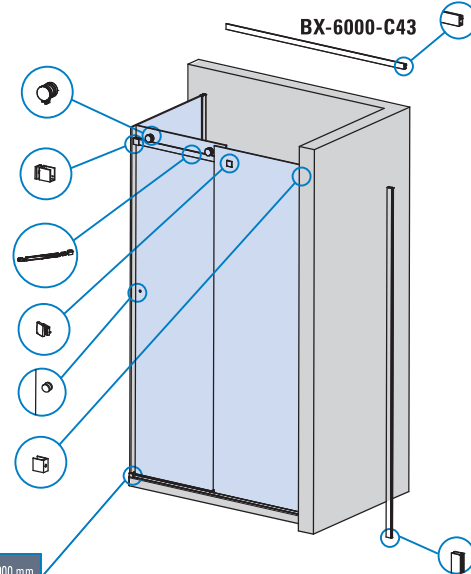

CARATTERISTICHE COMPONENTI /  
FEATURES COMPONENTS /  
EIGENSCHAFTEN EINZELTEILE ▶ 94

- Obbligatorio fissaggio a parete tramite profili a "U" o morsetti (non inclusi)
- Necessary wall-mounting with "U" profiles or clamps (not included)
- Verbindliche Befestigung an der Wand mit „U“-Profilen oder Wandhaltern (nicht inbegriffen)

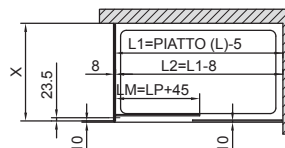
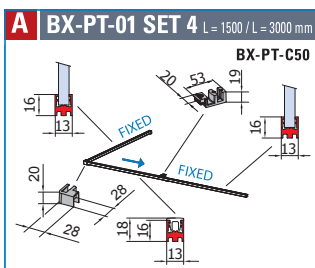

PROFILI A TERRA / FLOOR PROFILES / BODENPROFILE ▶ 106

xme556h



## BX-6000 / BX-6020 SOFT-CLOSE

### COMPONENTI / COMPONENTS / EINZELTEILE

SCORREVOLI



#### BX-6000-C43/ BX-6000-C40

- Binario
- Track profile
- Laufschiene

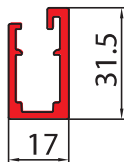

Cod.	Fin. / Fin. / Oberf.
BX-6000-C43-1500 mm	CR / NO
BX-6000-C43-3000 mm	CR / NO
BX-6000-C40-1000 x 1000 mm (2 pcs)	CR / NO

xme556i



#### BX-6000-C10

- Ruota con antigancio per set **senza** soft-close
- Roller with antijump for sets **without** soft-close
- Laufrolle und Aushebeschutz für sets **ohne** soft-close

CR - NO

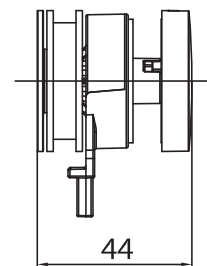
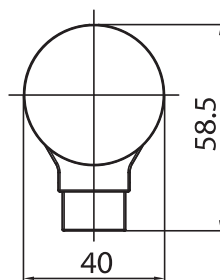

xme556i



#### BX-6000-C11

- Ruota con attivatore per versione soft-close
- Roller with antijump and soft-close activator
- Laufrolle mit Aushebeschutz und soft-close Mitnehmer

CR - NO

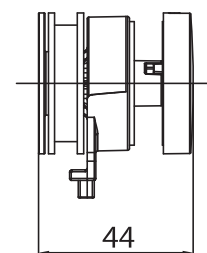
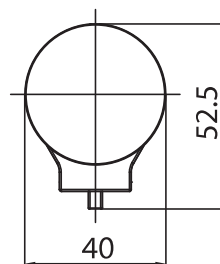

xme556i



#### BX-6000-C12

- Ruota con antigancio per versioni soft-close
- Roller with antijump for soft-close sets
- Laufrolle mit Aushebeschutz für soft-close sets

CR - NO

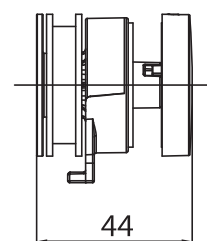
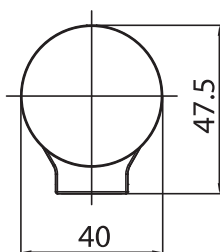

xme556i

**BX-6000-C70-2 DX (destra - right - rechts)**  
**BX-6000-C70-2 SX (sinistra - left - links)**

- Morsetto vetro fisso per tutti i set versione senza soft-close
  - Fixed glass clamp for all sets without soft-close
  - Klemme für Seitenteil für alle sets ohne soft-close
- CR - NO

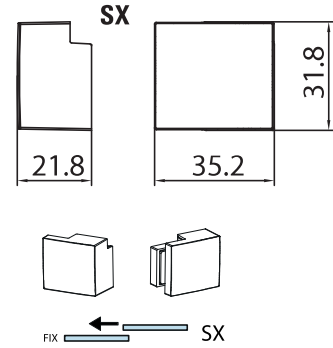
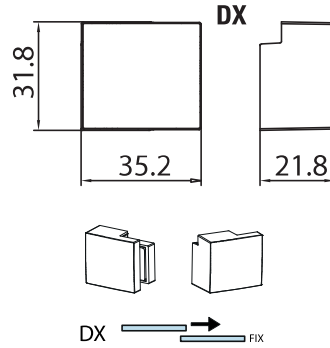

xme556i

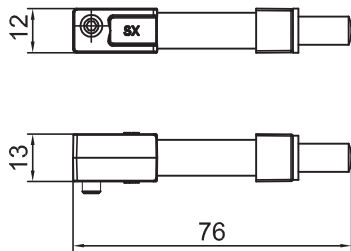
**BX-6000-C30**  
 • Stopper

xme556i

**BX-6000-C70-1**

- Morsetto vetro fisso per tutti i set versione con soft-close e per set 3 senza soft-close
  - Fixed glass clamp for all sets with soft-close and for set 3 without soft-close
  - Klemme für Seitenteil für alle sets mit soft-close und für set 3 ohne soft-close
- CR - NO



xme556i

**BX-6000-C90 DX**

- Attacco a parete destro per binario
  - Right wall connector for track profile
  - Wandhalter rechts für Laufschiene
- CR - NO

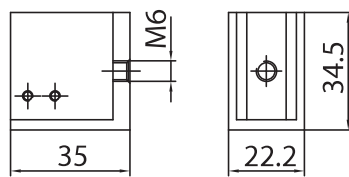

xme556i

**BX-6000-C90 SX**

- Attacco a parete sinistro per binario
  - Left wall connector for track profile
  - Wandhalter links für Laufschiene
- CR - NO

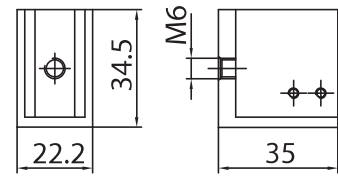

xme556i

**BX-6000-C81**

- Piastrina attacco a vetro per BX-6000-C90
  - Plate glass connector for BX-6000-C90
  - Platte Glashalter für BX-6000-C90
- CR - NO

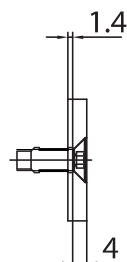

xme556i

**BX-PT-C50**

- Guida vetro scorrevole per applicazione con profilo a terra.
  - Floor guide sliding panel for installation with floor profile.
  - Schiebetür Bodenführung für Montage mit Bodenprofile.
- CR - NO

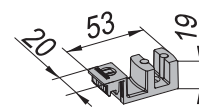

# BX-6000 / BX-6020 SOFT-CLOSE

COMPONENTI / COMPONENTS / EINZELTEILE

SCORREVOLI



### BX-6000-C20

- Connettore ad angolo per binari set 1
- Corner connector for track profiles set 1
- Winkelverbinder Laufschiene set 1

CR - NO

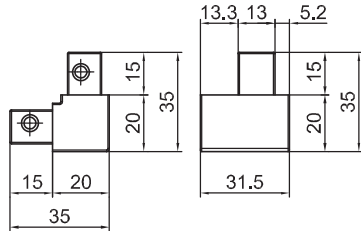

xme556l



### BX-6000-DIMA

- Dima per foratura per morsetto vetro fisso
- Template for drilling the track profile with the clamp
- Schablone für das Bohren der Laufschiene mit der Klemme

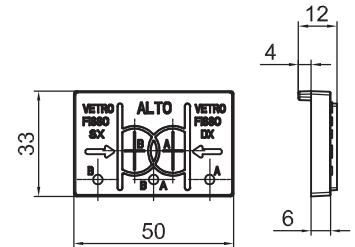

xme556l

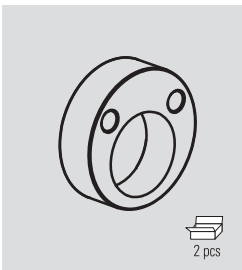

### BX-6000 ECCENTR

- Boccia eccentrica optional per regolazione vetro  $\pm 2,5$  mm. Attenzione per foro vetro anta mobile da 23 mm
- Eccentric bushing for glass adjustment  $\pm 2,5$  mm. Note well: glass hole 23 mm for sliding panel
- Exzentrisch Buchse für Glas Verstellung  $\pm 2,5$  mm. Achtung: Glasbohrung 23 mm für Schiebeflügel

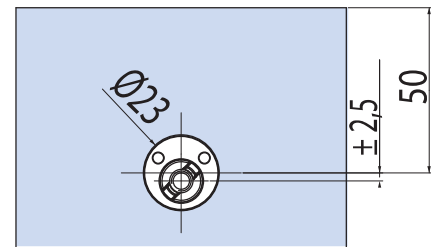
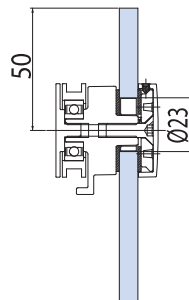
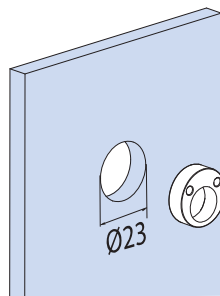

C-330-U



### BX-6000-SOFT-CLOSE

- Soft-close chiusura singola
- Single acting Soft-close
- Soft-close einzeln Wirkende

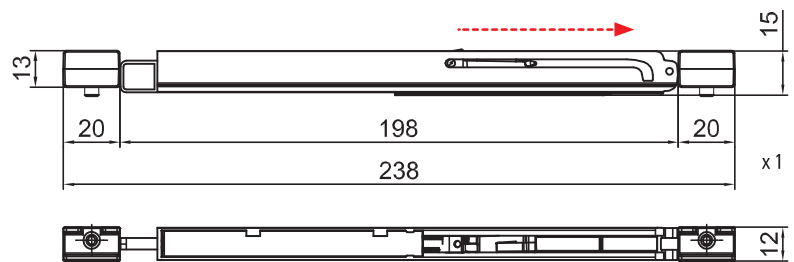

xme556l



### BX-PT-C58

- Profilo per fissaggio a terra o laterale
- Profile for floor and side installation
- Profil Boden- Wandmontage

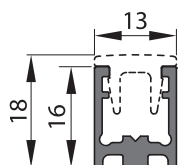

Cod.	Fin./Fin./Fin.
BX-PT-C58-1500 mm	CR / IX
BX-PT-C58-3000 mm	CR / IX

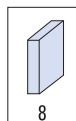

### BX-PT-C56

- Coperchio per profilo a terra per tratto entrata doccia
- Cover profile for floor profile, shower entry.
- Profilabdeckung Bodenprofil Duscheinstieg

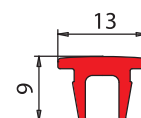

Cod.	Fin./Fin./Fin.
BX-PT-C56-1500 mm	CR / NO
BX-PT-C56-3000 mm	CR / NO



## BX-1501



SCORREVOLI



- Sistema scorrevole per box doccia disponibile per versioni in angolo, lineare e in nicchia. Possibilità di regolazione tramite ruota  $\pm 3$  mm.
- Sliding system for shower box, available for corners, single doors or for niche installations. Adjustment of carrying wheels  $\pm 3$  mm.
- Schiebetürsystem für Duschkabine, lieferbar für Eck-, Linear und Nischenduschen. Höheneinstellung der Räder  $\pm 3$  mm.

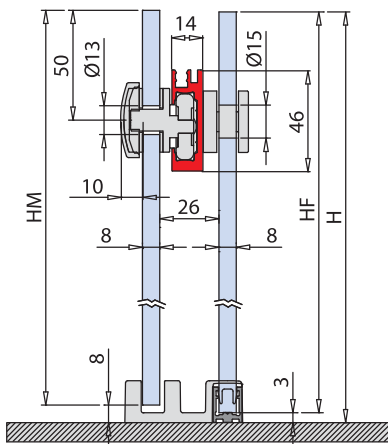

SCORREVOLI



SET 1

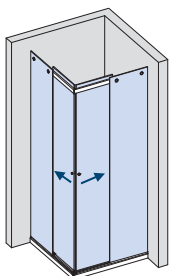

SET 2

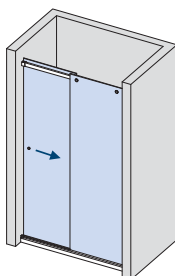

SET 3

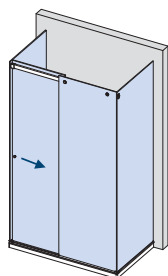

SET 4

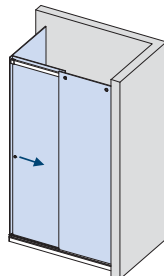

SET 5

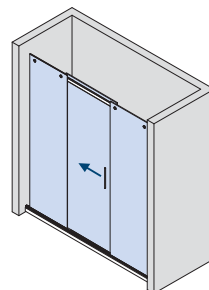

SET 6

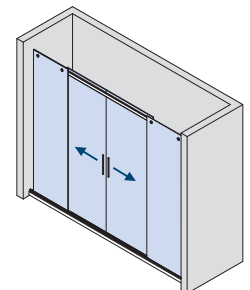



## LAVORAZIONE VETRO / GLASS PREPARATION / GLASBEARBEITUNG

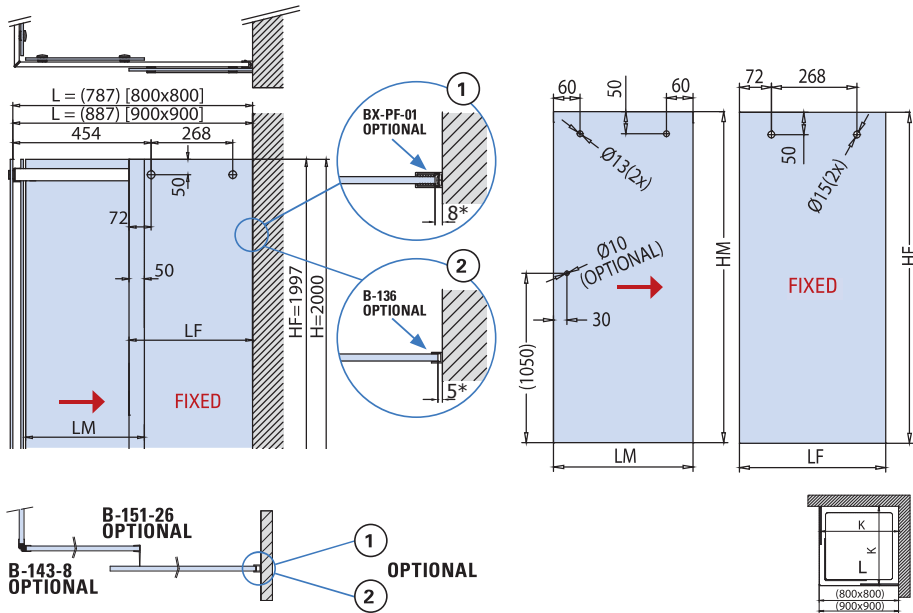

### CALCOLO VETRO / CALCULATION GLASS / GLASBEREICHNUNG

L = 800 x 800 mm (900 x 900 mm)

LM = (L - 5) / 2

LF = [(L - 5) / 2] - \* ① / \* ② (aria variabile / clearance / Spaltmaß)

HM = H - 8 = 1992 mm

### PROFILI A TERRA / FLOOR PROFILES / BODENPROFILE ▶ 106

**A** BX-PT-01 STANDARD HF = H - 3 = 1997 mm

**B** BX-PT-02 OPTIONAL HF = H = 2000 mm

**C** BX-PT-03 OPTIONAL HF = H = 2000 mm

xfb-050-A

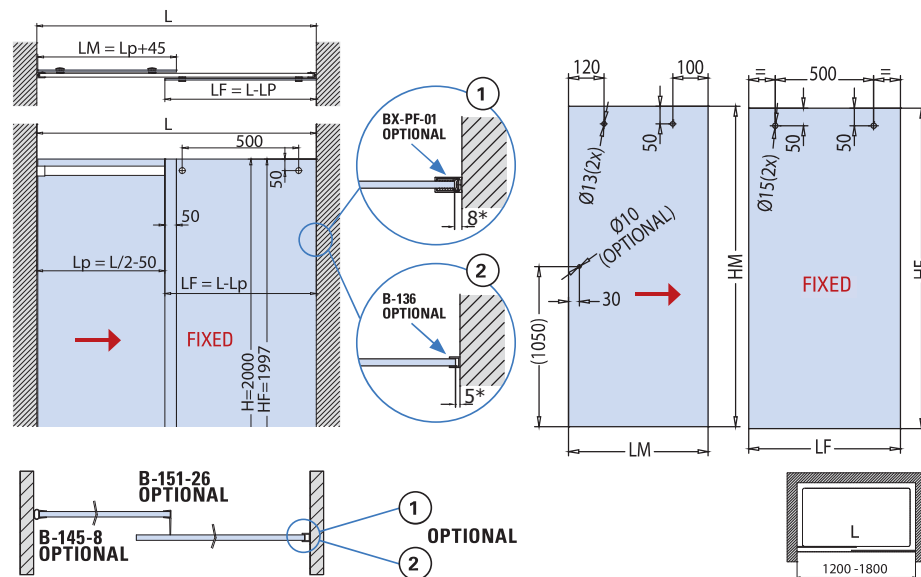

### CALCOLO VETRO / CALCULATION GLASS / GLASBEREICHNUNG

L = PIATTO - SHOWER TRAY - DUSCHASSE

LP = L / 2 - 50

LM = LP + 45

LF = L - LP - \* ① / \* ② (aria variabile / clearance / Spaltmaß)

HM = H - 8 = 1992 mm

### PROFILI A TERRA / FLOOR PROFILES / BODENPROFILE ▶ 106

**A** BX-PT-01 STANDARD HF = H - 3 = 1997 mm

**B** BX-PT-02 OPTIONAL HF = H = 2000 mm

**C** BX-PT-03 OPTIONAL HF = H = 2000 mm

xfb-050-B

**L**  
Piatto  
Shower tray  
Duschasse

**LM**  
Larghezza vetro mobile  
Sliding glass width  
Schiebeflügel Breite

**LF**  
Larghezza vetro fisso  
Side fixed glass width  
Seitenteil Breite

**HM**  
Altezza vetro mobile  
Sliding glass height  
Schiebeflügel Höhe

**HF**  
Altezza vetro fisso  
Side fixed glass height  
Seitenteil Höhe

**H**  
Altezza doccia  
Shower height  
Duschkabine Höhe

## SET 1 / SET 2

### DA TAGLIARE / ADJUST THE LENGTH / BELIEBIG KÜRZBAR ✂

- Forature per fissaggio vetro fisso (fatte dall'installatore).
- Holes in profile for fixed glass.
- Profile not predrilled.
- Bohrungen im Profil für Seitenteil Befestigung. Profil nicht vorgebohrt.

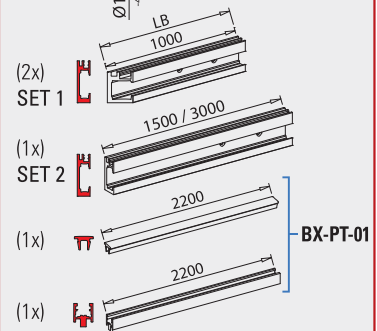
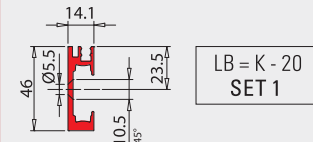

- Regolazione ruota ± 3 mm.
- Adjustment ± 3 mm.
- Verstellung ± 3 mm.

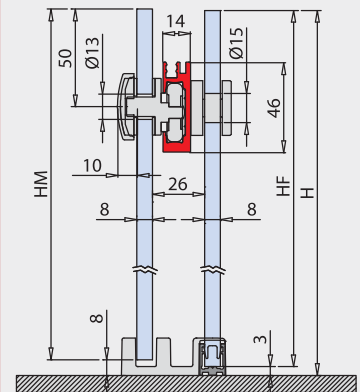

HM = H - 8

HF = H - 3

solo per / only for / nur für **A** BX-PT-01

## OPTIONAL



SCORREVOLI

## BX-1501 SET 3

L = 1500 mm / L = 3000 mm  
DOCCIA A U / U SHOWER / U DUSCHE

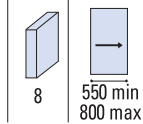

Fin. / Fin. / Oberf.

<b>CR</b> Cromo lucido Polished chrome Chrom glänzend	<b>IX</b> Effetto inox Inox effect Inox effekt
--	---

### COMPONENTI / COMPONENTS / EINZELTEILE

- BX-1501-C80 (2x)
- BX-1501-C10 (2x)
- BX-1501-C70 (2x)
- BX-1501-C30 (1x)
- OPTIONAL

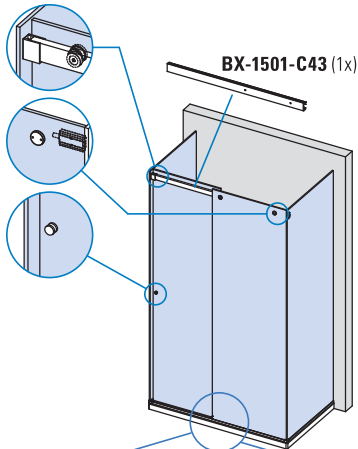

CARATTERISTICHE COMPONENTI /  
FEATURES COMPONENTS /  
EIGENSCHAFTEN EINZELTEILE ▶ 104

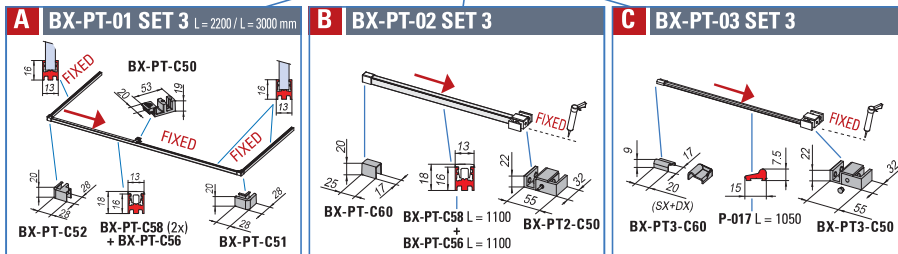

PROFILI A TERRA / FLOOR PROFILES / BODENPROFILE ▶ 106

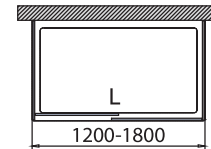

xfb-050-C

## BX-1501 SET 4

L = 1500 mm / L = 3000 mm  
DOCCIA CON SPALLA IN VETRO / CORNER SHOWER WITH 2 FIXED PANEL /  
ECKDUSCHE MIT 2 FESTSTEHENDEN GLASTAFELN

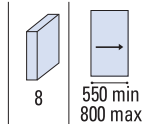

Fin. / Fin. / Oberf.

<b>CR</b> Cromo lucido Polished chrome Chrom glänzend	<b>IX</b> Effetto inox Inox effect Inox effekt
--	---

### COMPONENTI / COMPONENTS / EINZELTEILE

- BX-1501-C80 (1x)
- BX-1501-C10 (2x)
- BX-1501-C70 (2x)
- BX-1501-C90 (1x)
- BX-1501-C30 (1x)
- OPTIONAL

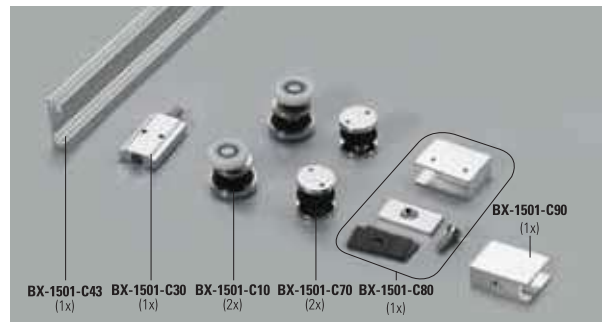
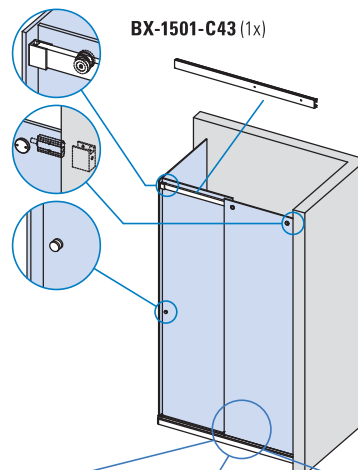

CARATTERISTICHE COMPONENTI /  
FEATURES COMPONENTS /  
EIGENSCHAFTEN EINZELTEILE ▶ 104

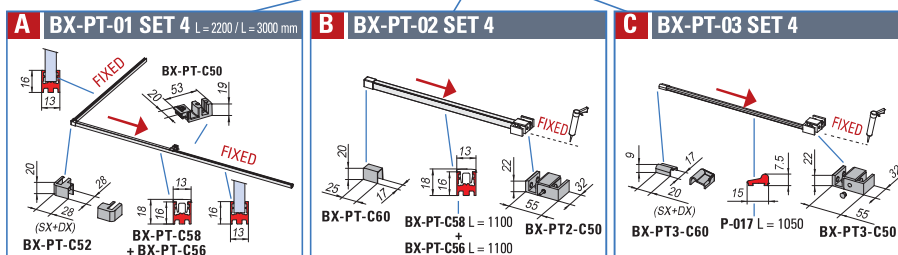

PROFILI A TERRA / FLOOR PROFILES / BODENPROFILE ▶ 106

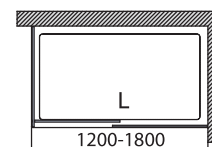

xfb-050-D

SCORREVOLI



# BX-1501

## COMPONENTI / COMPONENTS / EINZELTEILE

SCORREVOLI



### BX-1501-C43

- Binario
- Track profile
- Laufschiene

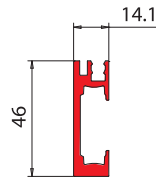

Cod.	Fin./Fin./Oberf.
BX-1501-C43-1500 mm	CR / IX
BX-1501-C43-3000 mm	CR / IX
BX-1501-C01-1000 x 1000 mm (2 pcs 45°)	CR / IX

xfb-077



### BX-1501-C10

- Ruota
  - Roller
  - Laufrolle
- CR - NS

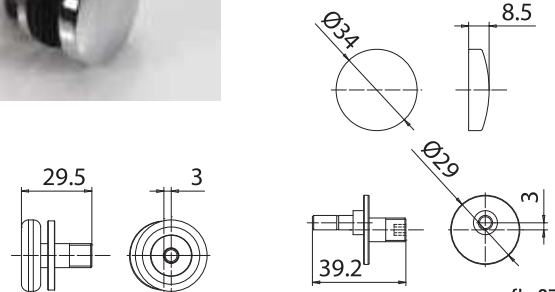

xfb-077



### BX-1501-C70

- Punto di fissaggio vetro fisso al binario
  - Fixing point for fixed glass and track profile
  - Punkthalter für Fixierung des Festteils auf Laufschiene
- CR - NS

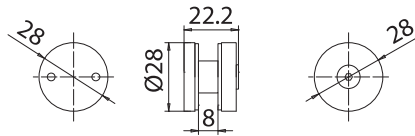

xfb-077



### BX-1501-C90 DX

- Attacco a parete destro per binario
  - Right wall connector for track profile
  - Wandhalter rechts für Laufschiene
- CR - NS

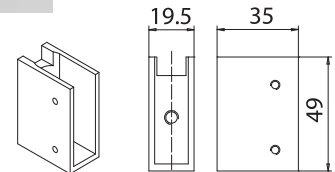

xfb-077



### BX-1501-C90 SX

- Attacco a parete sinistro per binario
  - Left wall connector for track profile
  - Wandhalter links für Laufschiene
- CR - NS

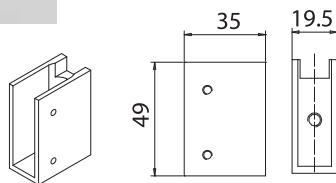

xfb-077



### BX-1501-C81

- Piastrina attacco a vetro
  - Plate glass connector for track profile
  - Platte Glashalter
- CR - NS

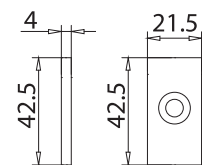

xfb-077



### BX-1501-C30

- Stopper
- CR - NS

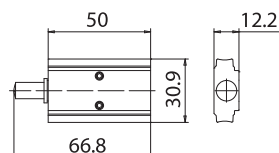

xfb-077



### BX-1501-C20

- Connettore ad angolo per binario
  - Corner connector for track profile
  - Winkelverbinder Laufschiene
- CR - NS

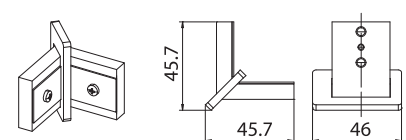

xfb-077



SCORREVOLI



**A** **BX-PT-01 STANDARD**  
**COMPONENTI / COMPONENTS / EINZELTEILE**

Per modelli: / For models: / Für Modelle:  
**BX-1501, BX-4000, BX-6000, BX-6020,**  
**BX-5000, BX-6050, BX-DIV5000**

- Vetro fisso nel profilo continuo H 16 mm.
- Fixed glass in shower entry floor profile H 16 mm.
- Festverglasung im Duscheinstieg Bodenprofil H 16 mm.

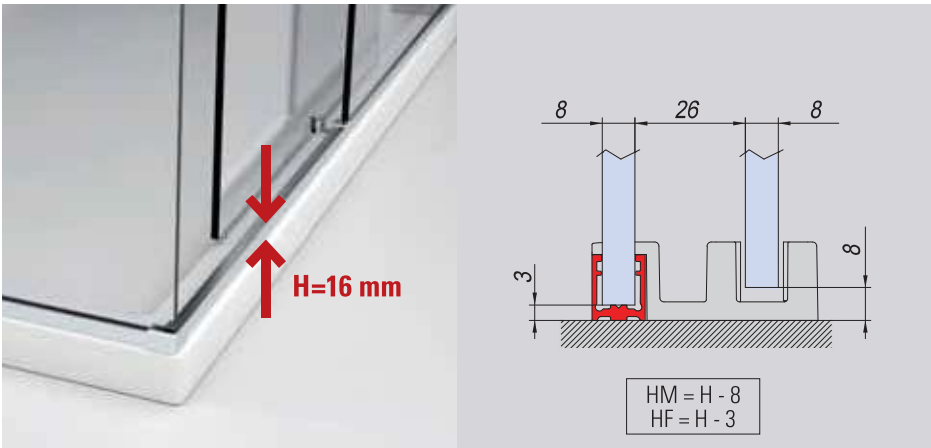

**SET ▶ 16**



**BX-PT-C58**

- Profilo per fissaggio a terra o laterale
- Profile for floor and side installation
- Profil Boden- Wandmontage

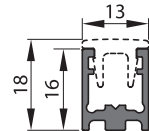

Cod.	Fin./Fin./Oberf.
BX-PT-C58-1500 mm	CR / NO / OR / IX / BI
BX-PT-C58-3000 mm	CR / NO / OR / IX / BI

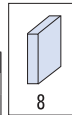

**BX-PT-C56**

- Coperchio per profilo a terra per tratto entrata doccia.
- Cover profile for floor profile, shower entry.
- Profilabdeckung Bodenprofil, Duscheinstieg.

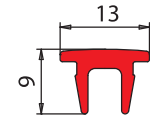

Cod.	Fin./Fin./Oberf.
BX-PT-C56-1500 mm	CR / NO / OR / IX / BI
BX-PT-C56-3000 mm	CR / NO / OR / IX / BI



**BX-PT-C50**

- Guida vetro scorrevole per applicazione con profilo a terra.
- Floor guide sliding panel for installation with floor profile.
- Schiebetür Bodenführung für Montage mit Bodenprofile.

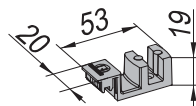

Cod.	Fin./Fin./Oberf.
BX-PT-C50-1500 mm	CR / NO / OR / IX / BI
BX-PT-C50-3000 mm	CR / NO / OR / IX / BI



**BX-PT-C57**

- Angolo 90° lato entrata doccia ad angolo per profili BX-PT-C58 / BX-PT-C56.
- Joint 90° corner entry for profiles BX-PT-C58 / BX-PT-C56.
- 90° Verbindung Eckeinstieg für Profile BX-PT-C58 / BX-PT-C56.

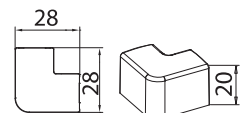

Cod.	Fin./Fin./Oberf.
BX-PT-C57-1500 mm	CR / NO / NS / BI / OR
BX-PT-C57-3000 mm	CR / NO / NS / BI / OR



**BX-PT-C51**

- Angolo 90° vetro fisso/vetro fisso per profilo BX-PT-C58.
- Joint 90° fixed/fixed glass for profile BX-PT-C58.
- 90° Verbindung 2 Festverglasungen für Profil BX-PT-C58.

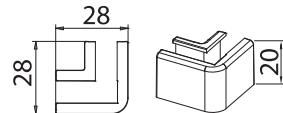

Cod.	Fin./Fin./Oberf.
BX-PT-C51-1500 mm	CR - NO - NS - BI - OR
BX-PT-C51-3000 mm	CR - NO - NS - BI - OR



**BX-PT-C52**

- Angolo 90° per lato entrata doccia e lato vetro fisso dx e sx per profili BX-PT-C58 / BX-PT-C56.
- Joint 90° entry and fixed glass, left and right for profiles BX-PT-C58 / BX-PT-C56.
- 90° Verbindung Einstieg-Festverglasung, Links und Rechts für Profile BX-PT-C58 / BX-PT-C56.

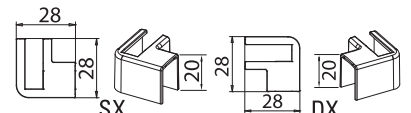

Cod.	Fin./Fin./Oberf.
BX-PT-C52-1500 mm	CR - NO - NS - BI - OR
BX-PT-C52-3000 mm	CR - NO - NS - BI - OR



**BX-PT-C60**

- Coperchietto finale per profili BX-PT-C58 / BX-PT-C56.
- Endcap for profiles BX-PT-C58 / BX-PT-C56.
- Endkappe für Profile BX-PT-C58 / BX-PT-C56.

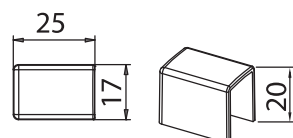

Cod.	Fin./Fin./Oberf.
BX-PT-C60-1500 mm	CR - NO - NS - BI - OR
BX-PT-C60-3000 mm	CR - NO - NS - BI - OR

- |  |   |  |  |   |  |
|--|---|--|--|---|--|
| <b>CR</b><br>Cromo lucido<br>Polished chrome<br>Chrom glänzend | <b>NO</b><br>Nero opaco<br>Matt black<br>Matt schwarz | <b>NS</b><br>Nickel satinato<br>Satin nickel<br>Ähnlich edelstahl matt | <b>IX</b><br>Effetto inox satinato<br>Inox effect<br>Inox effekt | <b>BI</b><br>Bianco opaco<br>Matt white<br>Weiss matt | <b>OR</b><br>Oro opaco<br>Matt gold<br>Gold matt |
|--|---|--|--|---|--|

SCORREVOLI

# B BX-PT-02 SOLO PORTA OPTIONAL

## COMPONENTI / COMPONENTS / EINZELTEILE

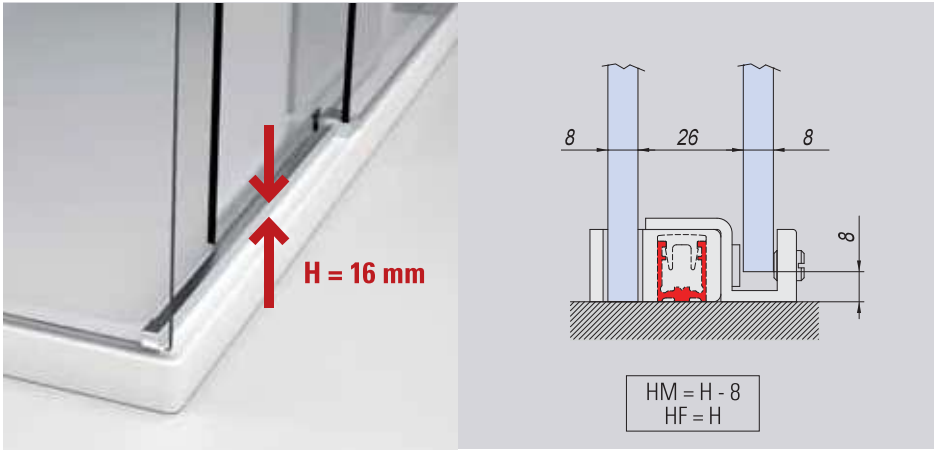

Per modelli: / For models: / Für Modelle:  
**BX-1501, BX-4000, BX-6000, BX-6020,**  
**BX-5000, BX-6050, BX-DIV5000**

- Vetro fisso su piatto doccia, solo profilo entrata H 16 mm.
- Fixed glass on shower tray, only shower entry floor profile H 16 mm.
- Festverglasung auf Duschtasse, Duscheinstieg Bodenprofil H 16 mm.

SET ► 16

SCORREVOLI



- BX-PT-C58**
- Profilo per fissaggio a terra o laterale
  - Profile for floor and side installation
  - Profil Boden- Wandmontage

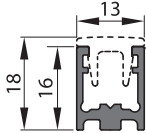

Cod.	Fin./Fin./Oberf.
BX-PT-C58-1500 mm	CR / NO / OR / IX / BI
BX-PT-C58-3000 mm	CR / NO / OR / IX / BI

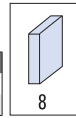

- BX-PT-C56**
- Coperchio per profilo a terra per tratto entrata doccia.
  - Cover profile for floor profile, shower entry.
  - Profilabdeckung Bodenprofil, Duscheinstieg.

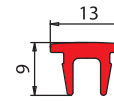

Cod.	Fin./Fin./Oberf.
BX-PT-C56-1500 mm	CR / NO / OR / IX / BI
BX-PT-C56-3000 mm	CR / NO / OR / IX / BI



- BX-PT2-C50**
- Guida vetro scorrevole per applicazione con profilo a terra.
  - Floor guide sliding panel for installation with floor profile.
  - Schiebetür Bodenführung für Montage mit Bodenprofile.

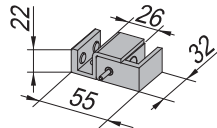

- BX-PT-C57**
- Angolo 90° lato entrata doccia ad angolo per profili BX-PT-C58 / BX-PT-C56.
  - Joint 90° corner entry for profiles BX-PT-C58 / BX-PT-C56.
  - 90° Verbindung Eckeinstieg für Profile BX-PT-C58 / BX-PT-C56.
  - CR - NO - NS - BI - OR

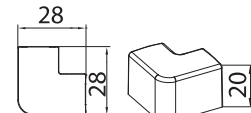

- BX-PT-C51**
- Angolo 90° vetro fisso/vetro fisso per profilo BX-PT-C58.
  - Joint 90° fixed/fixed glass for profile BX-PT-C58.
  - 90° Verbindung 2 Festverglasungen für Profil BX-PT-C58.
  - CR - NO - NS - BI - OR

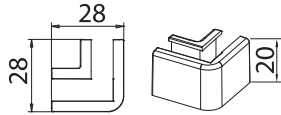

- BX-PT-C52**
- Angolo 90° per lato entrata doccia e lato vetro fisso dx e sx per profili BX-PT-C58 / BX-PT-C56.
  - Joint 90° entry and fixed glass, left and right for profiles BX-PT-C58 / BX-PT-C56.
  - 90° Verbindung Einstieg-Festverglasung, Links und Rechts für Profile BX-PT-C58 / BX-PT-C56.
  - CR - NO - NS - BI - OR

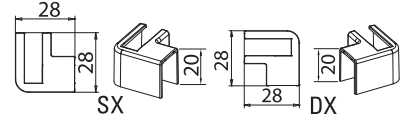

- BX-PT-C60**
- Coperchietto finale per profili BX-PT-C58 / BX-PT-C56.
  - Endcap for profiles BX-PT-C58 / BX-PT-C56.
  - Endcappe für Profile BX-PT-C58 / BX-PT-C56.
  - CR - NO - NS - BI - OR

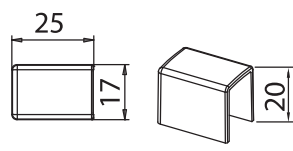

- V-012-REG**
- Guida a pavimento regolabile per vetro da 8 a 13,5 mm.
  - Floor guide adjustable for glass from 8 to 13,5 mm.
  - Bodenführung verstellbar für Glas von 8 bis 13,5mm.
  - AN - NS - CR

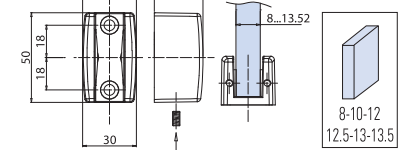
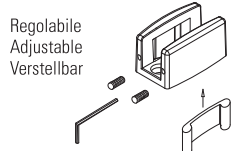

**CR**  
 Cromo lucido  
 Polished chrome  
 Chrom glänzend

**NO**  
 Nero opaco  
 Matt black  
 Matt schwarz

**AN**  
 Alluminio anodizzato  
 Aluminium anodized  
 Aluminium Silberfarbig

**NS**  
 Nickel satinato  
 Satin nickel  
 Ähnlich Edelstahl matt

**IX**  
 Effetto inox satinato  
 Matt white  
 Inox effect  
 Inox effekt

**BI**  
 Bianco opaco  
 Matt white  
 Weiss matt

**OR**  
 Oro opaco  
 Matt gold  
 Gold matt

**C**

**BX-PT-03 RASO DOCCIA OPTIONAL**  
COMPONENTI / COMPONENTS / EINZELTEILE

Per modelli: / For models: / Für Modelle:  
**BX-1501, BX-4000, BX-6000, BX-6020,**  
**BX-5000, BX-6050, BX-DIV5000**

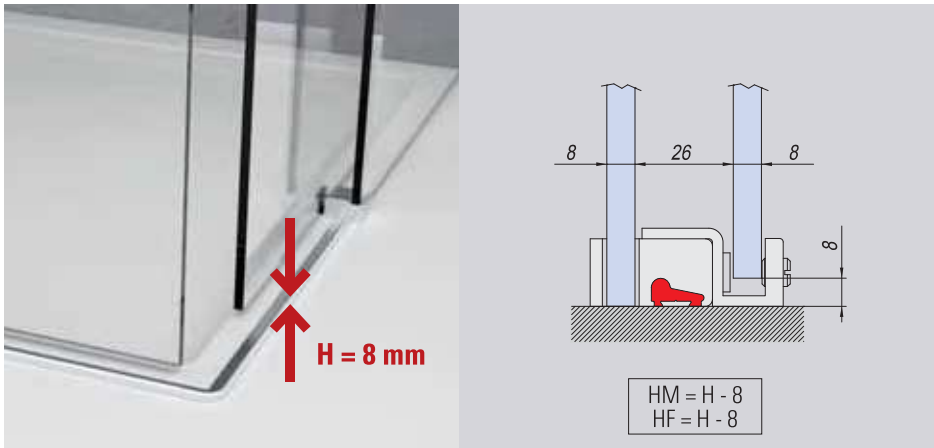

- Vetro fisso su piatto doccia, profilo entrata H 8 mm.
- Fixed glass on shower tray, shower entry profile H 8 mm.
- Festverglasung auf Duschtasse, Duscheinstieg Bodenprofil H 8 mm.

**SET ▶ 16**



**P-017**

- Profilo gocciolatoio
- Splash guard profile
- Schwallenschutz Profil

CR - NO

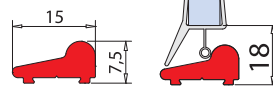

**B-147**  
Option



Cod.	Fin./Fin./Oberf.
P-017-2100 mm	CR / NO



**BX-PT3-C50**

- Guida vetro scorrevole per applicazione con profilo a terra P-017.
- Floor guide sliding panel for installation with floor profile P-017.
- Schiebetür Bodenführung für Montage mit Bodenprofil P-017.

CR

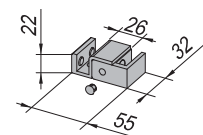

**BX-PT3-C57**

- Angolo 90° lato entrata doccia per profili P-017.
- Joint 90° corner entry for profiles P-017.
- 90° Verbindung Eckeinstieg für Profile P-017.

CR - NO

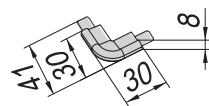

**BX-PT3-C60**

- Coperchietto finale per profili P-017, destro e sinistro.
- Endcap for profiles P-017, left and right.
- Endkappe für Profile P-017 Links und Rechts.

CR - NO

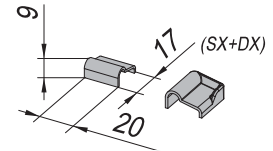

**V-012-REG**

- Guida a pavimento regolabile per vetro da 8 a 13,5 mm.
- Floor guide adjustable for glass from 8 to 13,5 mm.
- Bodenführung verstellbar für Glas von 8 bis 13,5 mm.

AN - NS - CR

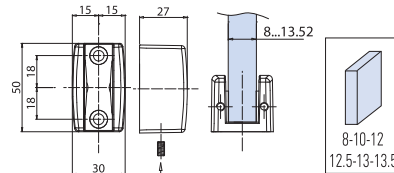

Regolabile  
Adjustable  
Verstellbar

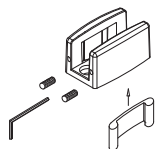

**V-012-EVO**

- Guida a pavimento regolabile per vetro 8-10-12 mm
- Floor guide adjustable for glass 8-10-12 mm
- Bodenführung verstellbar für Glas 8-10-12 mm

AN - NS - NO - CR

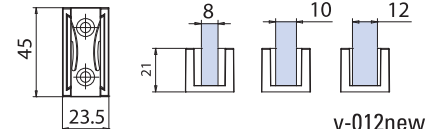
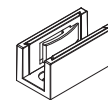

v-012new

**CR**  
Cromo lucido  
Polished chrome  
Chrom glänzend

**NO**  
Nero opaco  
Matt black  
Matt schwarz

**AN**  
Alluminio anodizzato  
Aluminium anodized  
Aluminium Silberfarbig

**NS**  
Nickel satinato  
Satin nickel  
Ähnlich Edelstahl matt

SCORREVOLI

