

MANIGLIONI MINI Ø 16 - Ø 15 / MANIGLIONI PULLHANDLES / STOSSGRIFFE



ROUND MINI Ø 16

- Maniglione inox
- Pullhandle inox
- Stossgriff inox

IX - IL

TL	225	300	
	135	•	Ø 9
A	200	•	Ø 9

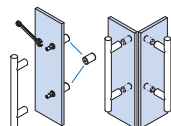
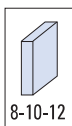
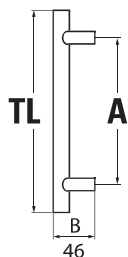

Option with Knob **B-177** page **175**

€ F.114



SQUARE MINI Ø 15

- Maniglione inox.
- Pullhandle inox.
- Stossgriff Inox.

IX - IL

TL	150	215	315	
	135	•	•	Ø 9
A	200	•	•	Ø 9
	300	•	•	Ø 9

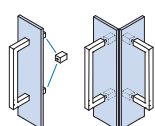
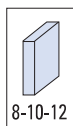

Option with Knob **B-178** page **175**

€ F.115



SQUARE Alu Ø 14

- Maniglione. Materiale: Alluminio
- Pullhandle. Material: Aluminium
- Stossgriff. Material: Aluminium

AN - CR

TL	174	206	334	
	160	•	•	Ø 8,5
A	192	•	•	Ø 8,5
	320	•	•	Ø 8,5

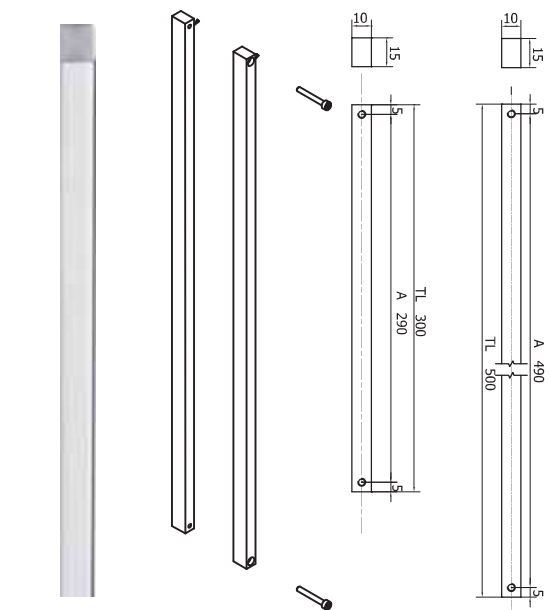
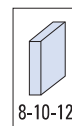

SQUARE 10

- Maniglione
- Pullhandle
- Stossgriff

AN - CR - NS

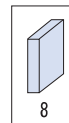

Ø	Code	A	TL		Materiale Material Material	Unit.	Finitura Finishes Oberfläche
10 x 15	10.41.53/290.300	290	300	8	Ottone Brass Messing	Paio Pair Paar	CR
10 x 15	10.41.63/290.300	290	300	8	Alluminio Aluminium Aluminium	Paio Pair Paar	CR EFFECT
10 x 15	10.41.73/290.300	290	300	8	Alluminio Aluminium Aluminium	Paio Pair Paar	NO
10 x 15	10.41.53/490.500	490	500	8	Ottone Brass Messing	Paio Pair Paar	CR
10 x 15	10.41.63/490.500	490	500	8	Alluminio Aluminium Aluminium	Paio Pair Paar	CR EFFECT

MANIGLIE
MANIGLIONI



Foro vetro
Glass hole
Glasbohrung

IX

Acciaio inox satinato
Satin stainless steel
Edelstahl matt

CR

Cromo lucido
Polished chrome
Chrom glänzend

AN

Alluminio anodizzato
Aluminium anodized
Aluminium Silberfarbig

IL

Acciaio inox lucido
Polished stainless steel
Edelstahl poliert

NS

Nickel satinato
Satin nickel
Ähnlich Edelstahl matt

MANIGLIONI Ø 20 / 25 / 30 - Ø 19 / 25 / 40

PULLHANDLES / STOSSGRIFFE

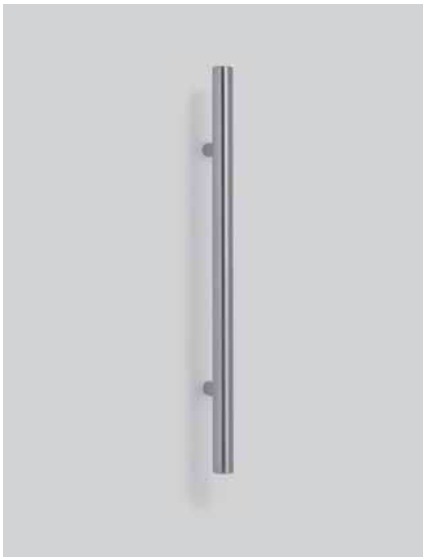

ROUND 02

- Maniglione
- Pullhandle
- Stossgriff

IX

F.46

Ø	A	200	300	500	650	1000	1040	1370	
20		•	•	•			•		Ø10
25			•	•	•				Ø12
30				•	•	•			Ø12
40									



SQUARE 41

- Maniglione
- Pullhandle
- Stossgriff

IX

F.48

Ø	A	200	300	650	
19		•			Ø10
25			•		Ø12
30					
40			•		Ø12



SQUARE 40

- Maniglione
- Pullhandle
- Stossgriff

IX

F.49

Ø	A	300	
20			
25		•	Ø12
30			
40			



ROUND 10

- Maniglione
- Pullhandle
- Stossgriff

IX

F.47

Ø	A	300	650	1000	
20		•			Ø10
25		•	•		Ø12
30			•		Ø12
40					



ROUND 01

- Maniglione
- Pullhandle
- Stossgriff

IX

F.50

Ø	A	200	300	350	400	650	
20		•	•				Ø10
25			•	•	•		Ø12
30			•		•		Ø12
40							



ROUND 11

- Maniglione
- Pullhandle
- Stossgriff

IX

F.51

Ø	A	350	620	
20				
25		•	•	Ø12
30				
40				





ROUND 03

- Maniglione
- Pullhandle
- Stossgriff

IX

Ø	A		
	200	275	350
		650	
20			
25		•	Ø12
30		• •	Ø12
40			



€ ▶ F.53



ROUND 08

- Maniglione
- Pullhandle
- Stossgriff

IX

Ø	A		
	400		
20			
25			
32		•	Ø12
40			



€ ▶ F.52



ROUND 09

- Maniglione
- Pullhandle
- Stossgriff

IX

Ø	A		
	300		
20			
25			
32		•	Ø12
40			



€ ▶ F.54

SET FISSAGGIO SCIOLTI
FIXATION SYSTEMS / BEFESTIGUNGSSYSTEME



FIX-01-20

- Set fissaggio singolo per maniglioni Ø 20 e filetto M 6
- Set installation for single pullhandle Ø 20 and thread M 6
- Befestigungsset für 1 Stück Stossgriff Ø 20 und Gewinde M 6

€ ▶ F.55

FIX-01-25

- Set fissaggio singolo per maniglioni Ø 25 e filetto M 6
- Set installation for single pullhandle Ø 25 and thread M 6
- Befestigungsset für 1 Stück Stossgriff Ø 25 und Gewinde M 6

€ ▶ F.56

FIX-01-30

- Set fissaggio singolo per maniglioni Ø 30 e filetto M 8
- Set installation for single pullhandle Ø 30 and thread M 8
- Befestigungsset für 1 Stück Stossgriff Ø 30 und Gewinde M 8

€ ▶ F.57

IX



FIX-03-20

- Set fissaggio paio per maniglioni Ø 20 e filetto M 6
- Set installation for pair pullhandles Ø 20 and thread M 6
- Befestigungsset für 1 Paar Stossgriffe Ø 20 und Gewinde M 6

€ ▶ F.58

FIX-03-25

- Set fissaggio paio per maniglioni Ø 25 e filetto M 6
- Set installation for pair pullhandles Ø 25 and thread M 6
- Befestigungsset für 1 Paar Stossgriffe Ø 25 und Gewinde M 6

€ ▶ F.59

FIX-03-30

- Set fissaggio paio per maniglioni Ø 30 e filetto M 8
- Set installation for pair pullhandles Ø 30 and thread M 8
- Befestigungsset für 1 Paar Stossgriffe Ø 30 und Gewinde M 8

€ ▶ F.60

IX



FIX-09-20

- Set fissaggio singolo per maniglioni porta legno Ø 20
- Set installation for single pullhandle Ø 20 - for wooden door
- Befestigungsset für 1 Stück Stossgriff Ø 20 für Holztür

€ ▶ F.61

FIX-09-25

- Set fissaggio singolo per maniglioni porta legno Ø 25
- Set installation for single pullhandle Ø 25 - for wooden door
- Befestigungsset für 1 Stück Stossgriff Ø 25 für Holztür

€ ▶ F.62

FIX-09-30

- Set fissaggio singolo per maniglioni porta legno Ø 30
- Set installation for single pullhandle Ø 30 - for wooden door
- Befestigungsset für 1 Stück Stossgriff Ø 30 für Holztür

€ ▶ F.63

IX