

GUIDA TECNICA PER LA SCELTA DEL TUO "PROFILO A TERRA" SECONDO TIPOLOGIE

TECHNICAL GUIDE FOR THE CHOICE OF YOUR "FLOOR PROFILE" BY TYPOLOGIES

AUSWAHL VON "BODENPROFIL" NACH VORHANDENEN KRITERIEN

Per i modelli: / For models: / Für Modelle:

**BX-1501, BX-4000, BX-6000, BX-6020,
BX-5000, BX-6050, BX-DIV5000**



SCORREVOLI

SET 1

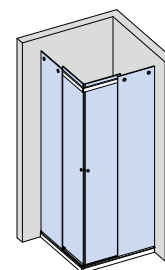

BX-PT-01 STANDARD

- Vetro fisso nel profilo continuo H 16 mm.
- Fixed glass in shower entry floor profile H 16 mm.
- Festverglasung im Duscheinstieg Bodenprofil H 16 mm.

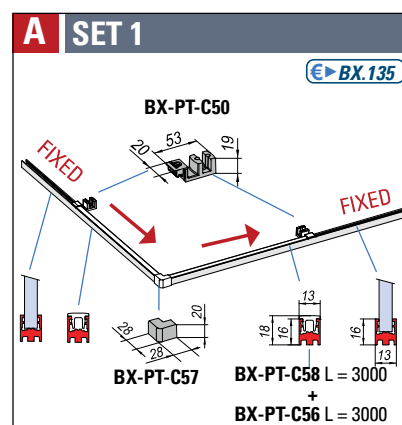
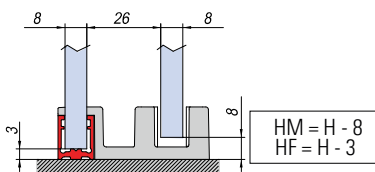

BX-PT-02 SOLO PORTA OPTIONAL

- Vetro fisso su piatto doccia, solo profilo entrata H 16 mm.
- Fixed glass on shower tray, only shower entry floor profile H 16 mm.
- Festverglasung auf Duschtasse, Duscheinstieg Bodenprofil H 16 mm.

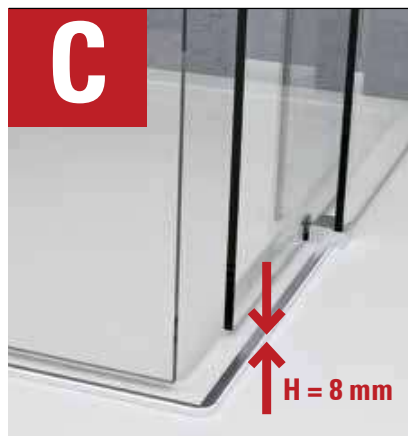
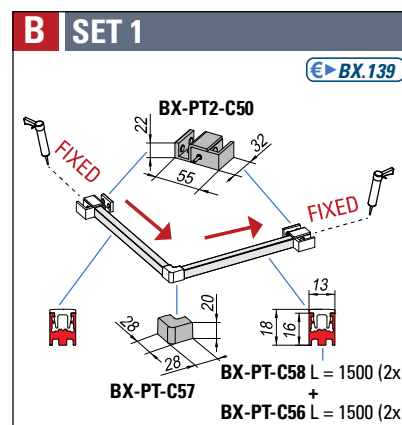
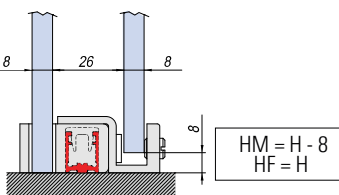

BX-PT-03 RASO DOCCIA OPTIONAL

- Vetro fisso su piatto doccia, profilo entrata H 8 mm.
- Fixed glass on shower tray, shower entry floor profile H 8 mm.
- Festverglasung auf Duschtasse, Duscheinstieg Bodenprofil H 8 mm.

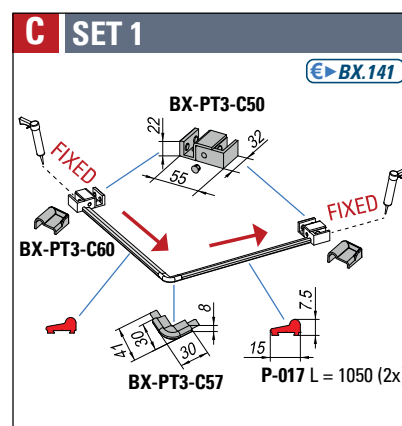
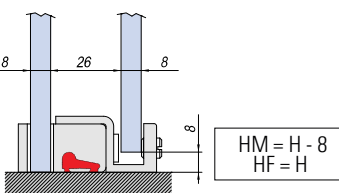

SCEGLIERE FONDO PREFERITO

CHOOSE FAVORITE FLOOR PROFILES / WÄHLEN SIE IHR GEWÜNSCHTES BODENPROFIL

SET 2

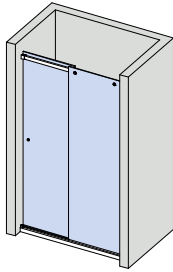

SET 3

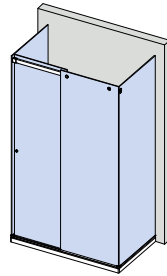

SET 4

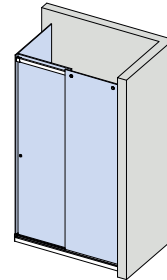

SCORREVOLI

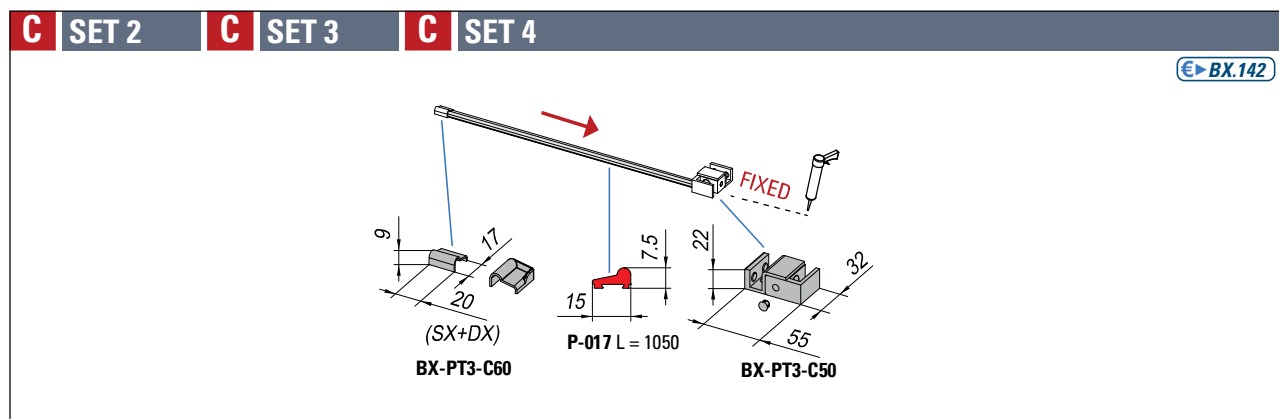
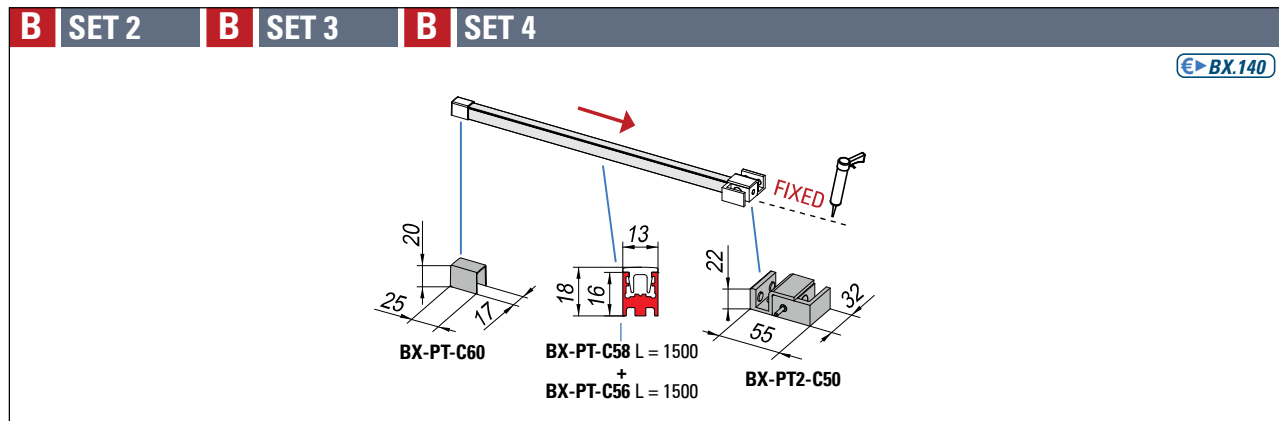
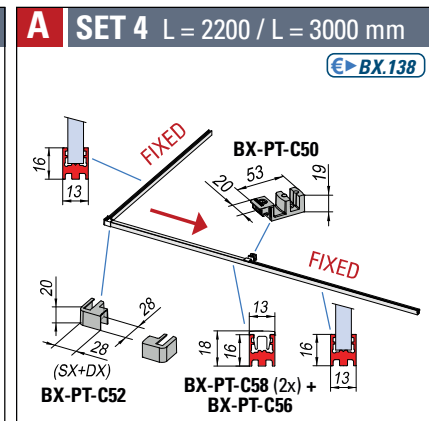
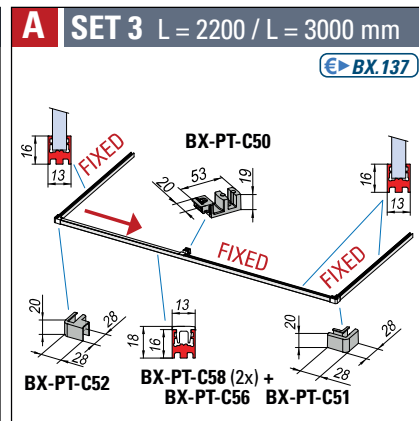
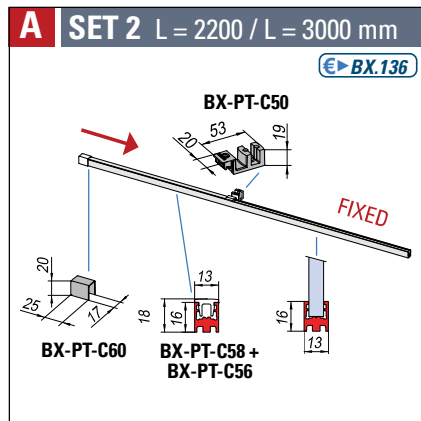

HM
Altezza vetro mobile
Sliding glass height
Schiebeflügel Höhe

HF
Altezza vetro fisso
Side fixed glass height
Seitenteil Höhe

BX-1501

COMPONENTI / COMPONENTS / EINZELTEILE



SCORREVOLI



BX-1501-C43

€ BX.127

- Binario
- Track profile
- Laufschiene

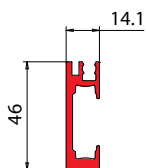

Cod.	Fin./Fin./Oberf.
BX-1501-C43-1500 mm	CR / IXE
BX-1501-C43-3000 mm	CR / IXE
BX-1501-C01-1000 x 1000 mm (2 pcs 45°)	CR / IXE

xfb-077



BX-1501-C10

€ BX.128

- Ruota
- Roller
- Laufrolle
- CR - NS

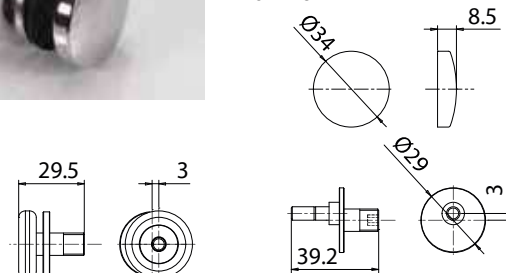

xfb-077



BX-1501-C70

€ BX.129

- Punto di fissaggio vetro fisso al binario
- Fixing point for fixed glass and track profile
- Punkthalter für Fixierung des Festteils auf Laufschiene
- CR - NS

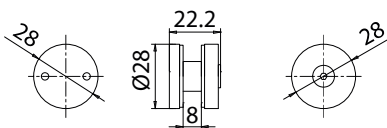

xfb-077



BX-1501-C90 DX

€ BX.130

- Attacco a parete destro per binario
- Right wall connector for track profile
- Wandhalter rechts für Laufschiene
- CR - NS

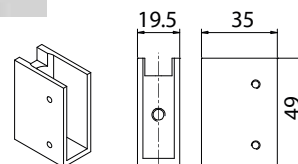

xfb-077



BX-1501-C90 SX

€ BX.131

- Attacco a parete sinistro per binario
- Left wall connector for track profile
- Wandhalter links für Laufschiene
- CR - NS

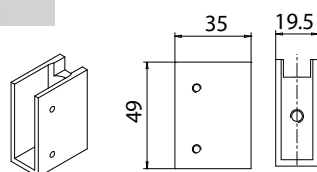

xfb-077



BX-1501-C81

€ BX.132

- Piastrina attacco a vetro
- Plate glass connector for track profile
- Platte Glashalter
- CR - NS

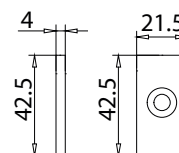

xfb-077



BX-1501-C30

€ BX.133

- Stopper
- CR - NS

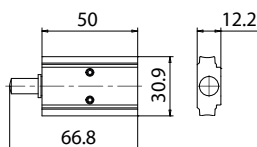

xfb-077



BX-1501-C20

€ BX.134

- Connettore ad angolo per binario
- Corner connector for track profile
- Winkelverbinder Laufschiene
- CR - NS

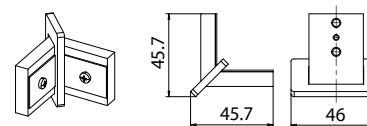

xfb-077



SCOPREVOLI



A

BX-PT-01 STANDARD
COMPONENTI / COMPONENTS / EINZELTEILE

Per modelli: / For models: / Für Modelle:
BX-1501, BX-4000, BX-6000, BX-6020,
BX-5000, BX-6050, BX-DIV5000

- Vetro fisso nel profilo continuo H 16 mm.
- Fixed glass in shower entry floor profile H 16 mm.
- Festverglasung im Duscheinstieg Bodenprofil H 16 mm.

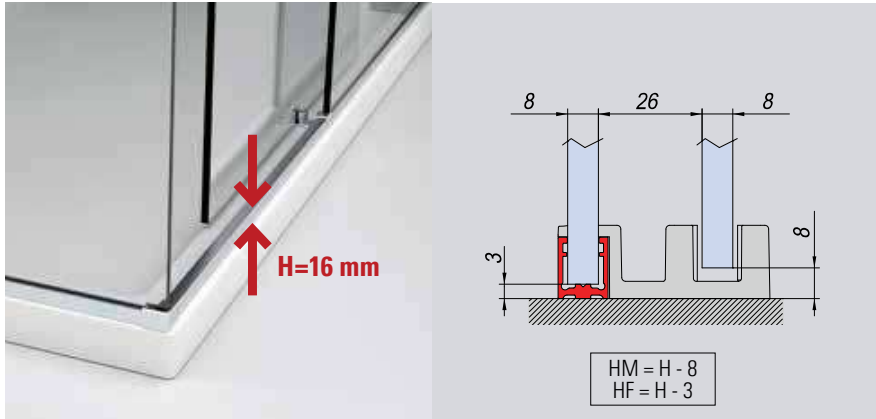

SET ▶ 16

SCORREVOLI



- BX-PT-C58** €▶ BX.144
- Profilo per fissaggio a terra o laterale
 - Profile for floor and side installation
 - Profil Boden- Wandmontage

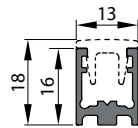

Cod.	Fin./Fin./Oberf.
BX-PT-C58-1500 mm	CR / NO / OR / IXE / BI
BX-PT-C58-3000 mm	CR / NO / OR / IXE / BI

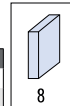

- BX-PT-C56** €▶ BX.145
- Coperchio per profilo a terra per tratto entrata doccia.
 - Cover profile for floor profile, shower entry.
 - Profilabdeckung Bodenprofil, Duscheinstieg.

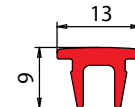

Cod.	Fin./Fin./Oberf.
BX-PT-C56-1500 mm	CR / NO / OR / IXE / BI
BX-PT-C56-3000 mm	CR / NO / OR / IXE / BI



- BX-PT-C50** €▶ BX.150
- Guida vetro scorrevole per applicazione con profilo a terra.
 - Floor guide sliding panel for installation with floor profile.
 - Schiebetür Bodenführung für Montage mit Bodenprofile.
- CR - NO

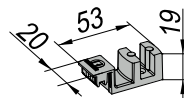

- BX-PT-C57** €▶ BX.152
- Angolo 90° lato entrata doccia ad angolo per profili BX-PT-C58 / BX-PT-C56.
 - Joint 90° corner entry for profiles BX-PT-C58 / BX-PT-C56.
 - 90° Verbindung Eckeinstieg für Profile BX-PT-C58 / BX-PT-C56.
- CR - NO - NS - BI - OR

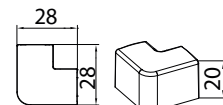

- BX-PT-C51** €▶ BX.154
- Angolo 90° vetro fisso/vetro fisso per profilo BX-PT-C58.
 - Joint 90° fixed/fixed glass for profile BX-PT-C58.
 - 90° Verbindung 2 Festverglasungen für Profil BX-PT-C58.
- CR - NO - NS - BI - OR

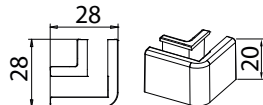

- BX-PT-C52** €▶ BX.155
- Angolo 90° per lato entrata doccia e lato vetro fisso dx e sx per profili BX-PT-C58 / BX-PT-C56.
 - Joint 90° entry and fixed glass, left and right for profiles BX-PT-C58 / BX-PT-C56.
 - 90° Verbindung Einstieg-Festverglasung, Links und Rechts für Profile BX-PT-C58 / BX-PT-C56.
- CR - NO - NS - BI - OR

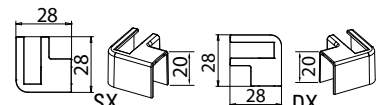

- BX-PT-C60** €▶ BX.153
- Coperchietto finale per profili BX-PT-C58 / BX-PT-C56.
 - Endcap for profiles BX-PT-C58 / BX-PT-C56.
 - Endkappe für Profile BX-PT-C58 / BX-PT-C56.
- CR - NO - NS - BI - OR

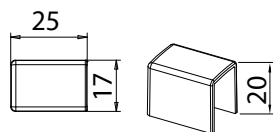

CR Cromo lucido Polished chrome Chrom glänzend	NO Nero opaco Matt black Matt schwarz	NS Nickel satinato Satin nickel Ähnlich edelstahl matt	IXE Effetto inox satinato Inox effect Inox effekt	BI Bianco opaco Matt white Weiss matt	OR Oro opaco Matt gold Gold matt
--	---	--	---	---	--

B BX-PT-02 SOLO PORTA OPTIONAL

COMPONENTI / COMPONENTS / EINZELTEILE

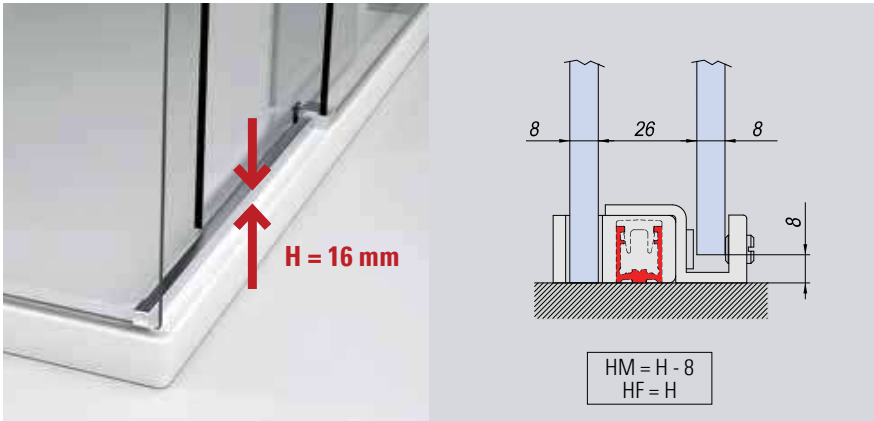

Per modelli: / For models: / Für Modelle:
BX-1501, BX-4000, BX-6000, BX-6020,
BX-5000, BX-6050, BX-DIV5000

- Vetro fisso su piatto doccia, solo profilo entrata H 16 mm.
- Fixed glass on shower tray, only shower entry floor profile H 16 mm.
- Festverglasung auf Duschtasse, Duscheinstieg Bodenprofil H 16 mm.

SCORREVOLI

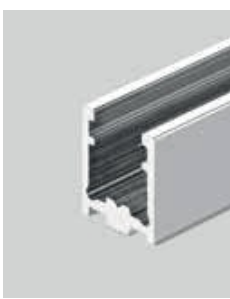
SET ▶ 16

BX-PT-C58

€▶ BX.144

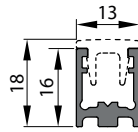
- Profilo per fissaggio a terra o laterale
- Profile for floor and side installation
- Profil Boden- Wandmontage

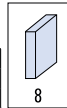

Cod.	Fin./Fin./Oberf.
BX-PT-C58-1500 mm	CR / NO / OR / IXE / BI
BX-PT-C58-3000 mm	CR / NO / OR / IXE / BI

BX-PT-C56

€▶ BX.145

- Coperchio per profilo a terra per tratto entrata doccia.
- Cover profile for floor profile, shower entry.
- Profilabdeckung Bodenprofil, Duscheinstieg.

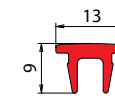

Cod.	Fin./Fin./Oberf.
BX-PT-C56-1500 mm	CR / NO / OR / IXE / BI
BX-PT-C56-3000 mm	CR / NO / OR / IXE / BI

BX-PT2-C50

€▶ BX.150

- Guida vetro scorrevole per applicazione con profilo a terra.
- Floor guide sliding panel for installation with floor profile.
- Schiebetür Bodenführung für Montage mit Bodenprofile.

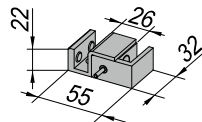
BX-PT-C57

€▶ BX.152

- Angolo 90° lato entrata doccia ad angolo per profili BX-PT-C58 / BX-PT-C56.
- Joint 90° corner entry for profiles BX-PT-C58 / BX-PT-C56.
- 90° Verbindung Eckeinstieg für Profile BX-PT-C58 / BX-PT-C56.

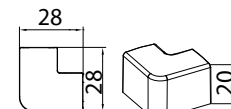
BX-PT-C51

€▶ BX.154

- Angolo 90° vetro fisso/vetro fisso per profilo BX-PT-C58.
- Joint 90° fixed/fixed glass for profile BX-PT-C58.
- 90° Verbindung 2 Festverglasungen für Profil BX-PT-C58.

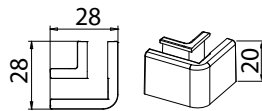
BX-PT-C52

€▶ BX.155

- Angolo 90° per lato entrata doccia e lato vetro fisso dx e sx per profili BX-PT-C58 / BX-PT-C56.
- Joint 90° entry and fixed glass, left and right for profiles BX-PT-C58 / BX-PT-C56.
- 90° Verbindung Einstieg-Festverglasung, Links und Rechts für Profile BX-PT-C58 / BX-PT-C56.

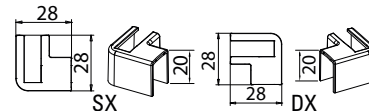
BX-PT-C60

€▶ BX.153

- Coperchietto finale per profili BX-PT-C58 / BX-PT-C56.
- Endcap for profiles BX-PT-C58 / BX-PT-C56.
- Endkappe für Profile BX-PT-C58 / BX-PT-C56.

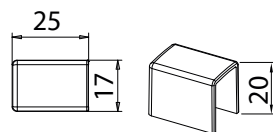
V-012-REG

€▶ BX.161

- Guida a pavimento regolabile per vetro da 8 a 13,5 mm.
- Floor guide adjustable for glass from 8 to 13,5 mm.
- Bodenführung verstellbar für Glas von 8 bis 13,5 mm.

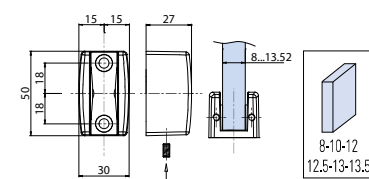

CR
 Cromo lucido
 Polished chrome
 Chrom glänzend

NO
 Nero opaco
 Matt black
 Matt schwarz

AN
 Alluminio anodizzato
 Aluminium anodized
 Aluminium Silberfarbig

NS
 Nickel satinato
 Satin nickel
 Ähnlich Edelstahl matt

IXE
 Effetto inox satinato
 Inox effect
 Inox effekt

BI
 Bianco opaco
 Matt white
 Weiss matt

OR
 Oro opaco
 Matt gold
 Gold matt

C **BX-PT-03 RASO DOCCIA OPTIONAL**
COMPONENTI / COMPONENTS / EINZELTEILE

Per modelli: / For models: / Für Modelle:
BX-1501, BX-4000, BX-6000, BX-6020,
BX-5000, BX-6050, BX-DIV5000

- Vetro fisso su piatto doccia, profilo entrata H 8 mm.
- Fixed glass on shower tray, shower entry floor profile H 8 mm.
- Festverglasung auf Duschtasse, Duscheinstieg Bodenprofil H 8 mm.

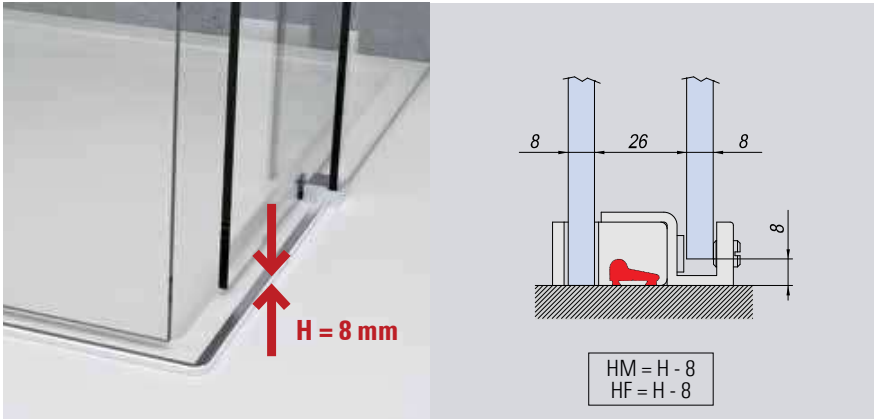

SET ▶ 16

SCORREVOLI



P-017

- Profilo gocciolatoio
- Splash guard profile
- Schwallschutz Profil

CR - NO

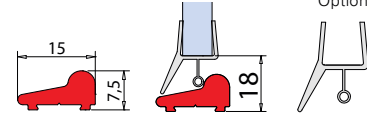

Cod.	Fin./Fin./Oberf.
P-017-2100 mm	CR / NO

€ **BX.255**



BX-PT3-C50

- Guida vetro scorrevole per applicazione con profilo a terra P-017.
- Floor guide sliding panel for installation with floor profile P-017.
- Schiebetür Bodenführung für Montage mit Bodenprofil P-017.

CR

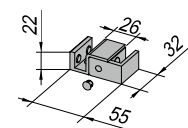

€ **BX.157**



BX-PT3-C57

- Angolo 90° lato entrata doccia per profili P-017.
- Joint 90° corner entry for profiles P-017.
- 90° Verbindung Eckeinstieg für Profile P-017.

CR - NO

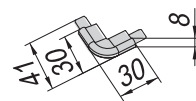

€ **BX.159**



BX-PT3-C60

- Coperchietto finale per profili P-017, destro e sinistro.
- Endcap for profiles P-017, left and right.
- Endkappe für Profile P-017 Links und Rechts.

CR - NO

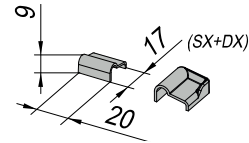

€ **BX.160**



V-012-REG

- Guida a pavimento regolabile per vetro da 8 a 13,5 mm.
- Floor guide adjustable for glass from 8 to 13,5 mm.
- Bodenführung verstellbar für Glas von 8 bis 13,5 mm.

AN - NS - CR

Regolabile
Adjustable
Verstellbar

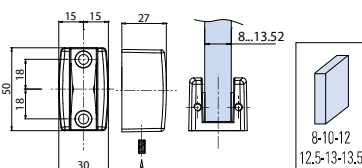
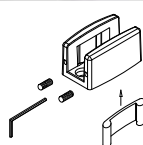

€ **BX.161**



V-012-EVO

- Guida a pavimento regolabile per vetro 8-10-12 mm
- Floor guide adjustable for glass 8-10-12 mm
- Bodenführung verstellbar für Glas 8-10-12 mm

AN - NS - NO - CR

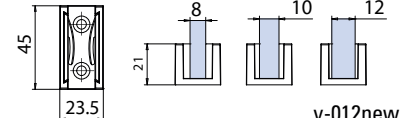
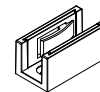

v-012new

CR
Cromo lucido
Polished chrome
Chrom glänzend

NO
Nero opaco
Matt black
Matt schwarz

AN
Alluminio anodizzato
Aluminium anodized
Aluminium Silberfarbig

NS
Nickel satinato
Satin nickel
Ähnlich Edelstahl matt

PROFILI A TERRA

FLOOR PROFILES / BODENPROFILE



BX-PT-C58

- Profilo per fissaggio a terra o laterale
- Profile for floor and side installation
- Profil Boden- Wandmontage

CR - NO - IXE - BI - OR



Cod.	Fin./Fin./Fin.
BX-PT-C58-1500 mm	CR / NO / IXE / BI / OR
BX-PT-C58-3000 mm	CR / NO / IXE / BI / OR

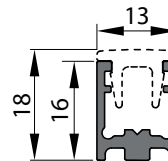

➔ BX.144

xla367b



BX-PT-C56

- Coperchio per profilo a terra per tratto entrata doccia.
- Cover profile for floor profile, shower entry.
- Profilabdeckung Bodenprofil, Duscheinstieg.

CR - NO - IXE - BI - OR

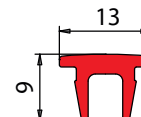

Cod.	Fin./Fin./Fin.
BX-PT-C56-1500 mm	CR / NO / IXE / BI / OR
BX-PT-C56-3000 mm	CR / NO / IXE / BI / OR

➔ BX.145

xla308



BX-PT-C57

- Angolo 90° lato entrata doccia ad angolo per profili BX-PT-C58 / BX-PT-C56.
- Joint 90° corner entry for profiles BX-PT-C58 / BX-PT-C56.
- 90° Verbindung Eckeinstieg für Profile BX-PT-C58 / BX-PT-C56.

CR - NO - NS - BI - OR

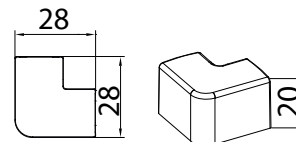

➔ BX.152

xla306



BX-PT-C51

- Angolo 90° vetro fisso/vetro fisso per profilo BX-PT-C58.
- Joint 90° fixed/fixed glass for profile BX-PT-C58.
- 90° Verbindung 2 Festverglasungen für Profil BX-PT-C58.

CR - NO - NS - BI - OR

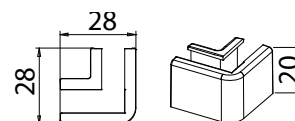

➔ BX.154

xla308



BX-PT-C52- DX / BX-PT-C52 SX

- Angolo 90° per lato entrata doccia e lato vetro fisso dx e sx per profili BX-PT-C58 / BX-PT-C56.
- Joint 90° entry and fixed glass, left and right for profiles BX-PT-C58 / BX-PT-C56.
- 90° Verbindung Einstieg-Festverglasung, Links und Rechts für Profile BX-PT-C58 / BX-PT-C56.

CR - NO - NS - BI - OR

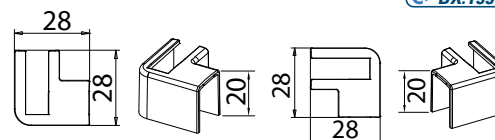

➔ BX.155

xla308



BX-PT-C60

- Coperchietto finale per profili BX-PT-C58 / BX-PT-C56.
- Endcap for profiles BX-PT-C58 / BX-PT-C56.
- Endkappe für Profile BX-PT-C58 / BX-PT-C56.

CR - NO - NS - BI - OR

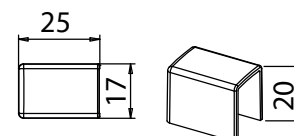

➔ BX.153

xla307

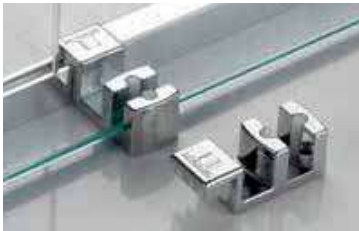

PROFILI

BX-PT-C50

- Guida vetro scorrevole per applicazione con profilo a terra.
 - Floor guide sliding panel for installation with floor profile.
 - Schiebetür Bodenführung für Montage mit Bodenprofile.
- CR - NO

 €► **BX.150**

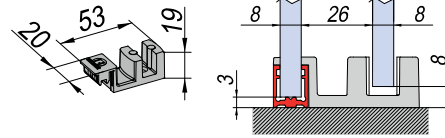
 HM = H - 8
 HF = H - 3

xla367

BX-3150

BX-4050
BX-3150 / BX-4050

 €► **BX.53** €► **BX.67**

- Guida vetro scorrevole con sistema di sgancio della porta per facilitare la pulizia per applicazione con profilo a terra. BX-PT-C58
- Floor guide sliding panel with quick release door function for easy cleaning for installation with floor profile. BX-PT-C58
- Schiebetür Bodenführung mit auslösbarem System um das Reinigen zu erleichtern für Montage mit Bodenprofile. BX-PT-C58

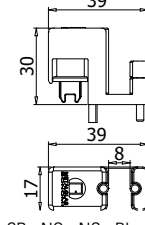
BX-3150

CR - NO - NS - BI - OR

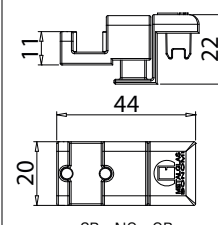
BX-4050

CR - NO - OR

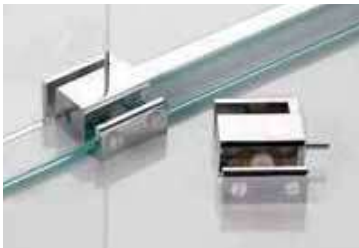
BX-PT2-C50

- Guida vetro scorrevole per applicazione con profilo a terra.
 - Floor guide sliding panel for installation with floor profile.
 - Schiebetür Bodenführung für Montage mit Bodenprofile.
- CR

 €► **BX.156**

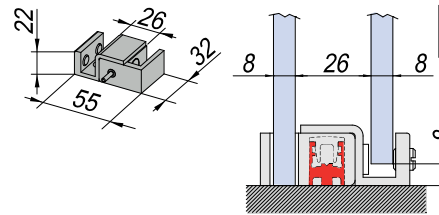
 HM = H - 8
 HF = H

xla367b

P-017

- Profilo gocciolatoio.
 - Splash guard profile.
 - Schwallschutz Profil.
- L = 2100 mm
 CR - NO

 €► **BX.255**

Cod.	Fin./Fin./Oberf.
P-017-2100 mm	CR / NO

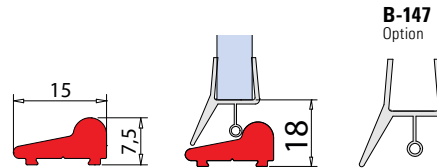

xme203

BX-PT3-C57

 €► **BX.159**

- Angolo 90° lato entrata doccia per profili P-017.
 - Joint 90° corner entry for profiles P-017.
 - 90° Verbindung EckEinstieg für Profile P-017.
- CR - NO

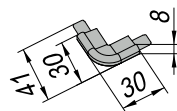

xla367c-2

BX-PT3-C60

 €► **BX.160**

- Coperchietto finale per profili P-017, destro e sinistro.
 - Endcap for profiles P-017, left and right.
 - Endkappe für Profile P-017 Links und Rechts.
- CR - NO

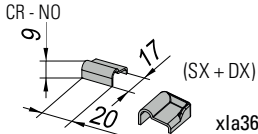

xla367c-2

BX-PT3-C50

- Guida vetro scorrevole per applicazione con profilo a terra P-017.
 - Floor guide sliding panel for installation with floor profile P-017.
 - Schiebetür Bodenführung für Montage mit Bodenprofil P-017.
- CR

 €► **BX.157**

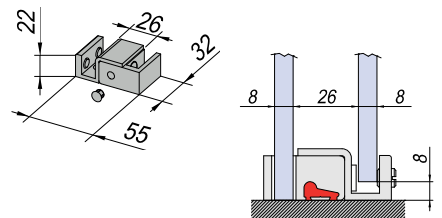
 HM = H - 8
 HF = H

xla367c-2

CR Cromo lucido Polished chrome Chrom glänzend	NO Nero opaco Matt black Schwarz matt	NS Nickel satinato Satin nickel Ähnlich Edelstahl matt	BI Bianco opaco Matt white Weiss matt	OR Oro opaco Matt gold Gold matt
--	---	--	---	--

