

# MANIGLIONI MINI Ø 16 - Ø 15 / MANIGLIONI PULLHANDLES / STOSSGRIFFE



## ROUND MINI Ø 16

- Maniglione inox
- Pullhandle inox
- Stossgriff inox

IX - IL

TL	225	300	
	135	•	Ø 9
A	200	•	Ø 9

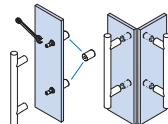
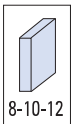
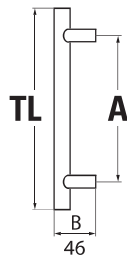

Option with Knob **B-177** page **▶ 175**

€ ▶ **F.114**



## SQUARE MINI Ø 15

- Maniglione inox.
- Pullhandle inox.
- Stossgriff Inox.

IX - IL

TL	150	215	315	
	135	•	•	Ø 9
A	200	•	•	Ø 9
	•	•	•	Ø 9

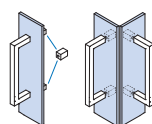
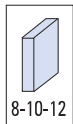

Option with Knob **B-178** page **▶ 175**

€ ▶ **F.115**



## SQUARE Alu Ø 14

- Maniglione. Materiale: Alluminio
- Pullhandle. Material: Aluminium
- Stossgriff. Material: Aluminium

AN - CR

TL	174	206	334	
	160	•	•	Ø 8,5
A	192	•	•	Ø 8,5
	•	•	•	Ø 8,5

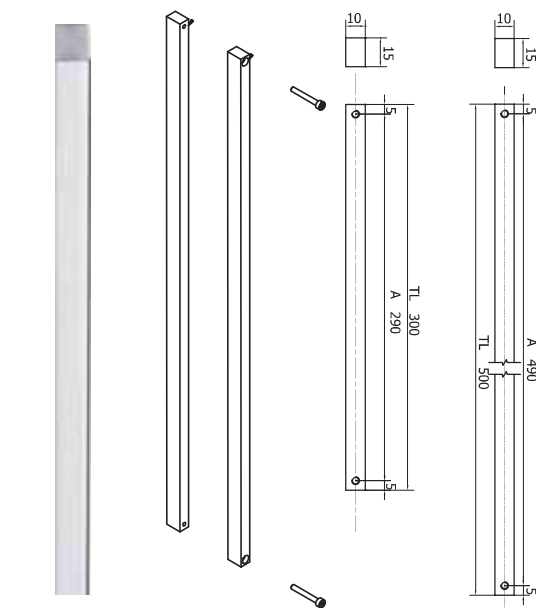
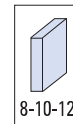
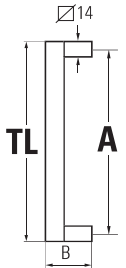

## SQUARE 10

- Maniglione
- Pullhandle
- Stossgriff

AN - CR - NS

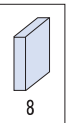

☑	Code	A	TL		Materiale Material Material	Unit. Pair Paar	Finitura Finishes Oberfläche
	10 x 15 10.41.53/290.300	290	300	8	Ottone Brass Messing	Paio Pair Paar	CR
	10 x 15 10.41.63/290.300	290	300	8	Alluminio Aluminium Aluminium	Paio Pair Paar	CR EFFECT
	10 x 15 10.41.73/290.300	290	300	8	Alluminio Aluminium Aluminium	Paio Pair Paar	NO
	10 x 15 10.41.53/490.500	490	500	8	Ottone Brass Messing	Paio Pair Paar	CR
	10 x 15 10.41.63/490.500	490	500	8	Alluminio Aluminium Aluminium	Paio Pair Paar	CR EFFECT

MANIGLIE  
MANIGLIONI



Foro vetro  
Glass hole  
Glasbohrung

**IX**  
Acciaio inox satinato  
Satin stainless steel  
Edelstahl matt

**CR**  
Cromo lucido  
Polished chrome  
Chrom glänzend

**AN**  
Alluminio anodizzato  
Aluminium anodized  
Aluminium Silberfarbig

**IL**  
Acciaio inox lucido  
Polished stainless steel  
Edelstahl poliert

**NS**  
Nickel satinato  
Satin nickel  
Ähnlich Edelstahl matt