

BOX DOCCIA SEPARÉ

SHOWERS AREA SEPARÉ
 DUSCHTRENNWAND SEPARÉ



SEPARÉ

► 178



- BARRE DI SUPPORTO QUADRE REGOLABILI
- ADJUSTABLE SQUARE SUPPORT BARS
- VERSTELLBARE ECKIGE STABILISATIONSSTANGEN

► 180



- BARRE DI SUPPORTO QUADRE
- SQUARE SUPPORT BARS
- ECKIGE STABILISATIONSSTANGEN

► 184



- BARRE DI SUPPORTO TONDE
- ROUND SUPPORT BARS
- RUNDE STABILISATIONSSTANGEN

► 185



SEPARÉ

SEPARÉ

BOX DOCCIA SEPARÉ / SHOWERS AREA SEPARÉ / DUSCHTRENNWAND SEPARÉ

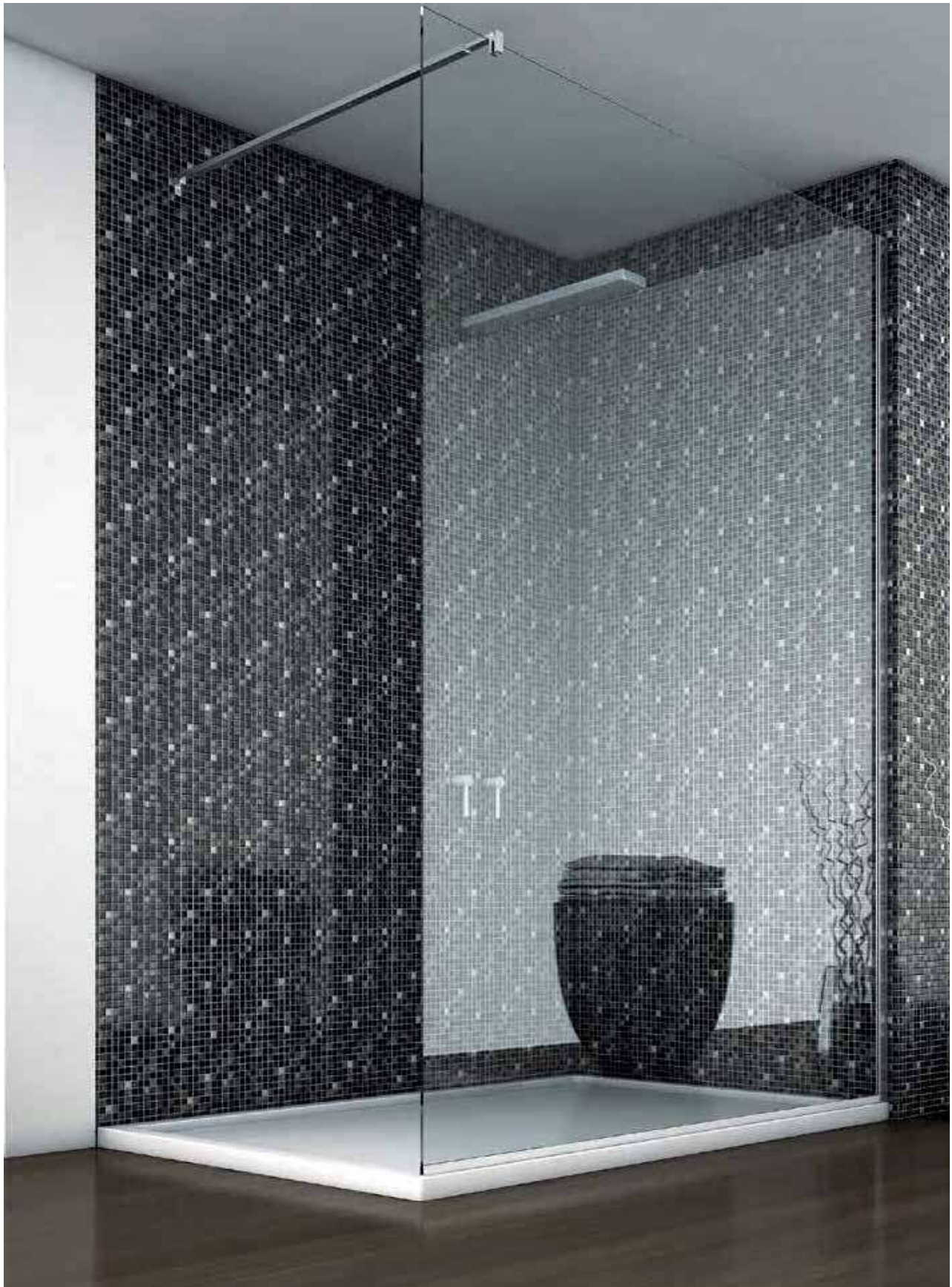

SEPARÉ

- Sistema per docce aperte tutto vetro senza porte.
- Walk-in systems for open shower areas without doors.
- Walk-in Systeme für offene Duschen ohne Türen.



- Alcune tipologie di applicazione
- Some application typologies
- Einigen kompositionsmöglichkeiten des system

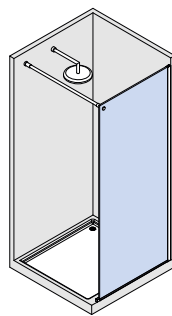
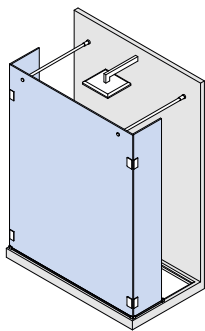
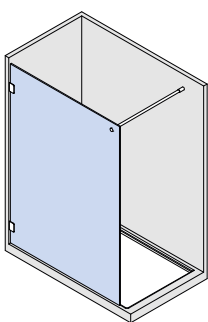

SEPARÉ

BARRE DI SUPPORTO QUADRE SNODATE SQUARE SQUARE SUPPORT BARS / ECKIGE STABILISATIONSTANGEN



B-328

- Barra di supporto snodata Square riducibile a piacere muro/vetro.
- Square adjustable support bar wall/glass, it is possible to cut the bar to adjust its size.
- Eckige Stabilisationsstange Wand/Glas, beliebig Kürzbar.

€ ▶ BX.302

ART.	Lunghezza (A) Length (A) Länge (A)	Finitura Finish Oberflächen		
		CR	NS	NO
B-328-500	500 mm	CR	NS	NO
B-328-1000	1000 mm	CR	NS	NO OR
B-328-1500	1500 mm		IL	NO OR

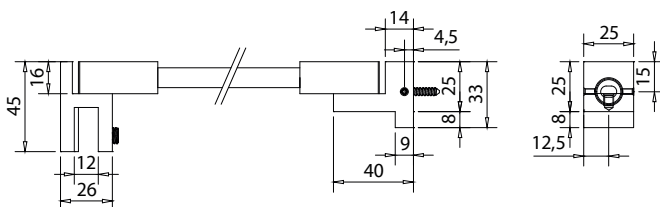

B-328-F

- Barra di supporto snodata a muro con attacco fisso a vetro B-324.
- Square support bar with adjustable wall connector and fixed glass connector B-324.
- Eckige Stabilisationsstange Wandanschluss vestellbar, Glasanschluss fest B-324.

€ ▶ BX.303

ART.	Lunghezza (A) Length (A) Länge (A)	Finitura Finish Oberflächen		
		CR	NS	NO
B-328-F-500	500 mm	CR	NS	NO
B-328-F-1000	1000 mm	CR	NS	NO
B-328-F-1500	1500 mm		IL	NO

C-272-A

COMPONENTI / COMPONENTS / EINZELTEILE



SEPARÉ



B-318

- Barra centrale Square riducibile a piacere.
- Square centre bar possible to cut to adjust its size.
- Eckige Stange beliebig Kürzbar.

€ ▶ BX.304

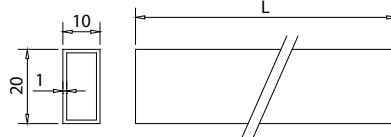

ART.	Lunghezza (A) Length (A) Länge (A)	Finitura Finish Oberflächen		
		CR	NS	NO
B-318-500	500 mm	CR	NS	NO
B-318-1000	1000 mm	CR	NS	NO OR
B-318-1500	1500 mm		IL	NO OR

CR
Cromo lucido
Polished chrome
Chrom glänzend

NS
Nickel satinato
Satin nickel
Ähnlich Edelstahl matt

IL
Acciaio inox lucido
Polished stainless steel
Edelstahl poliert

NO
Nero opaco
Matt black
Schwarz matt

OR
Oro opaco
Matt gold
Gold matt

B-320

- Attacco a vetro snodato per barra di supporto quadra.
- Adjustable glass connector for square support bar.
- Eckige Stabilisationsstange Glasanschluss verstellbar.

CR - NS - NO - OR

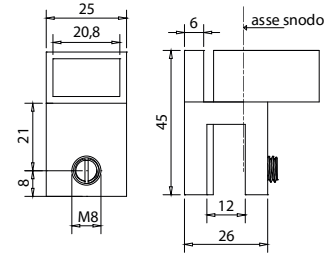

C-272-C

B-319

- Attacco a muro snodato per barra di supporto quadra.
- Adjustable wall connector for square support bar.
- Eckige Stabilisationsstange Wandanschluss verstellbar.

CR - NS - NO - OR

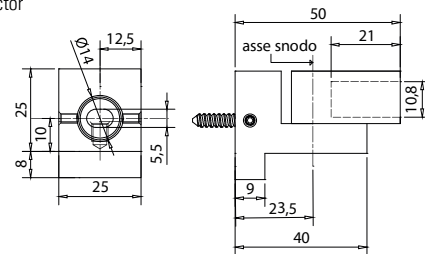

C-272-B

B-324

- Attacco a vetro chiuso.
- Glass connector for square support bar.
- Eckige Stabilisationsstange Glasanschluss.

CR - NS - NO

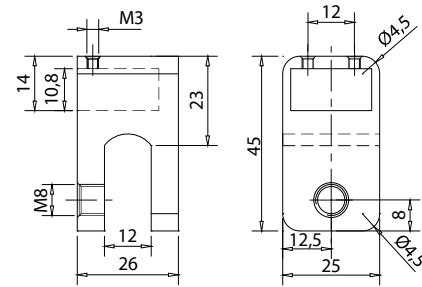

C-272-D

B-325

- Supporto centrale snodato per vetro fisso laterale.
- Adjustable T-connector side glass to support bar.
- Verstellbares T-Stück für Glas/Stange.

CR - NS - NO - OR

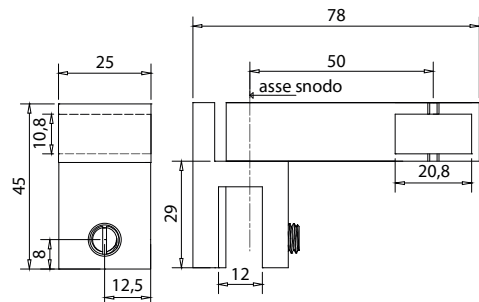

C-272-F

CR	NS
Cromo lucido	Nickel satinato
Polished chrome	Ŝatin nickel
Chrom gl�nzend	�hnlich Edelstahl matt



B-322

- Attacco a vetro in linea passante.
 - Glass connector in-line for passage support bar.
 - Glasanschluss in Linie für Stabilisationsstange durchgehend.
- CR - NS

➔ BX.308

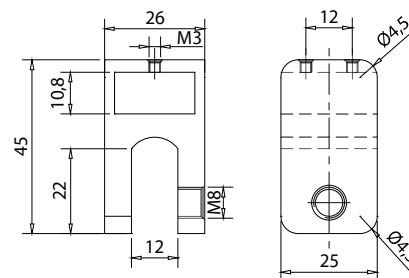

C-272-E



B-323

- Attacco a vetro chiuso per barra di supporto quadra.
 - Glass connector for square support bar.
 - Eckige Stabilisationsstange Glasanschluss.
- CR - NS

➔ BX.309

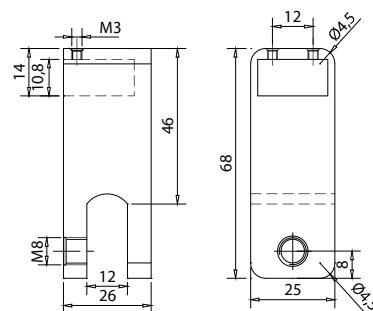

C-272-D



B-321

- Attacco a vetro 90° passante.
 - Glass connector 90° for passage support bar.
 - Glasanschluss 90° für Stabilisationsstange durchgehend.
- CR - NS

➔ BX.307

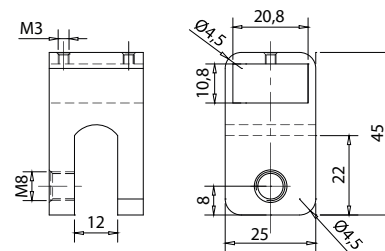

C-272-D



B-326

- Attacco snodato montaggio a vetro.
 - Adjustable connector for glass installation.
 - Verstellbarer Anschluss für Glasmontage.
- CR - NS

➔ BX.312

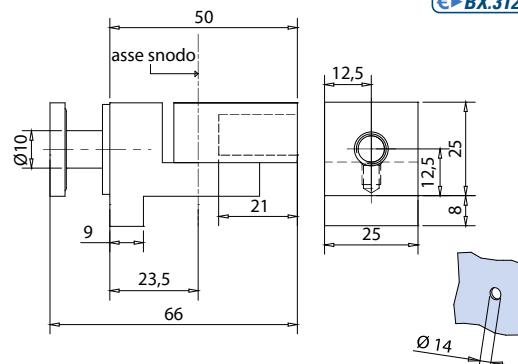

C-272-G

SEPARÉ

CR Cromo lucido Polished chrome Chrom glänzend	NS Nickel satinato Satin nickel Ähnlich Edelstahl matt	NO Nero opaco Matt black Schwarz matt	OR Oro opaco Matt gold Gold matt
----------------------------------------------------------------	------------------------------------------------------------------------	-------------------------------------------------------	--------------------------------------------------



B-327

- Attacco snodato doppio.
 - 2-Ways adjustable connector.
 - Verstellbarer Anschluss 2-Wege
- CR - NS

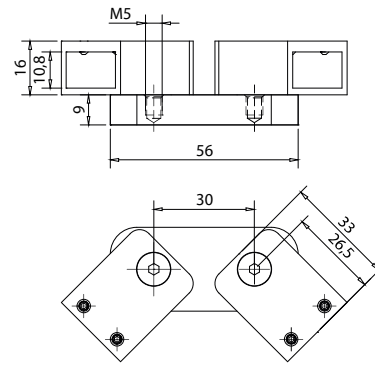

➔ BX.313

C-272-H



SEPARÉ

BARRE DI SUPPORTO QUADRE SQUARE SUPPORT BARS / ECKIGE STABILISATIONSSTANGEN

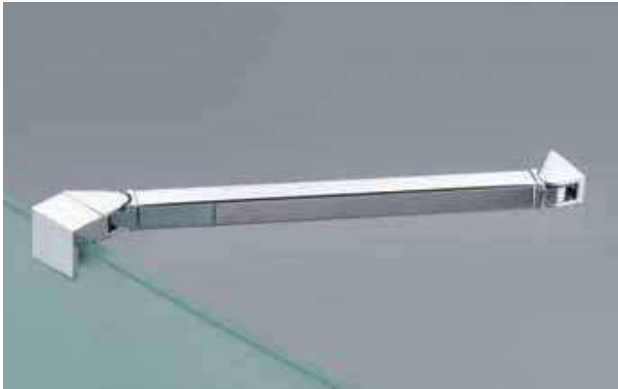

B-511-220 / B-511-370

- Barra di supporto quadra angolare snodata vetro/muro.
- Square support bar wall/glass.
- Eckige Stabilisationsstange Wand/Glas.

CR - NS

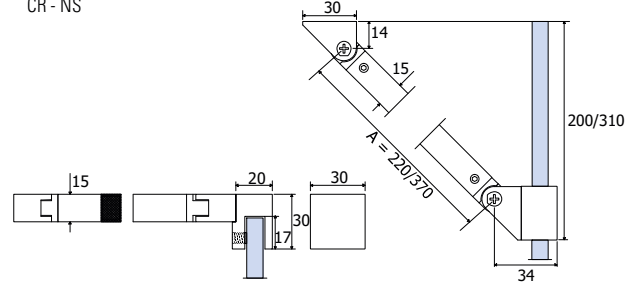

€ BX.314

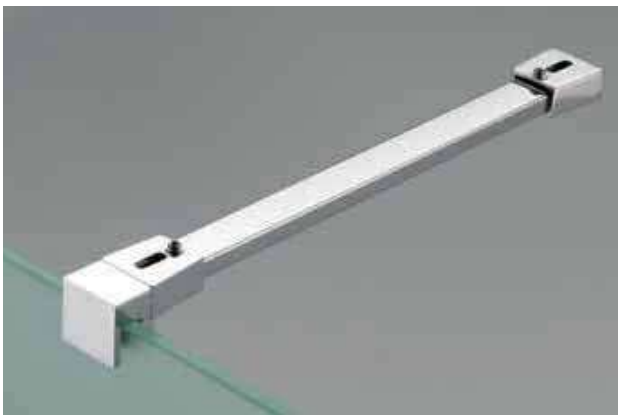

B-521

- Barra di supporto quadra a 90° vetro/muro.
- Square support bar wall/glass 90°.
- Eckige Stabilisationsstange Wand/Glas 90°.

CR - NS

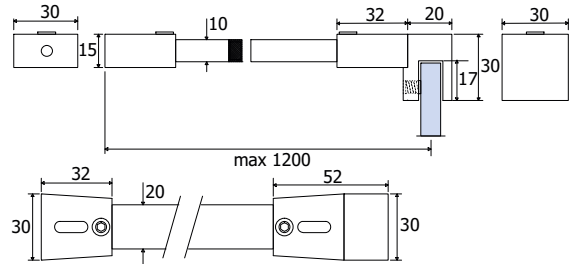

€ BX.316

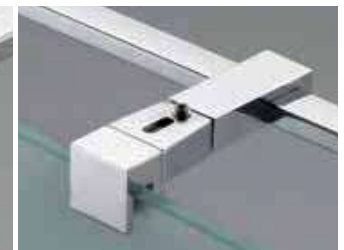
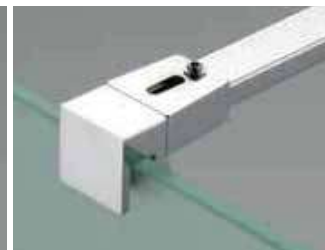

B-529

€ BX.317

- Barra centrale quadra per B-527, B-528 L=1200 mm.
- Square support bar for B-527, B-528 L=1200 mm.
- Eckige Stabilisationsstange für B-527, B-528 L=1200 mm.

CR - NS

B-528

€ BX.318

- Attacco a muro per barra di supporto quadra B-529.
- Wall fitting for B-529 support bar.
- B-529 Stabilisationsstange Wandanschluss.

CR - NS

B-527

€ BX.319

- Attacco a vetro per la barra quadra B-529.
- Glass fitting for support bar B-529.
- Glasanschluss für Stabilisationsstange B-529 zu können.

CR - NS

B-523

€ BX.320

- Supporto centrale per vetro fisso laterale con barra B-521 / B-529.
- Middle connector glass fitting/Square bar support B-521 / B-529.
- Mittelverbinder Glasanschluss/Square Stabilisationsstange B-521 / B-529.

CR



SEPARÉ

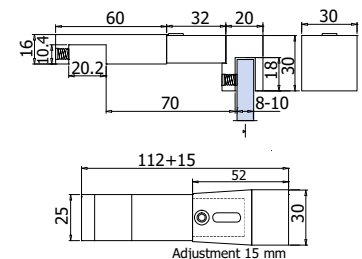
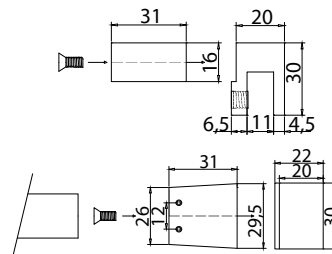
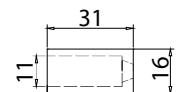
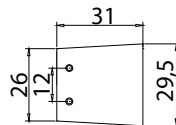
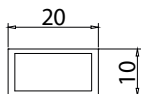

xme397

xme396

xmc023

CR

Cromo lucido
Polished chrome
Chrom glänzend

184

NS

Nickel satinato
Satin nickel
Ähnlich Edelstahl matt

BARRE DI SUPPORTO TONDE

ROUND SUPPORT BARS / RUNDE STABILISATIONSSTANGEN



B-189

- Barra di fissaggio vetro/soffitto.
- Glass to ceiling fixing bar.
- Stabilisationsstange Glas-Decke.

CR

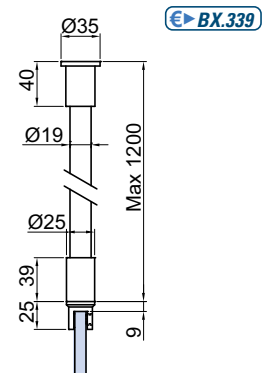
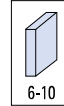

€ BX.339

xfb-086



B-185-S

- Attacco verticale a vetro per tubo Ø 19.
- Vertical glass clamp for Ø 19 mm tube.
- Vertikal Rohrverbinder / Glas für Rohr Ø 19 mm.

CR

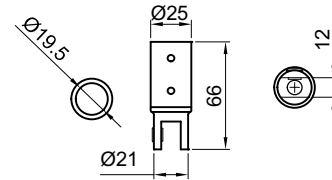

€ BX.338

xfb-089



SEPARÉ

BARRE DI SUPPORTO TONDE ROUND SUPPORT BARS / RUNDE STABILISATIONSSTANGEN



- B-171** €BX.324
- Barra di fissaggio vetro/muro.
 - Glass to wall fixing bar.
 - Stabilisationsstange Glas/Wand.
- CR - NS

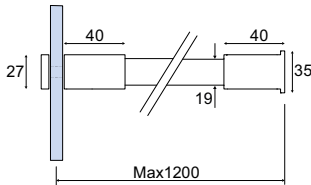
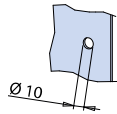

- B-160** €BX.321
- Barra di fissaggio vetro/muro 45°.
 - Glass to wall 45° fixing bar.
 - Stabilisationsstange Glas-Wand 45°.
- CR - NS

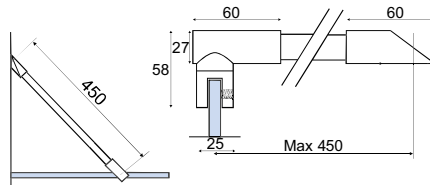

- B-174** €BX.327
- Terminale a muro per barre fermavetro Ø 19 mm.
 - Wall fixing bar end for Ø 19 mm tube.
 - Drehbar Halterungen für Stabilisationsstange.
- CR - NS

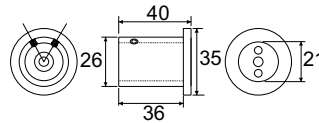

- B-185** €BX.328
- Attacco a vetro per tubo Ø 19 mm.
 - Ottone forgiato.
 - Glass clamp for 19 mm tube. Forged brass.
 - Rohrverbinder / Glas für Rohr Ø 19 mm. Messing geschmiedet.
- CR - NS

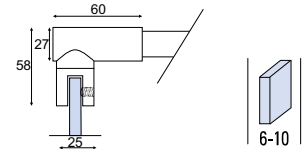

- B-175 (L=1200 mm)** €BX.325
B-176 (L=2000 mm) €BX.326
- Tubo inox lucido Ø 19 mm.
 - Polished stainless steel tube Ø 19 mm.
 - Halterungen für Stabilisationsstange.
- CR - NS

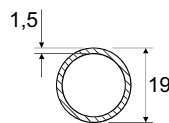

- B-181** €BX.337
- Raccordo vetro-barra a 90°.
 - Connector Glass-bar 90°.
 - Verbinder Glas/Rohr 90°.
- CR - NS

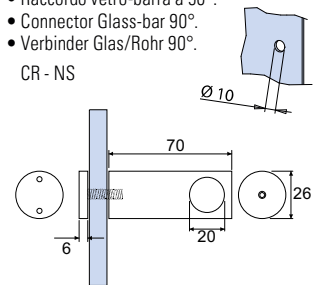

- B-172** €BX.329
- Raccordo di congiunzione a 90° per tubo Ø 19 mm.
 - Forged brass 90° connection joint for 19 mm tube.
 - Stabilisationsstange T-Stück für 19 mm Rohr.
- CR - NS

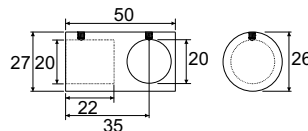

- B-183** €BX.332
- Attacco a vetro foro passante per tubo Ø 19 mm.
 - Glass clamp for 19 mm tube.
 - Rohrverbinder/Glas für Rohr Ø 19 mm.
- CR - NS

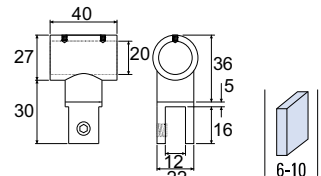

SEPARÉ



B-161 €► **BX.322**
 • Barra di fissaggio vetro/muro 90°.
 • Glass to wall 90° fixing bar.
 • Stabilisationsstange Glas-Wand.
 CR - NS

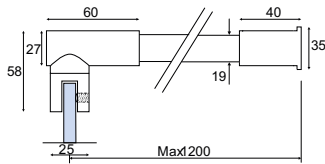

B-162 €► **BX.323**
 • Barra di fissaggio vetro/vetro.
 • Glass to glass fixing bar.
 • Stabilisationsstange Glas-Glas.
 CR - NS

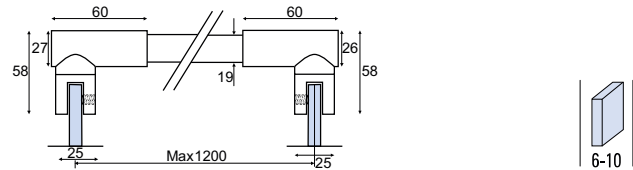

B-167 €► **BX.331**
 • Fermavetro snodata a muro.
 • Ends Forged brass.
 • Halterungen für Stabilisationsstange.
 CR - NS

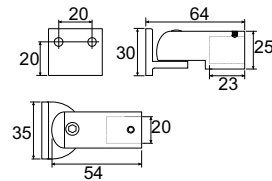

B-166 €► **BX.330**
 • Terminali per barra.
 • Articulated glass to wall bar.
 • Drehbar Messing geschmiedet.
 CR - NS

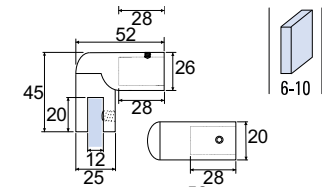

B-164 €► **BX.333**
 • Raccordo a 135° per tubo Ø19 mm.
 • 135° connector for 19 mm tube Forged brass.
 • Rohrverbinder 135° für Rohr Ø 19 mm.
 CR - NS

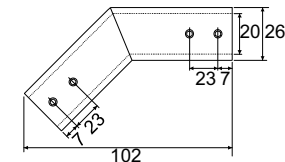

B-165 €► **BX.334**
 • Raccordo a 90° per tubo Ø19 mm.
 • 90° connector for 19 mm tube.
 • Rohrverbinder 90° für Rohr Ø 19 mm.
 CR - NS

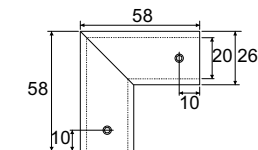

B-184 €► **BX.335**
 • Terminale a muro 45° per barre fermavetro Ø 19 mm.
 • Wall fixing bar 45° end for Ø 19 mm tube.
 • Drehbar Halterungen 45° für Stabilisationsstange.
 CR - NS

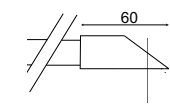

B-173 €► **BX.336**
 • Raccordo regolabile per tubo Ø 19 mm.
 • Adjustable connector for Ø 19 mm tube.
 • Verbinder für 19 mm Rohr Verstellbar.
 CR - NS

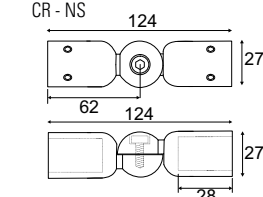

CR
 Cromo lucido
 Polished chrome
 Chrom glänzend

NS
 Nickel satinato
 Satin nickel
 Ähnlich Edelstahl matt

