

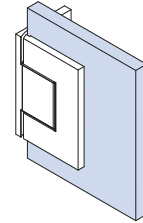
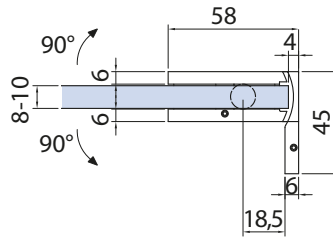
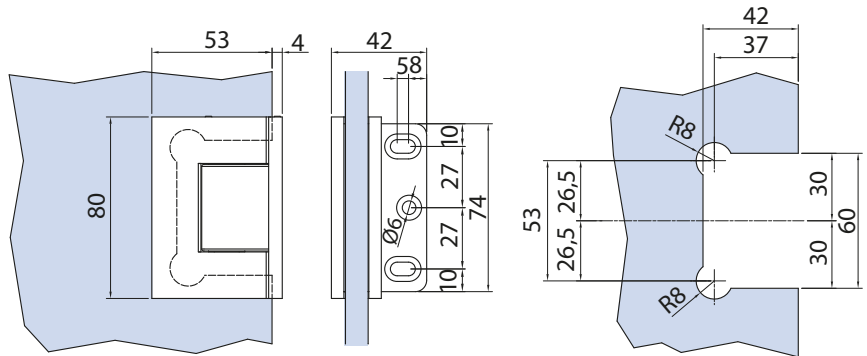

MORSETTI COORDINATI ▶ 191
COORDINATED CLAMPS
KOORDINIERTE KLEMMEN

B-741

- Cerniera a scatto vetro muro regolabile posizione "0", senza viti a vista. Materiale: Zama.
 - Glass to wall double action clicking hinge, no visible screws. "0" position adjustable. Material: Zamak.
 - Pendeltürband Glas-Wand ohne sichtbare Schrauben, mit verstellbarer Nulllagenstellung. Material: Zamak.
- CR - NS - NO

 LAVORAZIONE VETRO
 GLASS PREPARATION
 GLASBEARBEITUNG

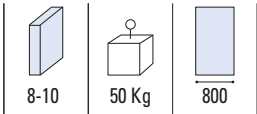
xme708a



CERNIERE

B-742

- Cerniera a scatto regolabile vetro/vetro senza viti a vista. Materiale: Zama.
 - Adjustable glass/glass clicking hinge, no visible screws. Material: Zamak.
 - Pendeltürband Glas-Glas ohne sichtbare Schrauben, mit verstellbarer Nulllagenstellung. Material: Zamak.
- CR - NS - NO

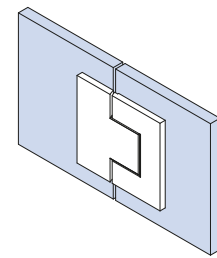
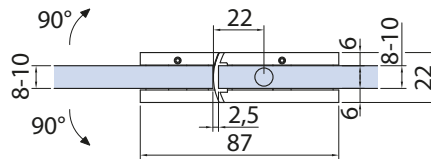
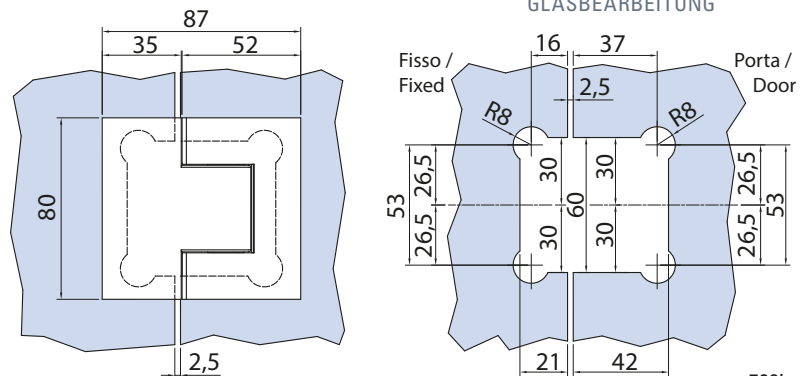
 LAVORAZIONE VETRO
 GLASS PREPARATION
 GLASBEARBEITUNG

xme708b

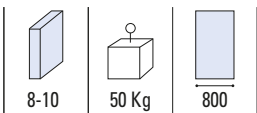
CR
 Cromo lucido
 Polished chrome
 Chrom glänzend

NS
 Nickel satinato
 Satin nickel
 Ähnlich Edelstahl matt

NO
 Nero opaco
 Matt black
 Matt schwarz

CERNIERE A SCATTO **CLICKING HINGES / SELBSTSCHLIESSENDE BÄNDER**

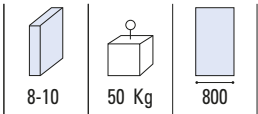
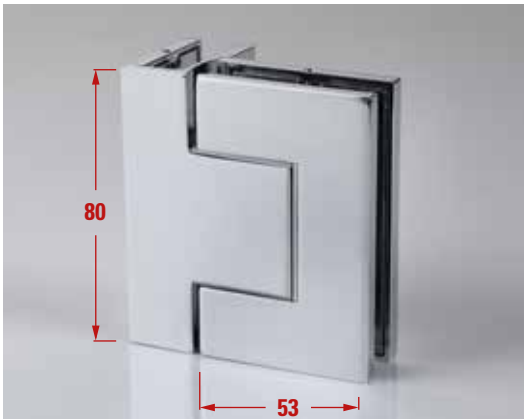

CERNIERE

MORSETTI COORDINATI ▶ 191
COORDINATED CLAMPS
KOORDINIERTE KLEMMEN

B-743

- Cerniera a scatto regolabile vetro/vetro 90°, senza viti a vista. Materiale: Zama.
- Adjustable 90° glass to glass double action clicking hinge, no visible screws. Material: Zamak.
- Pendeltürband Glas-Glas 90°, mit verstellbarer Nulllagenstellung ohne sichtbare Schrauben. Material: Zamak.

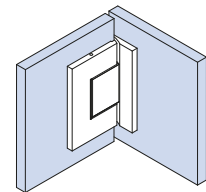
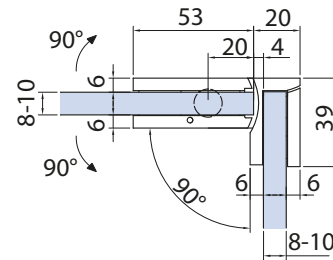
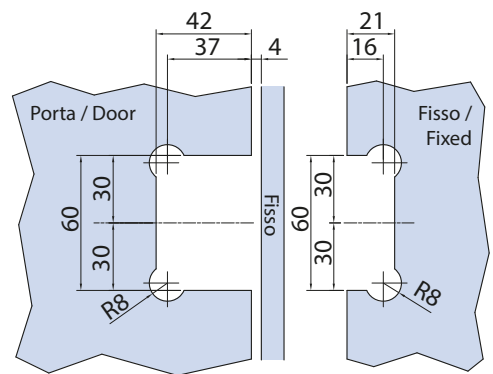
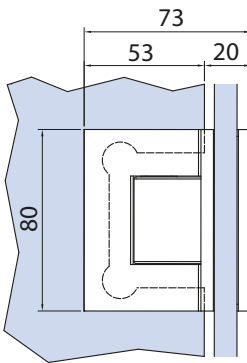
CR - NS - NO



 LAVORAZIONE VETRO
 GLASS PREPARATION
 GLASBEARBEITUNG

xme708c

B-746

- Morsetto angolare 39x39mm vetro-muro 90°
- Glass to wall 39x39mm angular clamp
- Winkelverbinder 39x39mm Glas-Wand

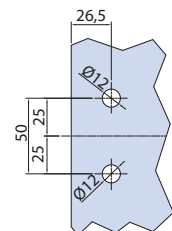
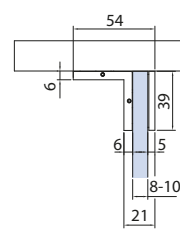
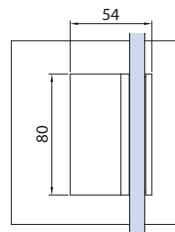
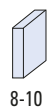
CR - NS - NO

 LAVORAZIONE VETRO
 GLASS PREPARATION
 GLASBEARBEITUNG

xme708d

B-746-V

- Morsetto angolare 39x39mm vetro-vetro 90°
- Glass to glass 39x39mm angular clamp
- Winkelverbinder 39x39mm Glas-Glas

CR - NS - NO

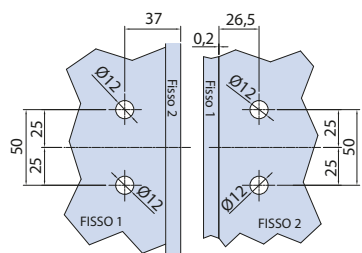
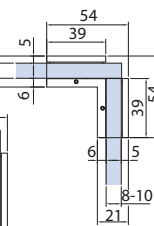
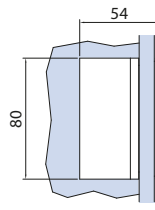
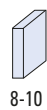
 LAVORAZIONE VETRO
 GLASS PREPARATION
 GLASBEARBEITUNG

xme708e

CR
 Cromo lucido
 Polished chrome
 Chrom glänzend

NS
 Nickel satinato
 Satin nickel
 Ähnlich Edelstahl matt

NO
 Nero opaco
 Matt black
 Matt schwarz