

DISTANZIALI REGOLABILI QUADRI \square 44 / 52 mm

SQUARE ADJUSTABLE POINT FITTINGS \square 44 / 52 mm / ECKIGE VERSTELLBARE PUNKTHALTERUNGEN \square 44 / 52 mm





UNI_{11678:2017}



DRQ-040 40-50

IX / IL
Materiale / Material / Material:
Inox AISI 316

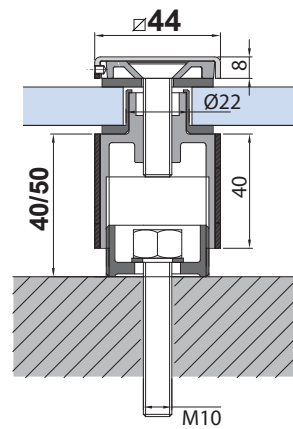
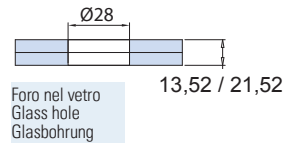

Patent Pending

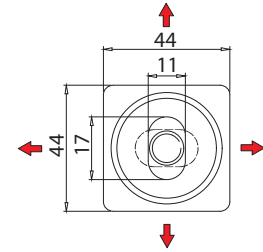

Incluso / Included / Inkl.
M10x80
Art. T-10x80

xme607c



DRQ-048 40-50

IX
Materiale / Material / Material:
Inox AISI 316

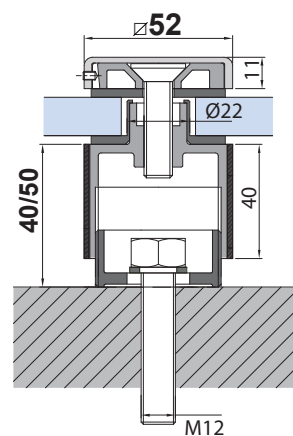
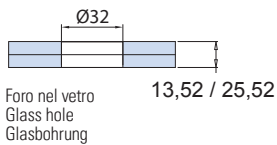

Patent Pending

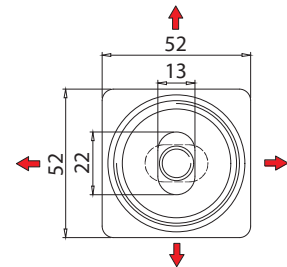

Incluso / Included / Inkl.
M12x80
Art. T-12x80

xme607c

- Regolazione in profondità con vetro montato.
- Depth adjustment with installed glass.
- Tiefeeinstellung mit eingebautem Glas.

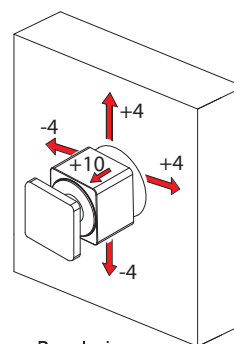
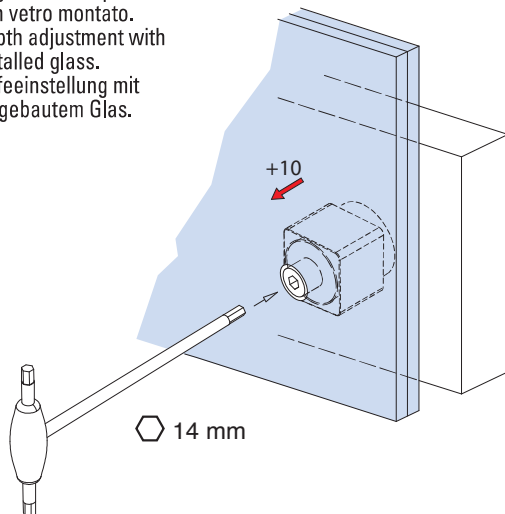

- Regolazione
- Adjustment
- Einstellung

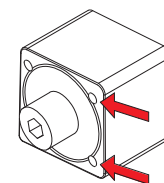

- Sistema che permette l'allineamento del corpo quadrato in qualsiasi posizione
- System that allows the alignment of the square body in any position
- System, das die Ausrichtung des quadratischen Körpers in jeder Position ermöglicht