



BX-5000 TINY

LA DOCCIA INVISIBILE

BX-5000 è il sistema per box doccia semplice e veloce.
Semplice e veloce nel montaggio grazie all'assenza di lavorazioni nel vetro.
Semplice e veloce da pulire con la possibilità di sgancio nella guida inferiore.

FUNZIONALITÀ PERFETTA E GRANDE IMPATTO ESTETICO.

- THE INVISIBLE SHOWER ENCLOSURE
- BX-5000 is a sliding shower enclosure without glass preparation and with optional soft-close closing system, easy and quickly to install. Release door function for easy cleaning.
- FUNCTIONALITY MEETS DESIGN.
- Unsichtbare Duschkabine
- Bx-5000, die Duschkabine ohne Glasbearbeitung, mit optionalem Dämpfung System, einfache und schnelle Montage. Die auslösbare Bodenführung erleichtert das Reinigen.
- Funktionalität trifft auf Design.

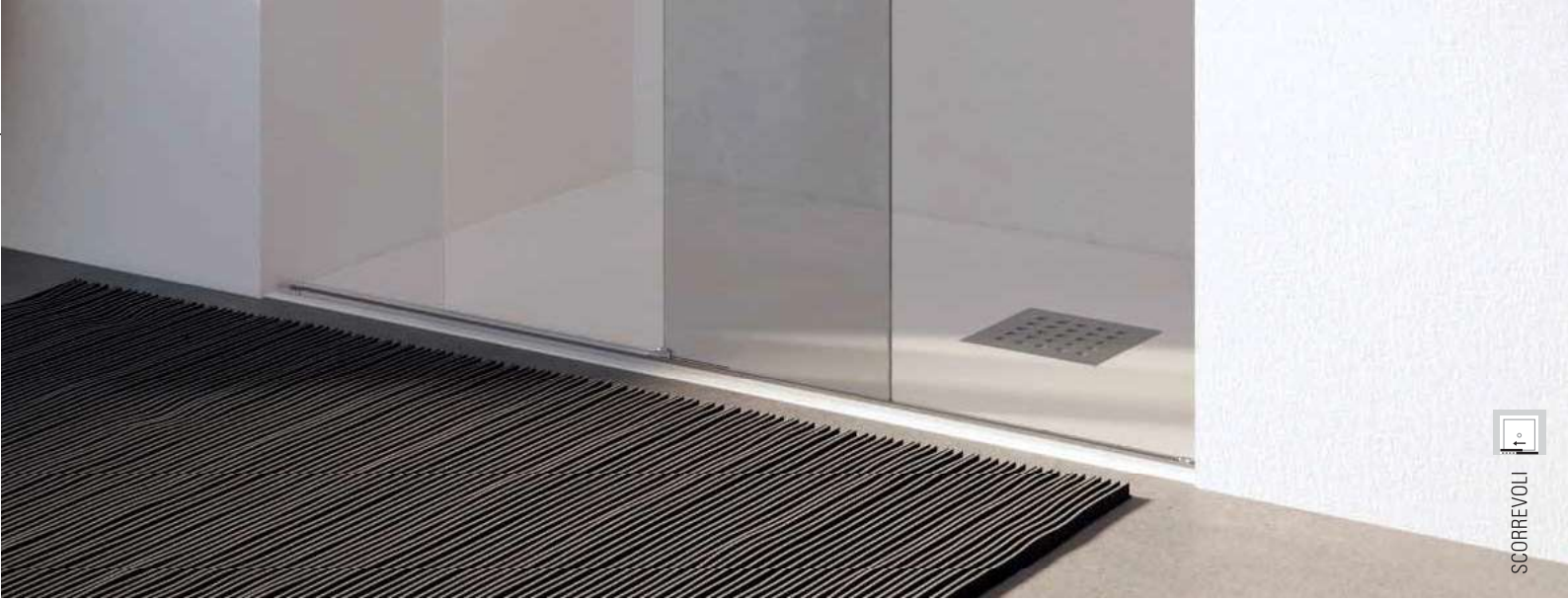

PLUS

- BINARIO ALTO SOLO 40 MM
- MINIMAL E SEMPLICE DA MONTARE
- PINZE REGOLABILI IN ALTEZZA +/- 2,5 MM
- VETRO FISSO INGLOBATO NEL BINARIO
- POSSIBILITÀ DI SOFT-CLOSE SIA IN APERTURA CHE IN CHIUSURA
- DISTANZA TRA VETRO FISSO E MOBILE DI 11 MM
- POSSIBILITÀ DI SGANCIARE LA GUIDA INFERIORE PER UNA PERFETTA PULIZIA

- Rail only 40 mm high
- Minimal and easy to assemble
- Adjustable clamp height +/- 2,5 mm
- Fixed glass enclosed in the rail
- Possible soft-close in both opening and closure
- Only 11mm gap between panels
- Quick release door function for easy cleaning

- Schienenhöhe nur 40 mm
- Einfach und leicht zu montieren
- Höhenverstellbare Laufwagen +/- 2,5 mm
- Festes Glas in die Schiene eingebaut
- Soft-close beidseitig beim öffnen und schließen möglich
- Nur 11 mm Abstand zwischen den Glasscheiben
- Die auslösbare Bodenführung erleichtert das Reinigen

BX-5000 TINY (OPTIONAL SOFT-CLOSE)

NEW



SCORREVOLI



- Sistema scorrevole per box doccia disponibile per versioni in angolo, lineare e in nicchia.
Possibilità di regolazione tramite ruota $\pm 2,5$ mm. Optional soft-close
- Sliding system for shower box, available for corners, single doors or for niche installations. Adjustment of carrying wheels $\pm 2,5$ mm. Optional soft-close
- Schiebetürsystem für Duschkabine, lieferbar für Eck-, Linear und Nischenduschen. Höheneinstellung der Räder $\pm 2,5$ mm. Optional soft-close



SCORREVOLI

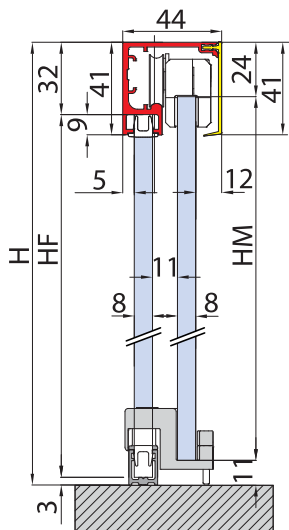
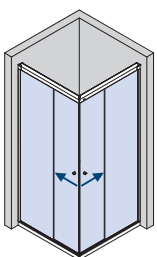
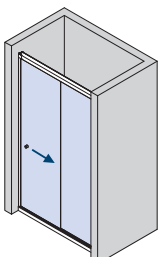
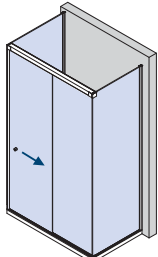
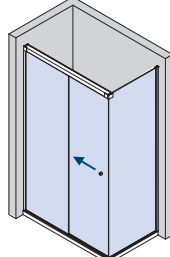
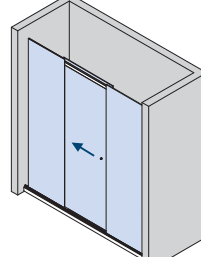
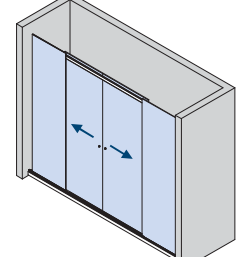

SET 1

SET 2

SET 3

SET 4

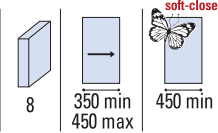
SET 5

SET 6

BX-5000 SET 1

L = 1000 x 1000 mm

DOCCIA IN ANGOLO / CORNER SHOWER / ECKDUSCHE

MY METALGLAS



FINITURE
FINISHING - OBERFLÄCHEN:
CR - NO - IX - BI - OR ▶ 22

COMPONENTI / COMPONENTS / EINZELTEILE

- BX-5000-C10 (2x)
- BX-5000-C30 (4x)
- BX-5000-C90 SX (1x)
BX-5000-C90 DX (1x)
- BX-5000-C20 (1x)
- BX-3150 (2x)
- BX-5006 (2x) **OPTIONAL SOFT-CLOSE**
- OPTIONAL** (1x)

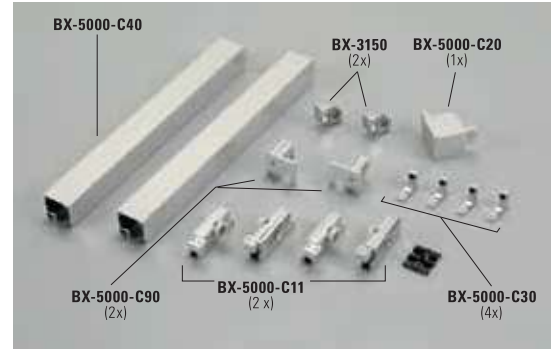
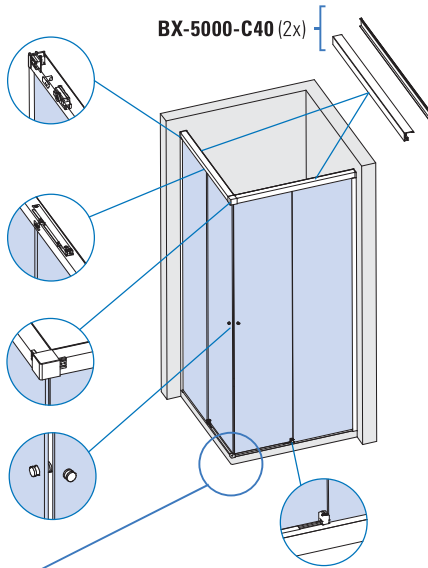

CARATTERISTICHE COMPONENTI /
FEATURES COMPONENTS /
EIGENSCHAFTEN EINZELTEILE ▶ 58

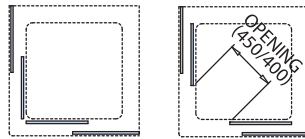
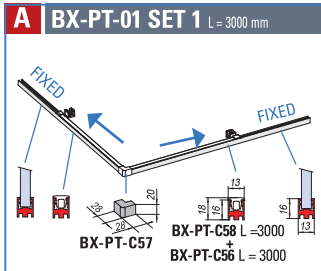

PROFILI A TERRA / FLOOR PROFILES / BODENPROFILE ▶ 106

xme628a

BX-5000 SET 2

L = 1500 mm / L = 3000 mm

DOCCIA IN NICCHIA / NICHE SHOWER / NISCHENDUSCHE

MY METALGLAS

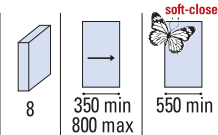

FINITURE
FINISHING - OBERFLÄCHEN:
CR - NO - IX - BI - OR ▶ 22

COMPONENTI / COMPONENTS / EINZELTEILE

- BX-5000-C10 (1x)
- BX-5000-C30 (2x)
- BX-5000-C90 SX (1x)
BX-5000-C90 DX (1x)
- BX-3150 (1x)
- BX-5006 (1x) **OPTIONAL SOFT-CLOSE**
- OPTIONAL** (1x)

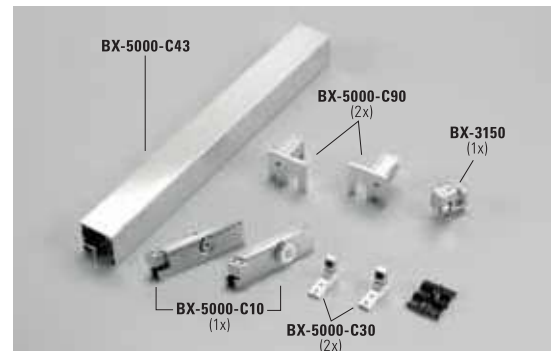
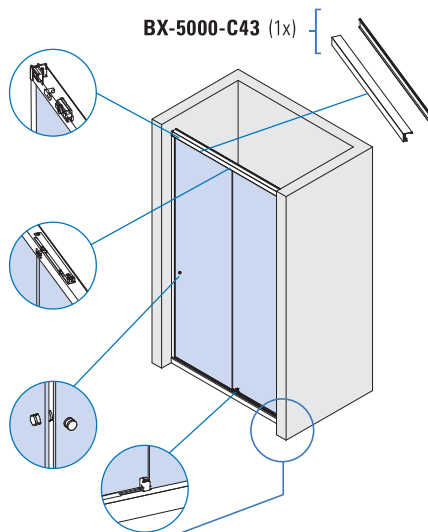

CARATTERISTICHE COMPONENTI /
FEATURES COMPONENTS /
EIGENSCHAFTEN EINZELTEILE ▶ 58

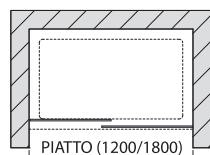
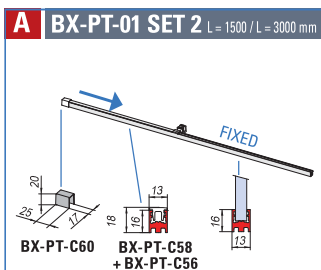

PROFILI A TERRA / FLOOR PROFILES / BODENPROFILE ▶ 106

xme628a

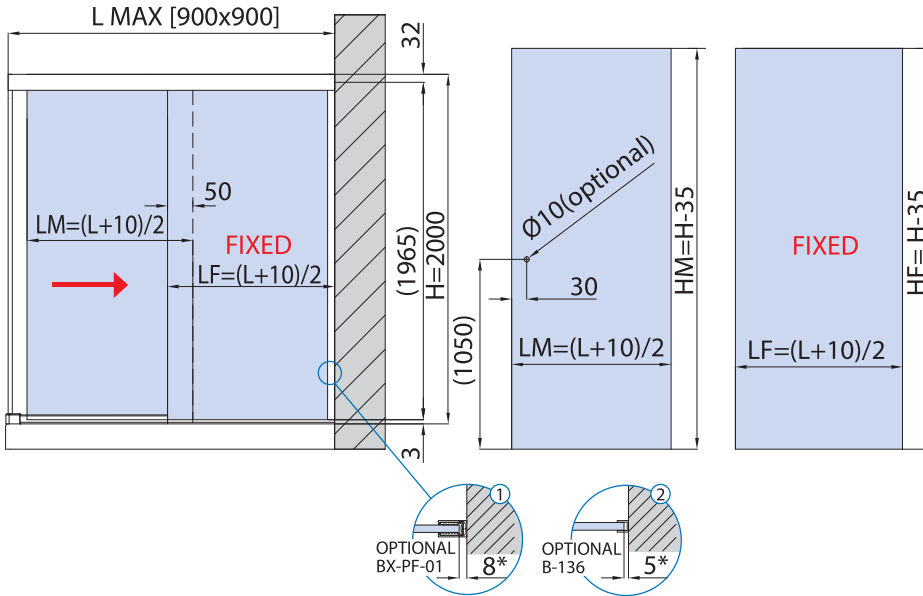
LAVORAZIONE VETRO / GLASS PREPARATION / GLASBEARBEITUNG

CALCOLO VETRO / CALCULATION GLASS / GLASBERECHNUNG

PIATTO - SHOWER TRAY - DUSCHTASSE (L max) = 900 x 900 mm

$$LM = (L+10) / 2$$

$$LF = (L+10) / 2 - * \textcircled{1} / * \textcircled{2} \text{ (aria variabile / clearance / Spaltmaß)}$$

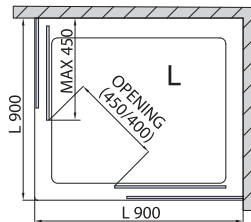
$$HM = H - 35 \text{ (1965)}$$

PROFILI A TERRA / FLOOR PROFILES / BODENPROFILE ▶ 106
A BX-PT-01 STANDARD HF = H - 35 = 1965 mm

xme628b

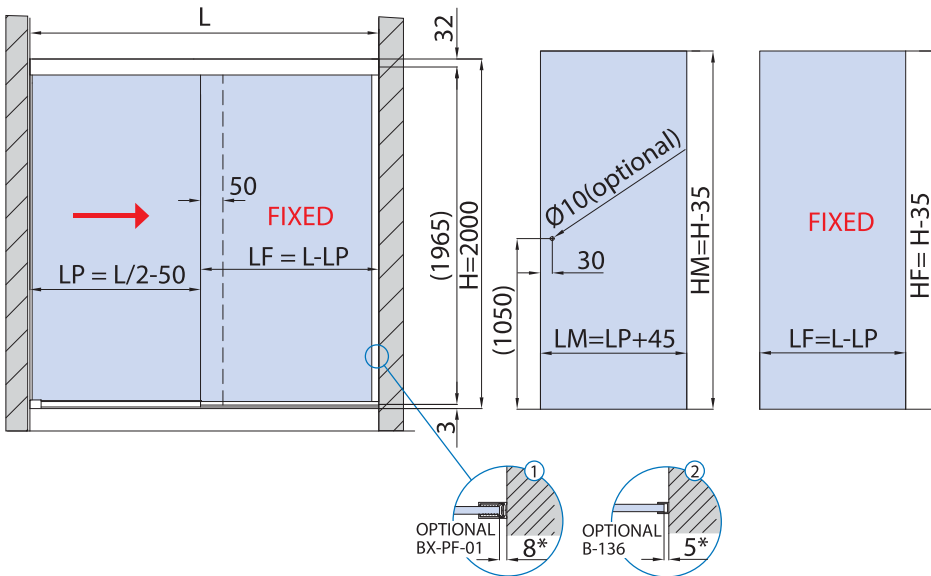
CALCOLO VETRO / CALCULATION GLASS / GLASBERECHNUNG

L = PIATTO - SHOWER TRAY - DUSCHTASSE

$$LP = L / 2 - 50$$

$$LM = LP + 45$$

$$LF = L - LP - * \textcircled{1} / * \textcircled{2} \text{ (aria variabile / clearance / Spaltmaß)}$$

$$HM = H - 35 \text{ (1965)}$$

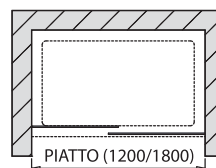
PROFILI A TERRA / FLOOR PROFILES / BODENPROFILE ▶ 106
A BX-PT-01 STANDARD HF = H - 35 = 1965 mm

xme628b

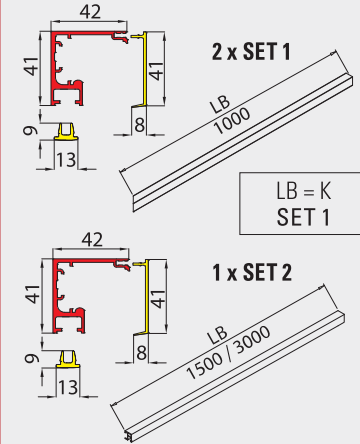
SET 1 / SET 2
DA TAGLIARE / ADJUST THE LENGTH / BELIEBIG KÜRZBAR ✂

- Regolazione ruota ± 2,5 mm.
- Adjustment ± 2,5 mm.
- Verstellung ± 2,5 mm.

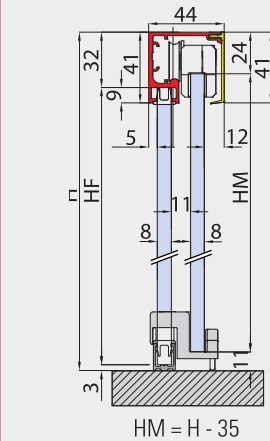

 HF = H - 35
 solo per / only for / nur für
A BX-PT-01
OPTIONAL

L	LP	LM	LF	HM	HF	H
Piatto Shower tray Duschtasse	Passaggio luce Clear opening width Lichte Durchgangsbreite	Larghezza vetro mobile Sliding glass width Schiebeflügel Breite	Larghezza vetro fisso Side fixed glass width Seitenteil Breite	Altezza vetro mobile Sliding glass height Schiebeflügel Höhe	Altezza vetro fisso Side fixed glass height Seitenteil Höhe	Altezza doccia Shower height Duschkabine Höhe

BX-5000 SET 3

L = 1500 mm / L = 3000 mm
DOCCIA A U / U SHOWER / U DUSCHE

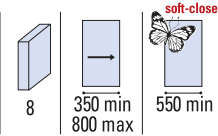
MY METALGLAS



FINITURE
FINISHING - OBERFLÄCHEN:
CR - NO - IX - BI - OR ▶ 22

COMPONENTI / COMPONENTS / EINZELTEILE

BX-5000-C10 (1x)

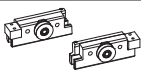

BX-5000-C30 (2x)



BX-5000-C90 SX (1x)



BX-5000-C90 DX (1x)



BX-5000-C81 SX (1x)



BX-5000-C81 DX (1x)



BX-3150 (1x)



BX-5006 (1x)



OPTIONAL
SOFT-CLOSE



OPTIONAL (1x)

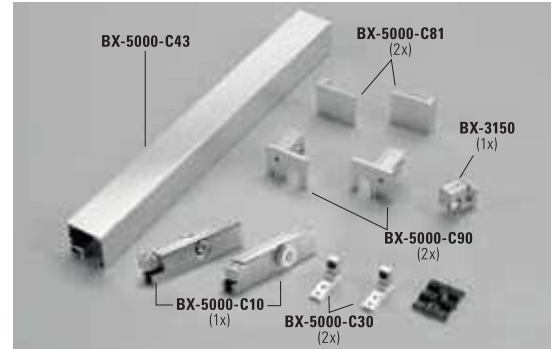
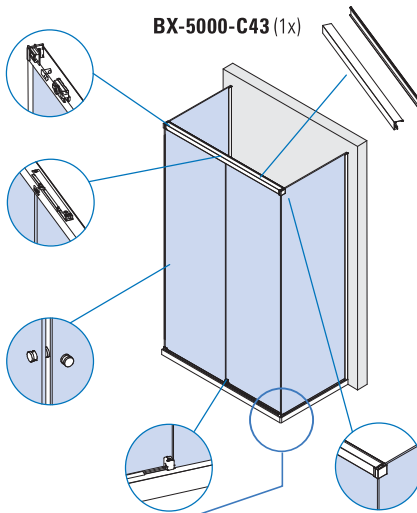

CARATTERISTICHE COMPONENTI /
FEATURES COMPONENTS /
EIGENSCHAFTEN EINZELTEILE ▶ 58

A BX-PT-01 SET 3 L = 1500 / L = 3000 mm

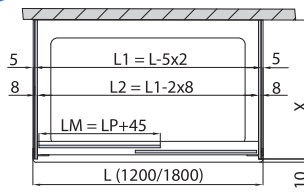
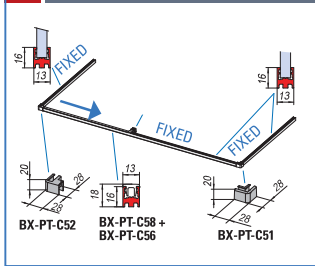

PROFILI A TERRA / FLOOR PROFILES / BODENPROFILE ▶ 106

xme628a

BX-5000 SET 4

L = 1500 mm / L = 3000 mm
DOCCIA CON SPALLA IN VETRO / CORNER SHOWER WITH 2
FIXED PANEL / ECKDUSCHE MIT 2 FESTSTEHENDEN GLASTAFELN

MY METALGLAS

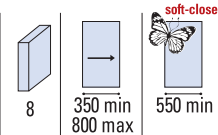

FINITURE
FINISHING - OBERFLÄCHEN:
CR - NO - IX - BI - OR ▶ 22

COMPONENTI / COMPONENTS / EINZELTEILE

BX-5000-C10 (1x)

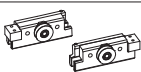

BX-5000-C30 (2x)



BX-5000-C90 SX (1x)



BX-5000-C90 DX (1x)



BX-5000-C81 SX/DX (1x)



BX-3150 (1x)



BX-5006 (1x)



OPTIONAL
SOFT-CLOSE



OPTIONAL (1x)

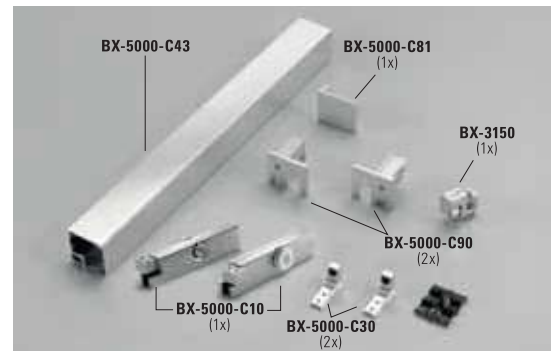
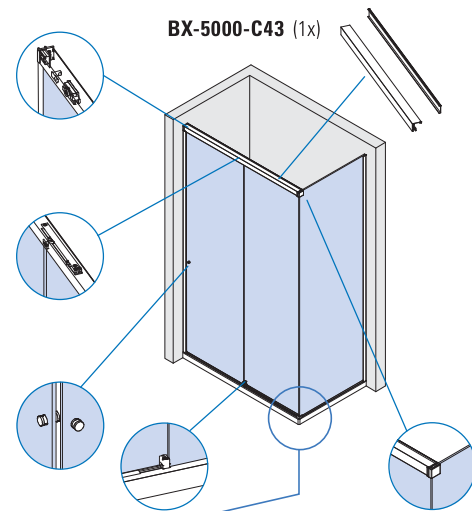

CARATTERISTICHE COMPONENTI /
FEATURES COMPONENTS /
EIGENSCHAFTEN EINZELTEILE ▶ 58

A BX-PT-01 SET 4 L = 1500 / L = 3000 mm

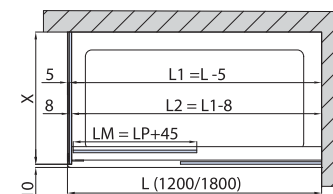
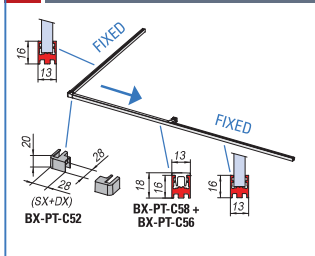

PROFILI A TERRA / FLOOR PROFILES / BODENPROFILE ▶ 106

xme628a

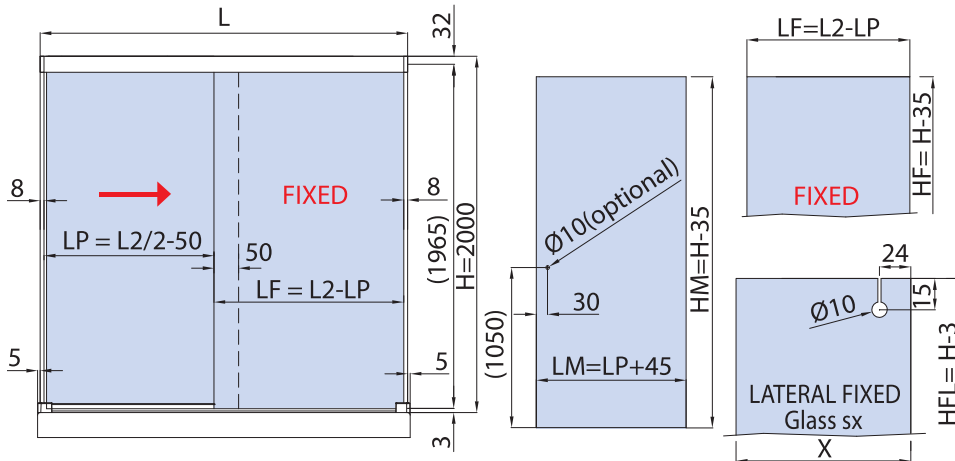
LAVORAZIONE VETRO / GLASS PREPARATION / GLASBEARBEITUNG

CALCOLO VETRO / CALCULATION GLASS / GLASBERECHNUNG

L = PIATTO - SHOWER TRAY - DUSCHTASSE
 L1 = (L) - 5 x 2
 L2 = L1 - 2 x 8
 LP = L2 / 2 - 50
 LM = LP + 45
 LF = (L2 - LP) - * ① / * ② (aria variabile / clearance / Spaltmaß)
 X = CALCOLARE / CALCULATE / BERECHNEN
 HM = H - 35 (1965)

PROFILI A TERRA / FLOOR PROFILES / BODENPROFILE ▶ 106

A BX-PT-01 STANDARD HF = H - 35 = 1965 mm HFL = H - 3

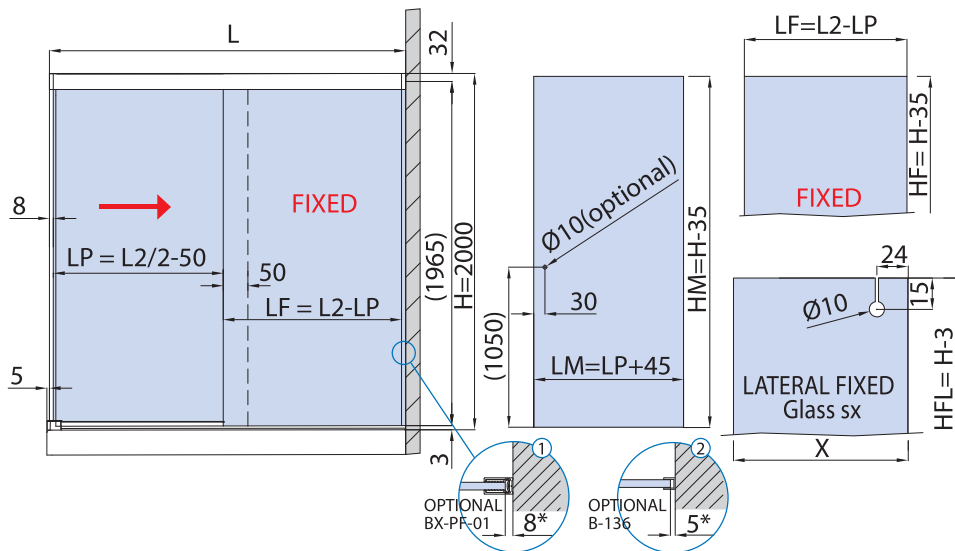
xme628c

CALCOLO VETRO / CALCULATION GLASS / GLASBERECHNUNG

L = PIATTO - SHOWER TRAY - DUSCHTASSE
 L1 = (L) - 5
 L2 = L1 - 8
 LP = L2 / 2 - 50
 LM = LP + 45
 LF = (L2 - LP) - * ① / * ② (aria variabile / clearance / Spaltmaß)
 X = CALCOLARE / CALCULATE / BERECHNEN
 HM = H - 35 (1965)

PROFILI A TERRA / FLOOR PROFILES / BODENPROFILE ▶ 106

A BX-PT-01 STANDARD HF = H - 35 = 1965 mm HFL = H - 3

xme628c

SET 3 / SET 4

DA TAGLIARE / ADJUST THE LENGTH / BELIEBIG KÜRZBAR ✂

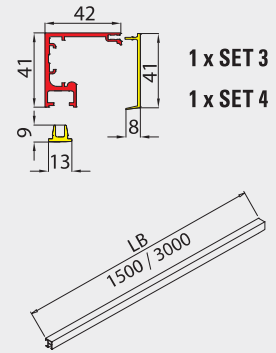

- Regolazione ruota ± 2,5 mm.
- Adjustment ± 2,5 mm.
- Verstellung ± 2,5 mm.

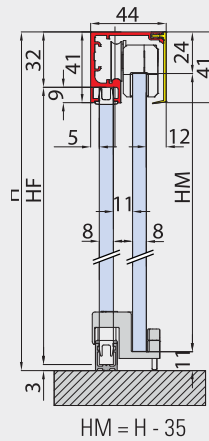

HF = H - 35
solo per / only for / nur für **A BX-PT-01**

OPTIONAL

L	LP	LM	LF	HM	HF	H	HFL
Piatto Shower tray Duschtasse	Passaggio luce Clear opening width Lichte Durchgangsbreite	Larghezza vetro mobile Sliding glass width Schiebeflügel Breite	Larghezza vetro fisso Side fixed glass width Seitenteil Breite	Altezza vetro mobile Sliding glass height Schiebeflügel Höhe	Altezza vetro fisso Side fixed glass height Seitenteil Höhe	Altezza doccia Shower height Duschkabine Höhe	Altezza vetro fisso laterale Side fixed glass height Seitenteil (seitlich) Höhe

BX-5000 SET 5

L = 3000 mm
DOCCIA A U / U SHOWER / U DUSCHE

MY METALGLAS

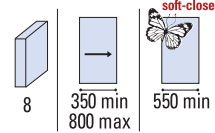

FINITURE
FINISHING - OBERFLÄCHEN:
CR - NO - IX - BI - OR ▶ 22

COMPONENTI / COMPONENTS / EINZELTEILE

BX-5000-C10 (1x)



BX-5000-C30 (2x)



BX-5000-C90 SX (1x)
BX-5000-C90 DX (1x)



BX-3150 (1x)



BX-5006 (1x)
OPTIONAL
SOFT-CLOSE



OPTIONAL (1x)

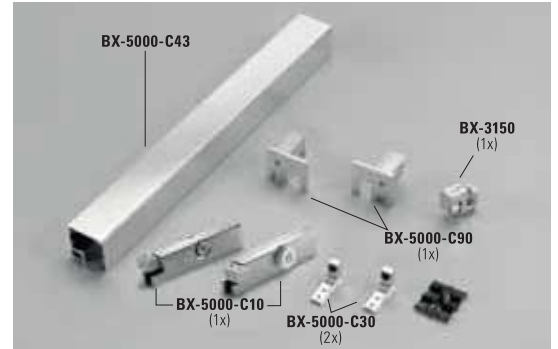
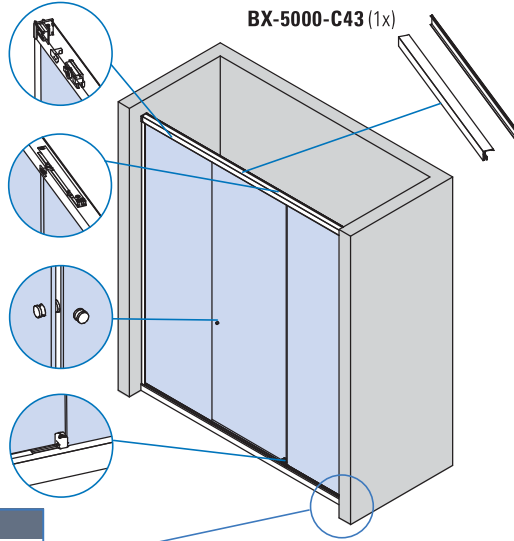

CARATTERISTICHE COMPONENTI /
FEATURES COMPONENTS /
EIGENSCHAFTEN EINZELTEILE ▶ 58

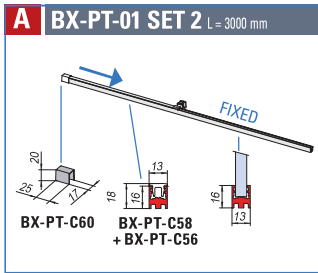

PROFILI A TERRA / FLOOR PROFILES / BODENPROFILE ▶ 106

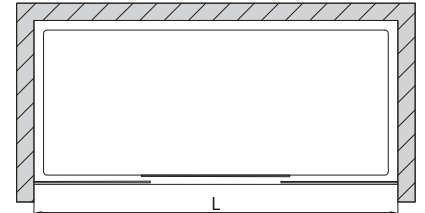

xme628e

BX-5000 SET 6

L = 3000 mm
DOCCIA CON SPALLA IN VETRO / CORNER SHOWER WITH 2
FIXED PANEL / ECKDUSCHE MIT 2 FESTSTEHENDEN GLASTAFELN

MY METALGLAS

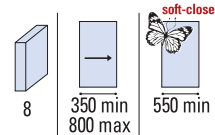

FINITURE
FINISHING - OBERFLÄCHEN:
CR - NO - IX - BI - OR ▶ 22

COMPONENTI / COMPONENTS / EINZELTEILE

BX-5000-C10 (2x)

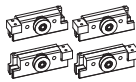

BX-5000-C30 (4x)



BX-5000-C90 SX (1x)
BX-5000-C90 DX (1x)



BX-3150 (2x)



BX-5006 (2x)
OPTIONAL
SOFT-CLOSE



OPTIONAL (2x)

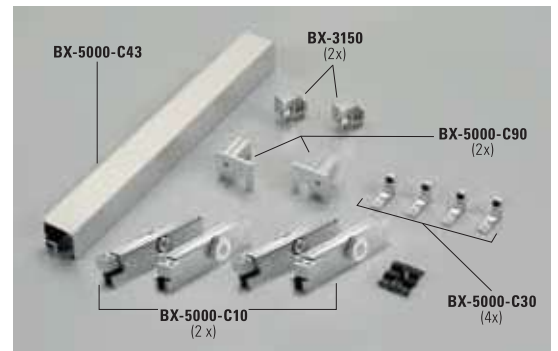
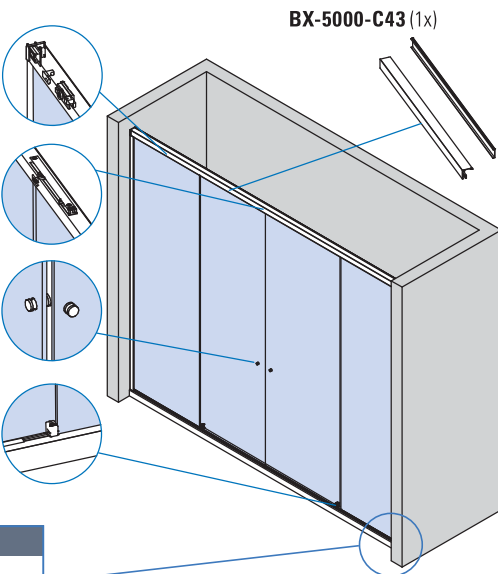

CARATTERISTICHE COMPONENTI /
FEATURES COMPONENTS /
EIGENSCHAFTEN EINZELTEILE ▶ 58

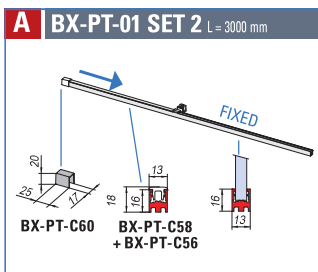

PROFILI A TERRA / FLOOR PROFILES / BODENPROFILE ▶ 106

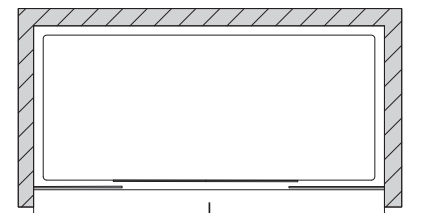

xme628f

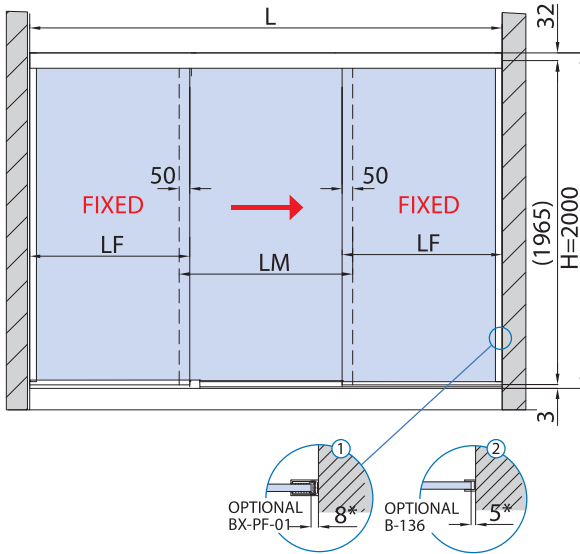
LAVORAZIONE VETRO / GLASS PREPARATION / GLASBEARBEITUNG

CALCOLO VETRO / CALCULATION GLASS / GLASBERECHNUNG

L = PIATTO - SHOWER TRAY - DUSCHASSE
 $LM = LF = (L + 100) / 3$
 $LF = LF - * (1) / * (2)$
 (aria variabile / clearance / Spaltmaß)
 $HM = H - 35 = 1965 \text{ mm}$

PROFILI A TERRA / FLOOR PROFILES / BODENPROFILE ▶ 106

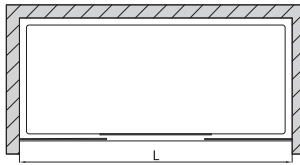
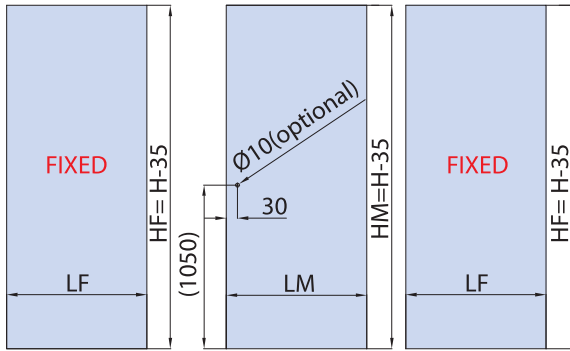
▲ BX-PT-C58
 STANDARD HF = H - 35 = 1965 mm

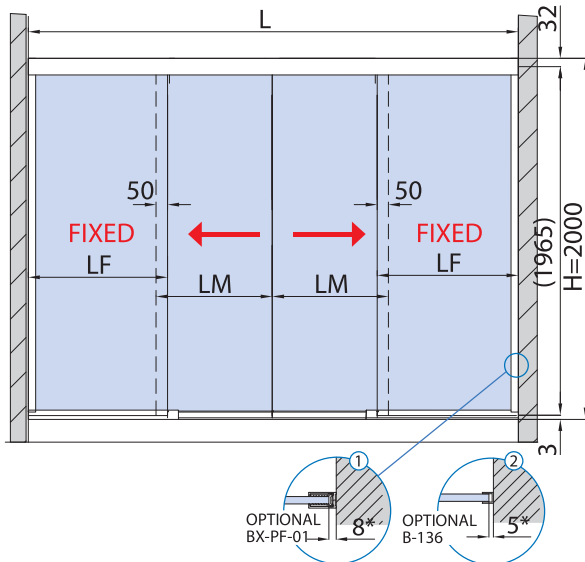

xme628e

CALCOLO VETRO / CALCULATION GLASS / GLASBERECHNUNG

L = PIATTO - SHOWER TRAY - DUSCHASSE
 $LM = LF = (L + 100) / 4$
 $LF = LF - * (1) / * (2)$
 (aria variabile / clearance / Spaltmaß)
 $HM = H - 35 = 1965 \text{ mm}$

PROFILI A TERRA / FLOOR PROFILES / BODENPROFILE ▶ 106

▲ BX-PT-C58
 STANDARD HF = H - 35 = 1965 mm

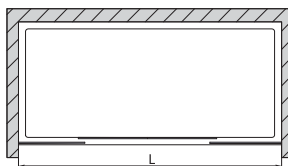
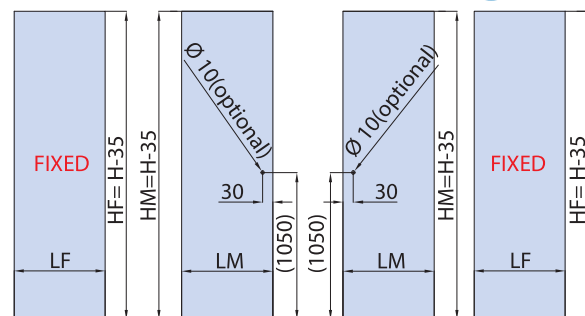

xme628f

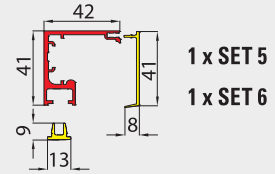
SET 5 / SET 6
DA TAGLIARE / ADJUST THE LENGTH / BELIEBIG KÜRZBAR ✂

1 x SET 5
 1 x SET 6

- Regolazione ruota ± 2,5 mm.
- Adjustment ± 2,5 mm.
- Verstellung ± 2,5 mm.

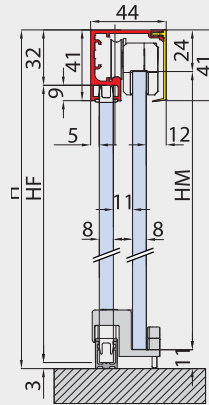
 $HM = H - 35$

HF = H - 35
 solo per / only for / nur für
 ▲ BX-PT-01

OPTIONAL

L	LP	LM	LF	HM	HF	H	HFL
Piatto Shower tray Duschasse	Passaggio luce Clear opening width Lichte Durchgangsbreite	Larghezza vetro mobile Sliding glass width Schiebeflügel Breite	Larghezza vetro fisso Side fixed glass width Seitenteil Breite	Altezza vetro mobile Sliding glass height Schiebeflügel Höhe	Altezza vetro fisso Side fixed glass height Seitenteil Höhe	Altezza doccia Shower height Duschkabine Höhe	Altezza vetro fisso laterale Side fixed glass height Seitenteil (seitlich) Höhe

BX-5000

COMPONENTI / COMPONENTS / EINZELTEILE

SCORREVOLI

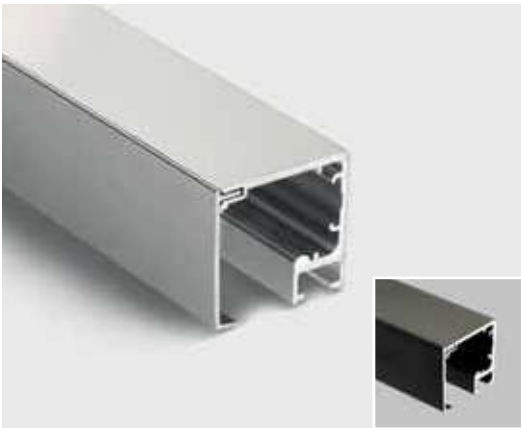

BX-5000-C40/C43

- Binario con veletta, profilo di chiusura per sede vetro fisso BX-4001 incluso
- Track profile with cover, profile for fixed glass section BX-4001 included
- Laufschiene mit Profilabdeckung, Sichtschutzprofil für Seitenteil Sektor BX-4001 enthalten

CR - NO - IX - BI - OR

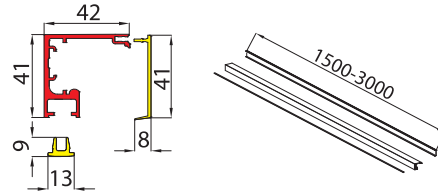

Cod.	Fin. / Fin. / Oberf.
BX-5000-C43-1500 mm	CR / NO / IX / BI / OR
BX-5000-C43-3000 mm	CR / NO / IX / BI / OR
BX-5000-C40-1000 x 1000 mm (2 pcs)	CR / NO / IX / BI / OR

xme628d



BX-5000-C11

- Set composto da 2 carrelli (1 pc DX + 1 pc SX) per set 1
- Set consisting of 2 roller carriers (1 pc right + 1 pc left) for set 1
- Set bestehend aus 2 Klemm-Laufwagen (1 Stk Rechts + 1 Stk Links) für set 1

CR - NO

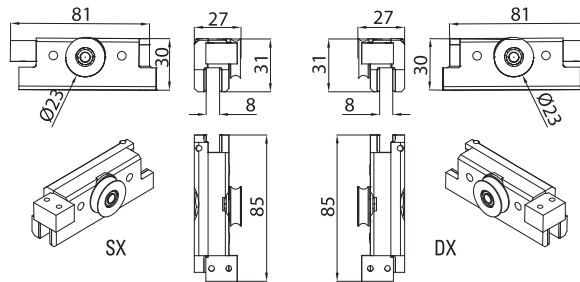

xme632n



BX-5000-C10

- Set composto da 2 carrelli (1 pc DX + 1 pc SX) per set 2 - 3 - 4 - 5 - 6
- Set consisting of 2 roller carriers (1 pc right + 1 pc left) for set 2 - 3 - 4 - 5 - 6
- Set bestehend aus 2 Klemm-Laufwagen (1 Stk Rechts + 1 Stk Links) für set 2 - 3 - 4 - 5 - 6

CR - NO

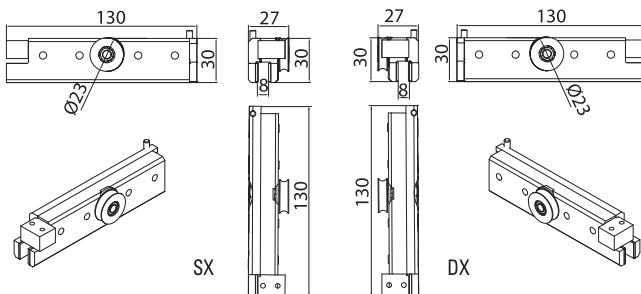

C-374-G1 NEW



BX-5000-C90 DX

- Attacco a parete destro per binario
- Right wall connector for track profile
- Wandhalter rechts für Laufschiene

CR - NO - NS - BI - OR

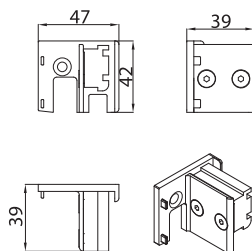

xme628d



BX-5000-C90 SX

- Attacco a parete sinistro per binario
- Left wall connector for track profile
- Wandhalter links für Laufschiene

CR - NO - NS - BI - OR

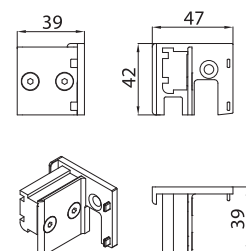

xme628d

BX-5000-C81 DX

- Piastrina destra attacco a vetro per BX-5000-C90
 - Right plate glass connector for BX-5000-C90
 - Platte Glashalter rechts für BX-5000-C90
- CR - NO - NS - BI - OR

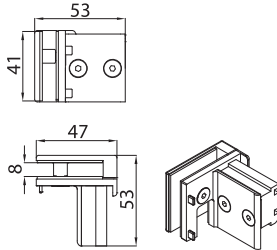

xme628d

BX-5000-C81 SX

- Piastrina sinistra attacco a vetro per BX-5000-C90
 - Left plate glass connector for BX-5000-C90
 - Platte Glashalter links für BX-5000-C90
- CR - NO - NS - BI - OR

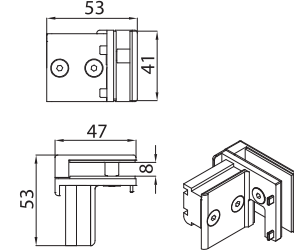

xme628d

BX-5000-C30

- Stopper
- AN

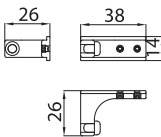

xme628d

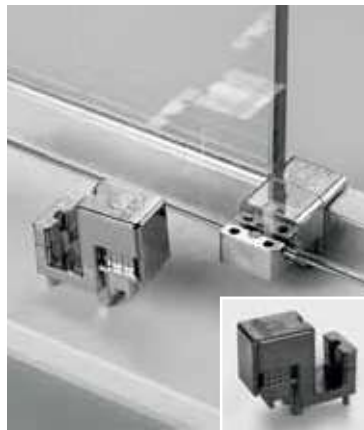
BX-3150

- Guida vetro scorrevole BX-3150 per applicazione con profilo a terra BX-PT-C58 sistema di sgancio della porta per facilitare la pulizia.
 - Floor guide sliding panel BX-3150 for installation with floor profile BX-PT-C58 with quick release door function for easy cleaning.
 - Schiebetür Bodenführung BX-3150 für Montage mit Bodenprofil BX-PT-C58 mit auslosbarem System um das Reinigen zu erleichtern.
- CR - NO - NS - BI - OR

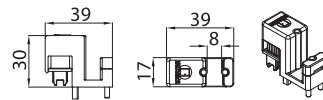

xme628d

BX-5000-C20

- Connettore ad angolo per binario per set 1
 - Corner connector for track profile set 1
 - Winkelverbinder Laufschiene set 1
- CR - NO - NS - BI - OR

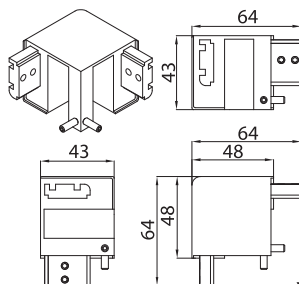

xme628d

BX-5006 Optional SOFT-CLOSE

- Soft-close in apertura e chiusura
- Double acting Soft-close
- Soft-close doppelt Winkende

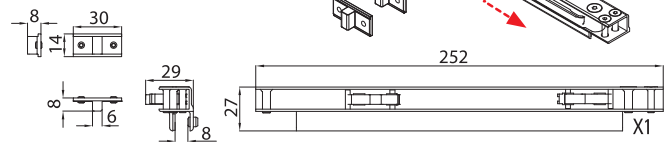

xme628d

BX PT-C58

- Profilo per fissaggio a terra o laterale
- Profile for floor and side installation
- Profil Boden Wand-Montage

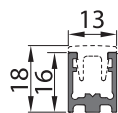
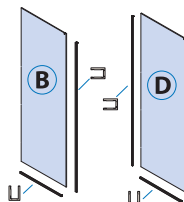

Cod.	Fin./Fin./Fin.
BX-PT-C58-1500 mm	CR - NO - IX - BI - OR
BX-PT-C58-3000 mm	CR - NO - IX - BI - OR

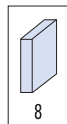
BX PT-C56

- Coperchio per profilo a terra per tratto entrata doccia
- Cover profile for floor profile, shower entry.
- Profilabdeckung Bodenprofil Duscheinstieg

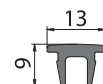

Cod.	Fin./Fin./Fin.
BX-PT-C56-1500 mm	CR - NO - IX - BI - OR
BX-PT-C56-3000 mm	CR - NO - IX - BI - OR

