

LUCE TELESCOPICO

SLIDING COLLECTION

I sistemi telescopici rappresentano la migliore soluzione per dividere o unire gli ambienti senza compromettere praticità, spazio e design.

Telescopic systems are the best solution to divide or join rooms without compromising on practicality, space and design.

Teleskopsysteme stellen die beste Lösung dar, um Umgebungen zu teilen oder miteinander zu verbinden, ohne dabei die Zweckmäßigkeit, den Raum und das Design zu beeinträchtigen.

LUCE TELESCOPICO

SISTEMA TELESCOPICO - TELESCOPIC SYSTEM - TELESKOPSYSTEM

LUCE TELESCOPICO

- 1 Binario a vista o invisibile - Altezza ridotta: 86 mm
 Visible or invisible track profile - Profile height only 86 mm
 Sichtbare oder unsichtbare Laufschiene - Profilhöhe nur 86 mm

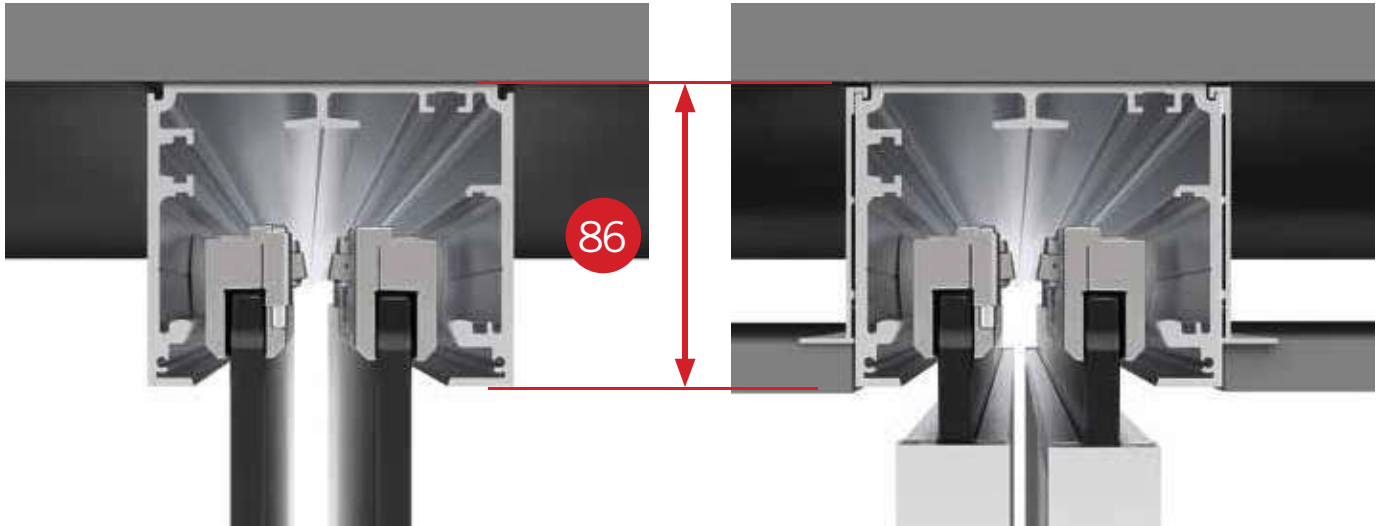

- 2 V-7702
 Regolazione dal basso 6 mm con portata 120 Kg
 Adjustment 6 mm from below. Max door weight 120 Kg
 Einstellung 6 mm von unten. Max Schiebeflügelgewicht 120 Kg



3



- 3 V-7708-70
 Possibilità Soft-close sia in apertura che in chiusura (1 pc + 1 pc)
 Soft-close available in opening and closing (1 pc + 1 pc)
 Soft-close verfügbar für Öffnung und Schließung (1 pc + 1 pc)



- V-7708-100
 Possibilità Soft-close sia in apertura che in chiusura (1 pc + 1 pc)
 Soft-close available in opening and closing (1 pc + 1 pc)
 Soft-close verfügbar für Öffnung und Schließung (1 pc + 1 pc)



4 Possibilità di installare...
Possibility of installing...
Montagem glichkeiten...

... ante intelaiate che si allineano
... aligned framed doors
... aneinandergereihte Rahmentüren



... ante tutto vetro
... frameless glass doors
... Ganzglastüren

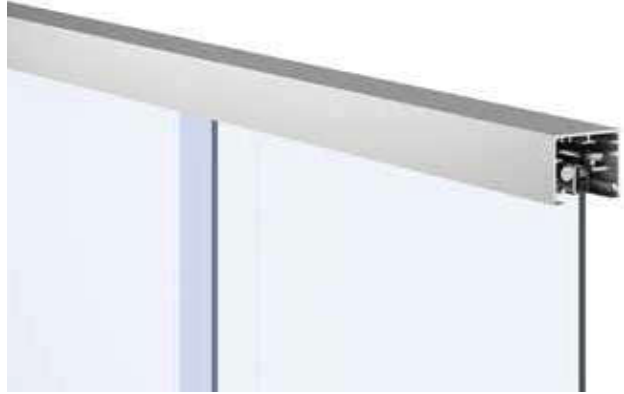

5 Possibilità di scegliere...
Possibility of installing...
Montagem glichkeiten...

Trascinamento Sincro

Sincro dragging system with toothed belt
Sincro Mitnehmer Kit mit Zahnriemen



Anta intelaiata
Framed doors
Rahmentüren



Anta tutto vetro
Frameless glass door
Ganzglastür

Trascinamento meccanico

Mechanical dragging system
Mechanischer Mitnehmer



Anta intelaiata
Framed doors
Rahmentüren



Anta tutto vetro
Frameless glass door
Ganzglastür

LUCE TELESCOPICO (ANTA INTELAIATA - FRAMED PANEL - GERAHMTE T R)

BINARI A VISTA - VISIBLE TRACK PROFILES - SICHTBARE LAUFSCHIENEN

BINARIO 2 VIE TELESCOPICO
TELESCOPIC 2- AYS TRACK PROFILE
TELESKOP 2- EGE-LAUFSCHIENE

A SOFFITTO
CEILING INSTALLATION
DECKENMONTAGE

A PARETE
ALL INSTALLATION
ANDMONTAGE

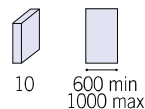

DIV-7700 / DIV-7800

Pagine tecniche - Technical pages - Technische Seiten ▶ 134

SET 1
a soffitto
ceiling / Decke

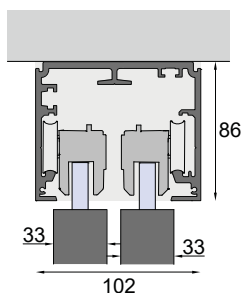

SET 2
a parete
wall / and

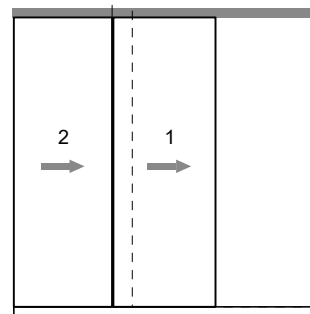
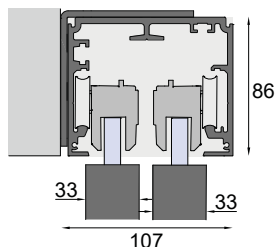

DIV-7700
TRASCINAMENTO MECCANICO
MECHANICAL DRAGGING SYSTEM
MIT MECHANISCHEM MITNEHMER



DIV-7800
TRASCINAMENTO SINCRONICO CON CINGHIA
SINCRO DRAGGING SYSTEM WITH TOOTHED BELT
SINCRO MITNEHMER KIT MIT ZAHNRIEMEN

BINARIO 2 VIE TELESCOPICO CON FISSO
TELESCOPIC 2- AYS TRACK PROFILE WITH FIXED PANEL
TELESKOP 2- EGE-LAUFSCHIENE MIT SEITENTEIL

A SOFFITTO
CEILING INSTALLATION
DECKENMONTAGE

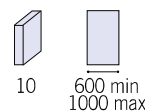

DIV-7703 / DIV-7803

Pagine tecniche - Technical pages - Technische Seiten ▶ 135

SET 1
a soffitto
ceiling / Decke

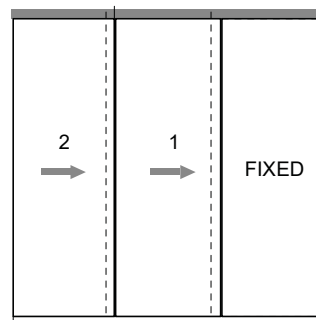
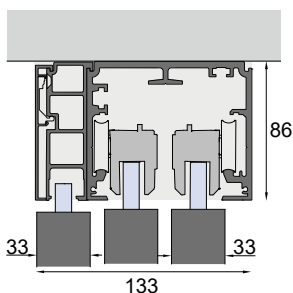

DIV-7703
TRASCINAMENTO MECCANICO
MECHANICAL DRAGGING SYSTEM
MIT MECHANISCHEM MITNEHMER



DIV-7803
TRASCINAMENTO SINCRONICO CON CINGHIA
SINCRO DRAGGING SYSTEM WITH TOOTHED BELT
SINCRO MITNEHMER KIT MIT ZAHNRIEMEN

BINARIO 2 VIE TELESCOPICO INVISIBILE
 TELESCOPIC 2- AYS INVISIBLE TRACK PROFILE
 TELESKOP 2- EGE-UNSICHTBARE LAUFSCHIENE

A SOFFITTO
 CEILING INSTALLATION
 DECKENMONTAGE

A PARETE
 ALL INSTALLATION
 ANDMONTAGE

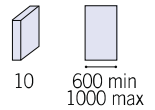

DIV-7700 / DIV-7800 + V-7006-CF2

Pagine tecniche - Technical pages - Technische Seiten ▶ 136

a soffitto
 ceiling / Decke



a parete
 wall / and

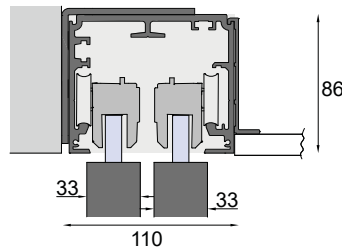
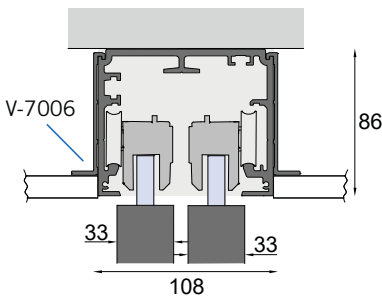
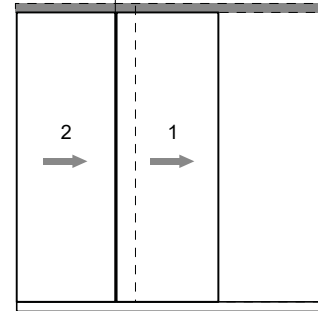

DIV-7700
 TRASCINAMENTO MECCANICO
 MECHANICAL DRAGGING SYSTEM
 MIT MECHANISCHEM MITNEHMER



DIV-7800
 TRASCINAMENTO SINCRON CON CINGHIA
 SINCRON DRAGGING SYSTEM WITH TOOTHED BELT
 SINCRON MITNEHMER KIT MIT ZAHNRIEMEN

BINARIO 2 VIE TELESCOPICO INVISIBILE CON FISSO
 TELESCOPIC 2- AYS INVISIBLE TRACK PROFILE WITH FIXED PANEL
 TELESKOP 2- EGE-UNSICHTBARE LAUFSCHIENE MIT SEITENTEIL

A SOFFITTO
 CEILING INSTALLATION
 DECKENMONTAGE

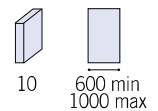

DIV-7713 / DIV-7813 + V-7006-CF2

Pagine tecniche - Technical pages - Technische Seiten ▶ 137

a soffitto
 ceiling / Decke

SET 1

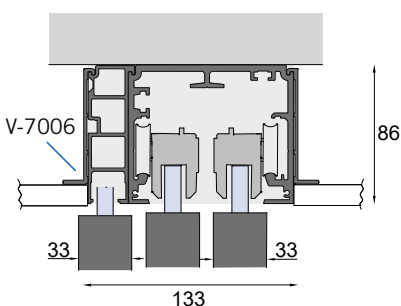
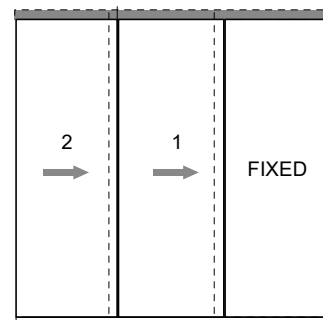

DIV-7713
 TRASCINAMENTO MECCANICO
 MECHANICAL DRAGGING SYSTEM
 MIT MECHANISCHEM MITNEHMER



DIV-7813
 TRASCINAMENTO SINCRON CON CINGHIA
 SINCRON DRAGGING SYSTEM WITH TOOTHED BELT
 SINCRON MITNEHMER KIT MIT ZAHNRIEMEN

LUCE TELESCOPICO

BINARI A VISTA - VISIBLE TRACK PROFILES - SICHTBARE LAUFSCHIENEN

BINARIO 2 VIE TELESCOPICO
TELESCOPIC 2- AYS TRACK PROFILE
TELESKOP 2- EGE-LAUFSCHIENE

A SOFFITTO
CEILING INSTALLATION
DECKENMONTAGE

A PARETE
ALL INSTALLATION
ANDMONTAGE

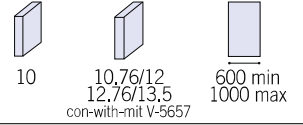

V-7700 / V-7800

Pagine tecniche - Technical pages - Technische Seiten ► 138

a soffitto
ceiling / Decke



a parete
wall / and

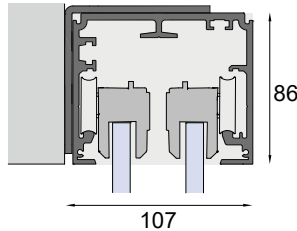
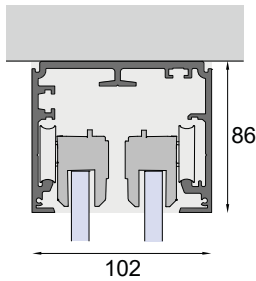
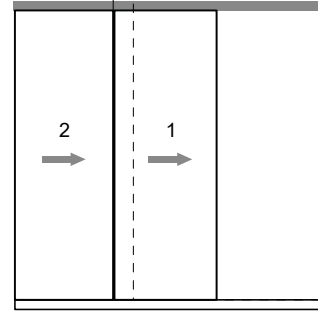

DIV-7700
TRASCINAMENTO MECCANICO
MECHANICAL DRAGGING SYSTEM
MIT MECHANISCHEM MITNEHMER



DIV-7800
TRASCINAMENTO SINCRONICO CON CINGHIA
SINCRO DRAGGING SYSTEM WITH TOOTHED BELT
SINCRO MITNEHMER KIT MIT ZAHNRIEMEN

BINARIO 2 VIE TELESCOPICO CON FISSO
TELESCOPIC 2- AYS TRACK PROFILE WITH FIXED PANEL
TELESKOP 2- EGE-LAUFSCHIENE MIT SEITENTEIL

A SOFFITTO
CEILING INSTALLATION
DECKENMONTAGE

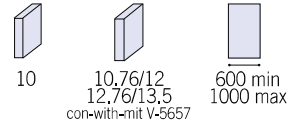

V-7703 / V-7803

Pagine tecniche - Technical pages - Technische Seiten ► 139

a soffitto
ceiling / Decke

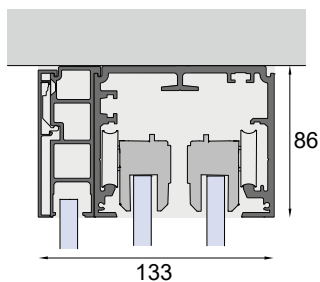
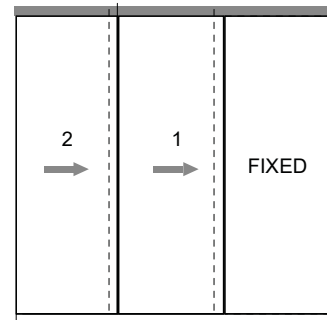

DIV-7703
TRASCINAMENTO MECCANICO
MECHANICAL DRAGGING SYSTEM
MIT MECHANISCHEM MITNEHMER



DIV-7803
TRASCINAMENTO SINCRONICO CON CINGHIA
SINCRO DRAGGING SYSTEM WITH TOOTHED BELT
SINCRO MITNEHMER KIT MIT ZAHNRIEMEN

BINARIO 2 VIE TELESCOPICO INVISIBILE
 TELESCOPIC 2- AYS INVISIBLE TRACK PROFILE
 TELESKOP 2- EGE-UNSICHTBARE LAUFSCHIENE

A SOFFITTO
 CEILING INSTALLATION
 DECKENMONTAGE

A PARETE
 ALL INSTALLATION
 ANDMONTAGE



V-7700 / V-7800 + V-7006-CF2

Pagine tecniche - Technical pages - Technische Seiten ► 140

a soffitto
 ceiling / Decke



a parete
 wall / and

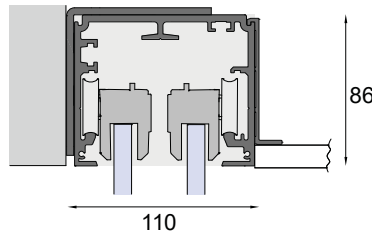
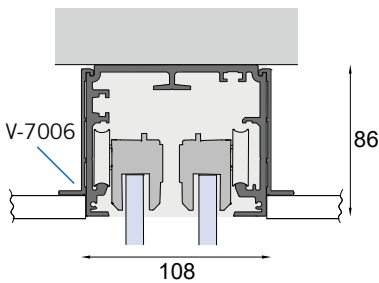
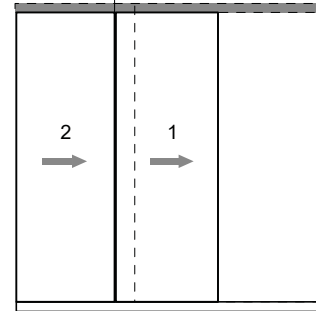

DIV-7700
 TRASCINAMENTO MECCANICO
 MECHANICAL DRAGGING SYSTEM
 MIT MECHANISCHEM MITNEHMER



DIV-7800
 TRASCINAMENTO SINCRONICO CON CINGHIA
 SINCRONICO DRAGGING SYSTEM WITH TOOTHED BELT
 SINCRONICO MITNEHMER KIT MIT ZAHNRIEMEN

BINARIO 2 VIE TELESCOPICO INVISIBILE CON FISSO
 TELESCOPIC 2- AYS INVISIBLE TRACK PROFILE WITH FIXED PANEL
 TELESKOP 2- EGE-UNSICHTBARE LAUFSCHIENE MIT SEITENTEIL

A SOFFITTO
 CEILING INSTALLATION
 DECKENMONTAGE



V-7713 / V-7813 + V-7006-CF2

Pagine tecniche - Technical pages - Technische Seiten ► 141

a soffitto
 ceiling / Decke

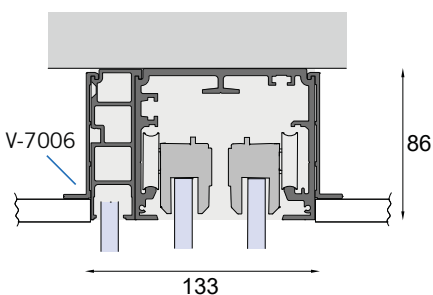
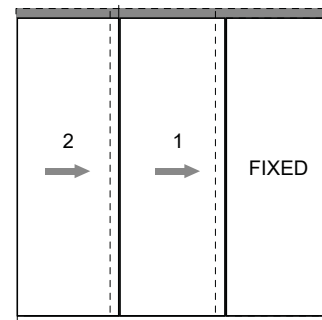

DIV-7713
 TRASCINAMENTO MECCANICO
 MECHANICAL DRAGGING SYSTEM
 MIT MECHANISCHEM MITNEHMER



DIV-7813
 TRASCINAMENTO SINCRONICO CON CINGHIA
 SINCRONICO DRAGGING SYSTEM WITH TOOTHED BELT
 SINCRONICO MITNEHMER KIT MIT ZAHNRIEMEN