

**LUCE TELESCOPICO (OPTIONAL SOFT-CLOSE)**  
BINARI A VISTA / VISIBLE TRACK PROFILES / SICHTBARE LAUFSCHIENEN



**V-7700**  
TRASCINAMENTO MECCANICO  
MECHANICAL DRAGGING SYSTEM  
MIT MECHANISCHEM MITNEHMER



**V-7800**  
TRASCINAMENTO SINCRO CON CINGHIA  
SINCRO DRAGGING SYSTEM WITH TOOTHED BELT  
SINCRO MITNEHMER KIT MIT ZAHNRIEMEN



10	10,76/12 12,76/13,5 con/with/mit V-5607	600 min 1000 max



COMPONENTI / COMPONENTS / EINZELTEILE ▶ 170



V-7700



V-7702

- Anta tutto vetro
- Frameless glass door
- Ganzglastür

V-7700 SET 1 / SET 5  
V-7800 SET 1 / SET 5

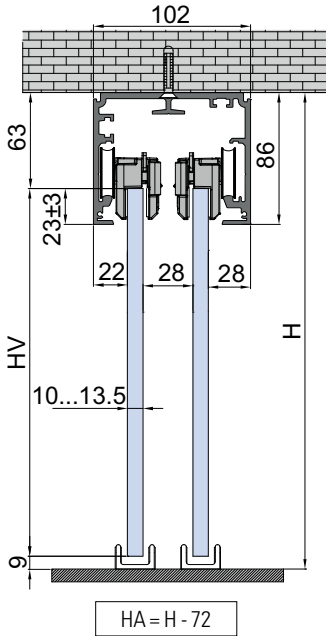

V-7700 SET 2  
V-7800 SET 2

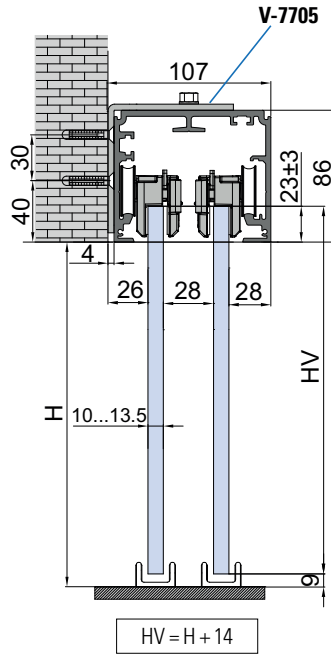

V-7706

**V-7700**  
TRASCINAMENTO MECCANICO  
MECHANICAL DRAGGING SYSTEM  
MIT MECHANISCHEM MITNEHMER



V-7806

**V-7800**  
TRASCINAMENTO SINCRONICO CON CINGHIA  
SINCRONIC DRAGGING SYSTEM WITH TOOTHED BELT  
SINCRONIC MITNEHMER KIT MIT ZAHNRIEMEN



V-7708-70 / 100

POSSIBILITÀ SOFT-CLOSE SIA IN APERTURA CHE IN CHIUSURA (1 PC + 1 PC)  
SOFT-CLOSE AVAILABLE IN OPENING AND CLOSING (1 PC + 1 PC)  
SOFT-CLOSE VERFÜGBAR FÜR ÖFFNUNG UND SCHLIÜSSUNG (1 PC + 1 PC)



- Sinistra
- Left
- Links



- Destra
- Right
- Rechts

**V-7700 / V-7800 SET 1** € S.61 € S.61.1

• Soffitto • Ceiling • Decke

**V-7700 SET 5** € S.67

• Soffitto • Ceiling • Decke

**V-7700 / V-7800 SET 2** € S.62 € S.62.1

• Parete • Wall • Wand

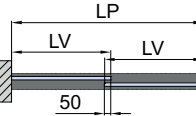
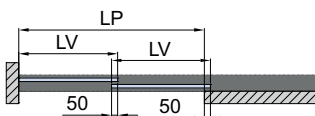
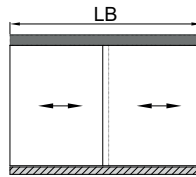
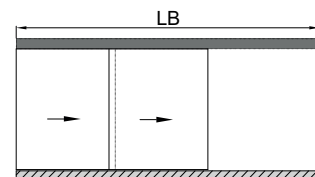

$$LB = (LP + LV) + 150$$

$$LV = (LP + 100) / 2$$

$$LB = LP$$

$$LV = (LP + 50) / 2$$

xme599e

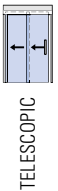

Componenti / Components / Einzelteile	Fin. / Fin. / Oberf.	V-7700 SET 1 V-7800 SET 1	V-7700 SET 2 V-7800 SET 2	V-7700 SET 5
V-7700 L=2000 L=3000 L=4000 L=6000	AN / NO / IXO / BI / BC / BS	1	1	1
V-7702	-	1	1	1
V-7706 (for V-7700) V-7806 (for V-7800)	-	1	1	-
V-7705 Staffa / Bracket / Winkelverbinder	-	-	1x400 mm	-
V-7708-70 Kg / V-7708-100 Kg (OPTIONAL)	-	(1) (2)	(1) (2)	-
V-7708-70 Kg SET 5 / V-7708-100 Kg SET 5 (OPTIONAL)	-	-	-	(1)
V-7709 tappi - endcaps - Endkappen (OPTIONAL)	AN / NO / IXO / BI / BC / BS	(1)	(1)	(1)

**LUCE TELESCOPICO (OPTIONAL SOFT-CLOSE)**  
BINARI A VISTA / VISIBLE TRACK PROFILES / SICHTBARE LAUFSCHIENEN



**V-7703**  
TRASCINAMENTO MECCANICO  
MECHANICAL DRAGGING SYSTEM  
MIT MECHANISCHEM MITNEHMER



**V-7803**  
TRASCINAMENTO SINCRO CON CINGHIA  
SINCRO DRAGGING SYSTEM WITH TOOTHED BELT  
SINCRO MITNEHMER KIT MIT ZAHNRIEMEN



10	10,76/12 12,76/13,5 con/with/mit V-5607	600 min 1000 max



TELESCOPIC



COMPONENTI / COMPONENTS / EINZELTEILE ▶ 170

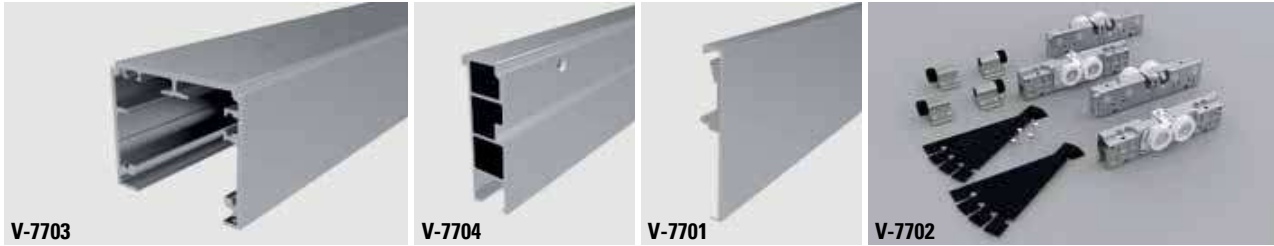

V-7703 SET 1  
V-7803 SET 1

- Anta tutto vetro
- Frameless glass door
- Ganzglastür

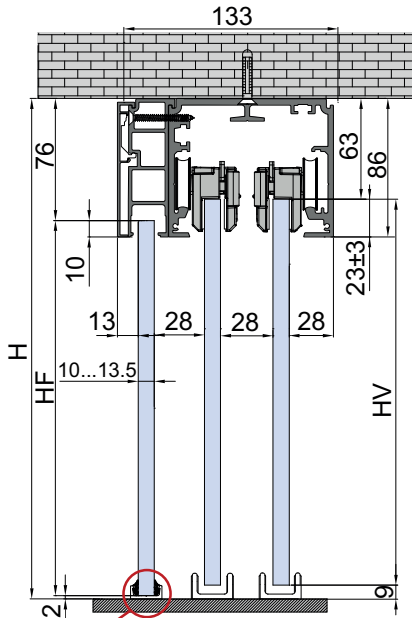

NON INCLUSO  
NOT INCLUDED  
NICHT ENTHALTEN

HV = H - 72  
HF = H - 78



V-7706  
**V-7703**  
TRASCINAMENTO MECCANICO  
MECHANICAL DRAGGING SYSTEM  
MIT MECHANISCHEM MITNEHMER



V-7806  
**V-7803**  
TRASCINAMENTO SINCRONICO CON CINGHIA  
SINCRONIC DRAGGING SYSTEM WITH TOOTHED BELT  
SINCRONIC MITNEHMER KIT MIT ZAHNRIEMEN



V-7708-70 / 100  
POSSIBILITÀ SOFT-CLOSE SIA IN APERTURA CHE IN CHIUSURA (1 PC + 1 PC)  
SOFT-CLOSE AVAILABLE IN OPENING AND CLOSING (1 PC + 1 PC)  
SOFT-CLOSE VERFÜGBAR FÜR ÖFFNUNG UND SCHLISSUNG (1 PC + 1 PC)

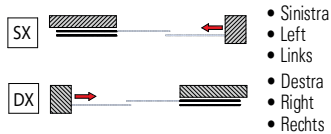

**V-7703 / V-7803 SET 1**

• Soffitto • Ceiling • Decke

€ ▶ S.64 € ▶ S.64.1

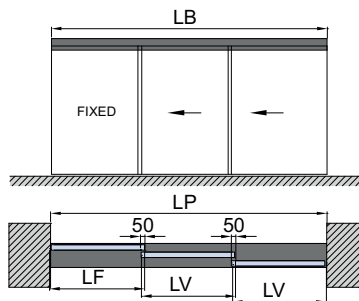

LB = LP  
LV / LF = (LP + 100) / 3

**OPTIONAL**

VP-019-MT

- Guarnizioni per sede vetro fisso
- Gaskets for fixed glass
- Dichtungen für Seitenteil

TELESCOPIC

xme599f

Componenti / Components / Einzelteile	Fin. / Fin. / Oberf.	V-7703 SET 1 V-7803 SET 1
V-7700 L=2000 L=3000 L=4000 L=6000	AN / NO / IXO / BI / BC / BS	1
V-7704 L=2000 L=3000 L=4000 L=6000	AN / NO / IXO / BI / BC / BS	1
V-7701 L=2000 L=3000 L=4000 L=6000	AN / NO / IXO / BI / BC / BS	1
V-7702	-	1
V-7706 (for V-7700) V-7806 (for V-7800)	-	1
V-7708-70 Kg / V-7708-100 Kg (OPTIONAL)	-	(1) (2)



**LUCE TELESCOPICO (OPTIONAL SOFT-CLOSE)**  
BINARI INVISIBILI / INVISIBLE TRACK PROFILES / UNSICHTBARE LAUFSCHIENEN



**V-7700**  
TRASCINAMENTO MECCANICO  
MECHANICAL DRAGGING SYSTEM  
MIT MECHANISCHEM MITNEHMER



**V-7800**  
TRASCINAMENTO SINCRO CON CINGHIA  
SINCRO DRAGGING SYSTEM WITH TOOTHED BELT  
SINCRO MITNEHMER KIT MIT ZAHNRIEMEN



10	10,76/12 12,76/13,5 con/with/mit V-5607	600 min 1000 max



TELESCOPIC

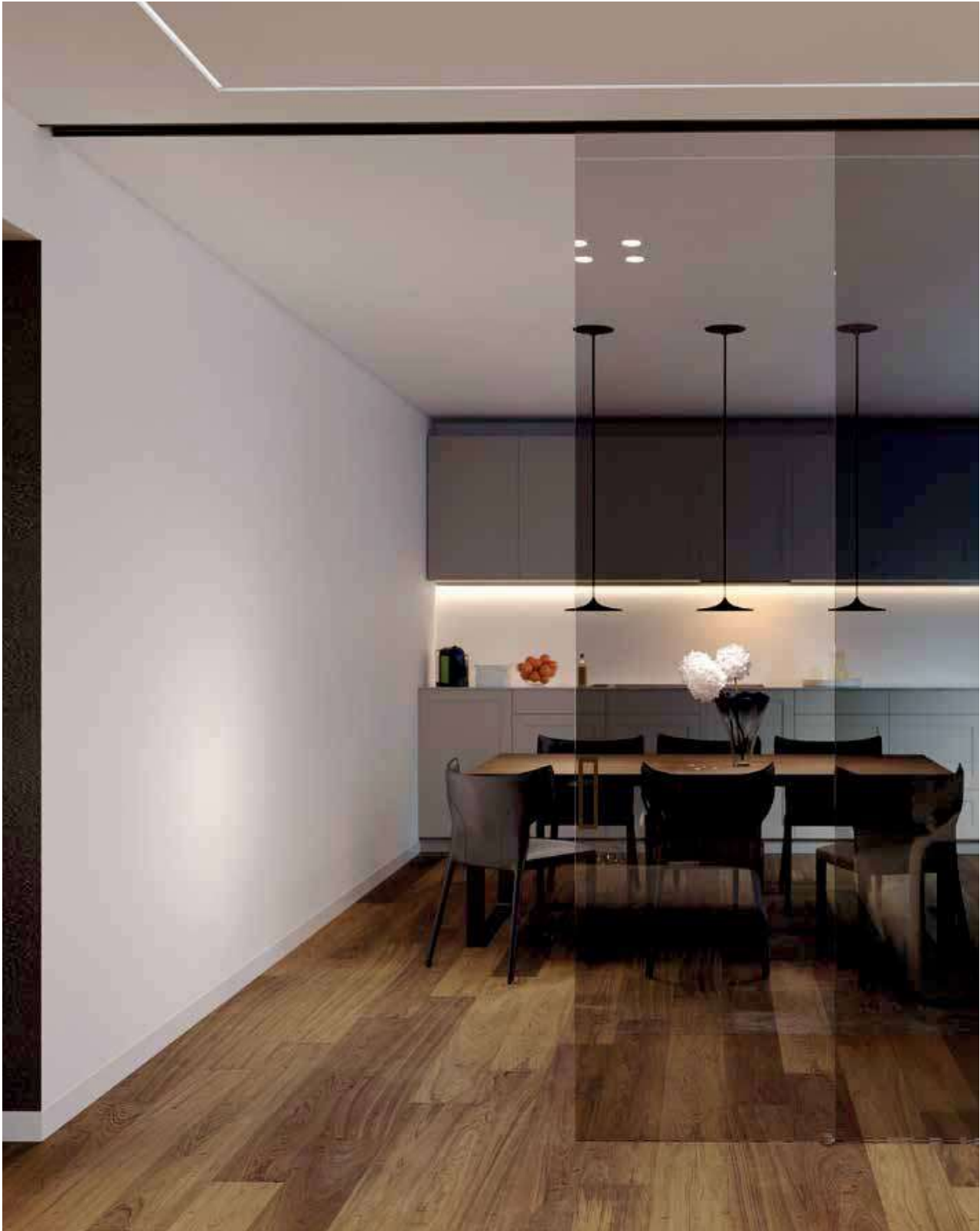

COMPONENTI / COMPONENTS / EINZELTEILE ▶ 170



V-7700

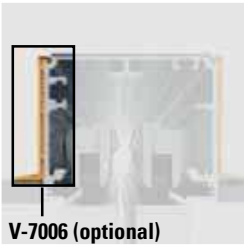

V-7006 (optional)



V-7702

- Anta tutto vetro
- Frameless glass door
- Ganzglastür

V-7700 SET 1 / SET 5  
V-7800 SET 1 / SET 5

V-7700 SET 2  
V-7800 SET 2

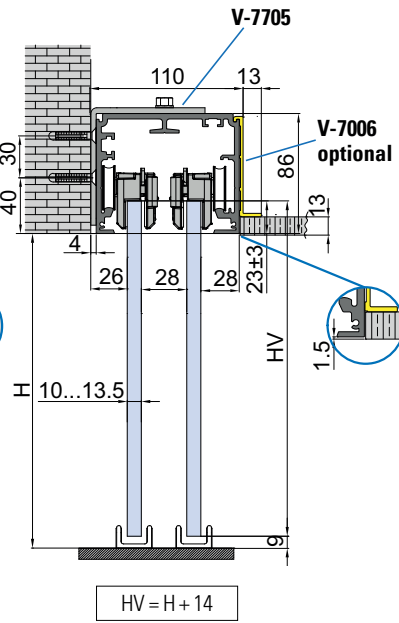
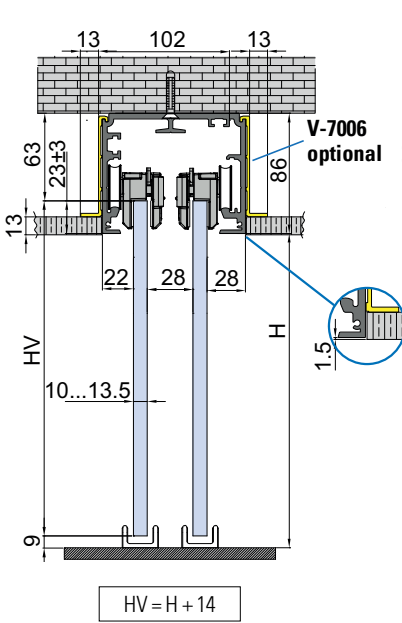

V-7706

**V-7700**  
TRASCINAMENTO MECCANICO  
MECHANICAL DRAGGING SYSTEM  
MIT MECHANISCHEM MITNEHMER



V-7806

**V-7800**  
TRASCINAMENTO SINCRONICO CON CINGHIA  
SINCRONIC DRAGGING SYSTEM WITH TOOTHED BELT  
SINCRONIC MITNEHMER KIT MIT ZAHNRIEMEN



**V-7708-70 / 100**  
POSSIBILITÀ SOFT-CLOSE SIA IN APERTURA CHE IN CHIUSURA (1 PC + 1 PC)  
SOFT-CLOSE AVAILABLE IN OPENING AND CLOSING (1 PC + 1 PC)  
SOFT-CLOSE VERFÜGBAR FÜR ÖFFNUNG UND SCHLIESSUNG (1 PC + 1 PC)

TELESCOPIC

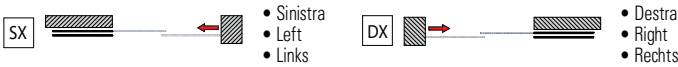

**V-7700 / V-7800 SET 1** € S.61 € S.61.1  
• Soffitto • Ceiling • Decke

**V-7700 SET 5** € S.67  
• Soffitto • Ceiling • Decke

**V-7700 / V-7800 SET 2** € S.62 € S.62.1  
• Parete • Wall • Wand

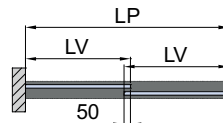
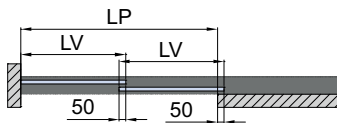
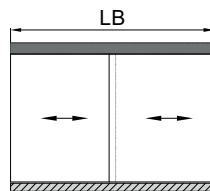
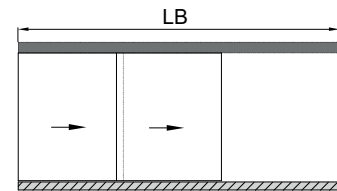

$LB = (LP + LV) + 150$   
 $LV = (LP + 100) / 2$

$LB = LP$   
 $LV = (LP + 50) / 2$

xme599g

Componenti / Components / Einzelteile	Fin. / Fin. / Oberf.	V-7700 SET 1 V-7800 SET 1	V-7700 SET 2 V-7800 SET 2	V-7700 SET 5
V-7700 L=2000 L=3000 L=4000 L=6000	AN / NO / IXO / BI / BC / BS	1	1	1
V-7006 (OPTIONAL) L=2000 L=3000 L=4000 L=6000	AN	(2)	(1)	2
V-7702	-	1	1	1
V-7706 (for V-7700) V-7806 (for V-7800)	-	1	1	-
V-7705 Staffa / Bracket / Winkelverbinder	-	-	1x400 mm	-
V-7708-70 Kg / V-7708-100 Kg (OPTIONAL)	-	(1) (2)	(1) (2)	-
V-7708-70 Kg SET 5 / V-7708-100 Kg SET 5 (OPTIONAL)	-	-	-	(1)

**LUCE TELESCOPICO (OPTIONAL SOFT-CLOSE)**  
BINARI INVISIBILI / INVISIBLE TRACK PROFILES / UNSICHTBARE LAUFSCHIENEN



**V-7713**  
TRASCINAMENTO MECCANICO  
MECHANICAL DRAGGING SYSTEM  
MIT MECHANISCHEM MITNEHMER



**V-7813**  
TRASCINAMENTO SINCRO CON CINGHIA  
SINCRO DRAGGING SYSTEM WITH TOOTHED BELT  
SINCRO MITNEHMER KIT MIT ZAHNRIEMEN



10	10,76/12 12,76/13,5 con/with/mit V-5607	600 min 1000 max



TELESCOPIC



COMPONENTI / COMPONENTS / EINZELTEILE ▶ 170

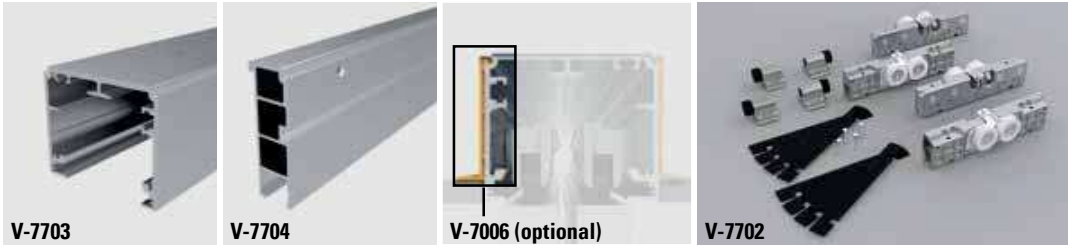

- Anta tutto vetro
- Frameless glass door
- Ganzglastür

V-7713 SET 1  
V-7813 SET 1

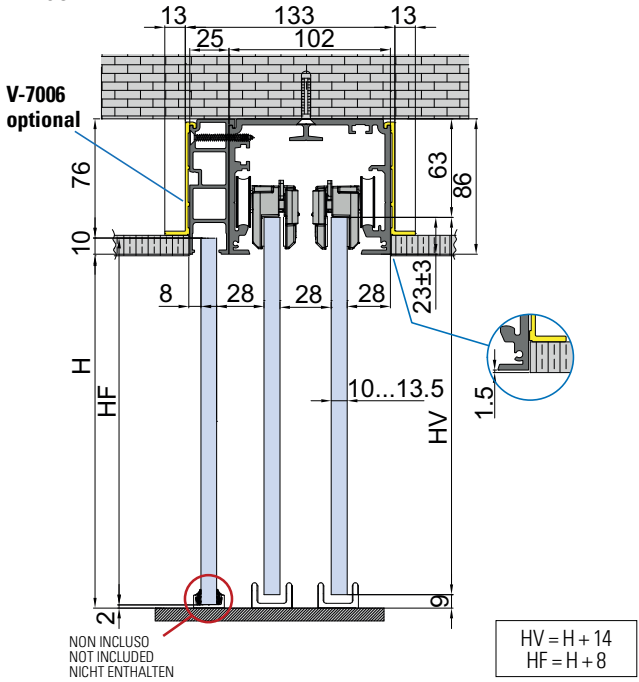

**V-7713**  
TRASCINAMENTO MECCANICO  
MECHANICAL DRAGGING SYSTEM  
MIT MECHANISCHEM MITNEHMER



**V-7813**  
TRASCINAMENTO SINCRONICO CON CINGHIA  
SINCRONIC DRAGGING SYSTEM WITH TOOTHED BELT  
SINCRONIC MITNEHMER KIT MIT ZAHNRIEMEN



POSSIBILITÀ SOFT-CLOSE SIA IN APERTURA CHE IN CHIUSURA (1 PC + 1 PC)  
SOFT-CLOSE AVAILABLE IN OPENING AND CLOSING (1 PC + 1 PC)  
SOFT-CLOSE VERFÜGBAR FÜR ÖFFNUNG UND SCHLISSUNG (1 PC + 1 PC)

TELESCOPIC

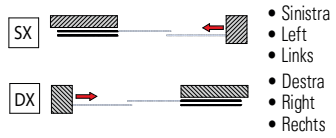

**V-7713 / V-7813 SET 1**  
• Soffitto • Ceiling • Decke

€ ▶ S.65 € ▶ S.65.1

**OPTIONAL**  
VP-019-MT

- Guarnizioni per sede vetro fisso
- Gaskets for fixed glass
- Dichtungen für Seitenteil

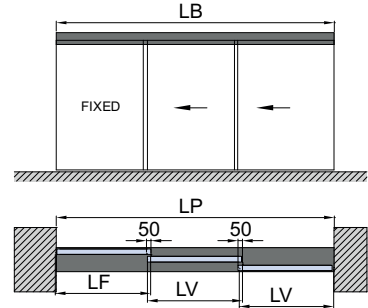

xme599h

Componenti / Components / Einzelteile	Fin. / Fin. / Oberf.	V-7713 SET 1 V-7813 SET 1
V-7700 L=2000 L=3000 L=4000 L=6000	AN / NO / IXO / BI / BC / BS	1
V-7704 L=2000 L=3000 L=4000 L=6000	AN / NO / IXO / BI / BC / BS	1
V-7702	-	1
V-7706 (for V-7700) V-7806 (for V-7800)	-	1
V-7706 (OPTIONAL) L=2000 L=3000 L=6000	AN	(2)
V-7708-70 Kg / V-7708-100 Kg (OPTIONAL)	-	(1) (2)



# LUCE TELESCOPICO

## COMPONENTI / COMPONENTS / EINZELTEILE



### V-7700

€ S.69

- Binario Telescopico a 2 vie
  - Track profile Telescopic 2 ways
  - Laufschienenprofil Telescopisch 2-bahnig
- AN-IXO-NO-BI-BC-BS

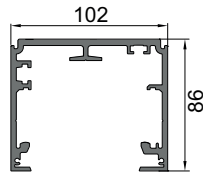

### V-7006

€ S.79

- Profilo per V-7700 con appoggio per controsoffitto.
  - Profile for V-7700 with support for suspended ceiling.
  - Profil für V-7700 mit Auflage für Abgehängter Decke
- AN-IXO-NO-BI-BC-BS

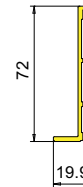

### V-7701

€ S.76

- Velella per binario telescopico V-7700 con profilo per fisso V-7704.
  - Cover profile for telescopic track V-7700 with side panel profile V-7704
  - Profiladdeckung für Laufschienenprofil mit Seitenteilprofil V-7704
- AN-IXO-NO-BI-BC-BS

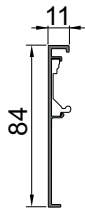

### V-7704

€ S.72

- Profilo per vetro fisso per binario V-7700
  - Side panel profile for track profile V-7700
  - Seitenteilprofil für Laufschiene V-7700
- AN-NO-IXO-BI-BC-BS

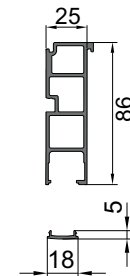

TELESCOPIC



### V-7708-70 70 KG

€ S.66

### V-7708-100 100 KG

€ S.87

- Possibilità Soft-close sia in apertura che in chiusura (1pc + 1pc)
- Soft-close available in opening and closing (1pc + 1pc)
- Soft-close verfügbar für Öffnung und Schließung (1pc + 1pc)

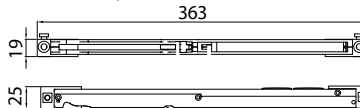
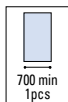
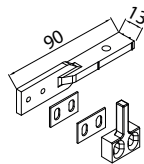

xme599m

OPTIONAL	
VP-019-MT	VP-018-MT
2	3
1000 mm - 2000 mm - 3000 mm	
<ul style="list-style-type: none"> <li>• Guarnizioni per sede vetro fisso</li> <li>• Gaskets for fixed glass</li> <li>• Dichtungen für Seitenteil</li> </ul>	
8	10
12	



### V-7708-70-SET 5 70 KG

€ S.68

### V-7708-100-SET 5 100 KG

€ S.68.1

- Kit Soft-close in apertura e chiusura per 2 ante libere (SET 5)
- Kit Soft-close opening and closing for 2 free movable panels (SET 5)
- Kit Soft-close Öffnung und Schließung für 2 frei bewegliche gegenläufige Türen (SET 5)

#### SOFT-CLOSE PANEL 1

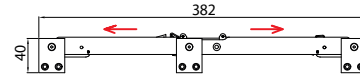

#### SOFT-CLOSE PANEL 2

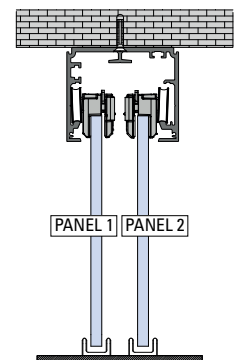
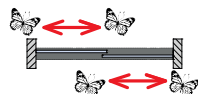
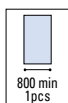
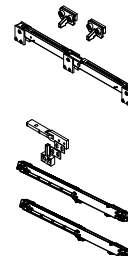
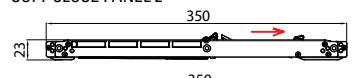

xme599m

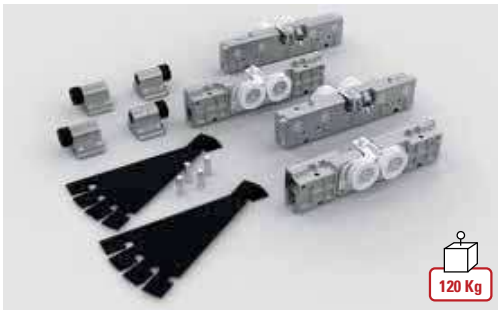

120 Kg

**V-7702**

- Set di accessori per 2 ante scorrevoli composto da: N°4 carrelli pinze, N°4 fermacarrello.
- Sliding accessory set for 2 panels complete with: N°4 roller carriers - N°4 endstops.
- Zubehör komplett mit: N°4 Klemm-Laufwagen, N°4 Endanschläge.

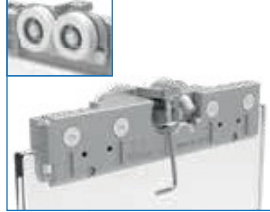

€ S.81

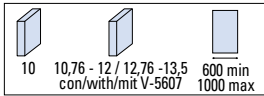

- Regolazione dal basso
- Adjustment from below
- Einstellung von unten



**V-5607**

- Set per spessori vetro 8.76 - 10.76 - 12 - 12.76 - 13.5 (per 2 pinze V-5602/V-5652/V-7602)
- Set spacers for glass thickness 8.76 - 10.76 - 12 - 12.76 - 13.5 (for 2 clamps V-5602/V-5652/V-7602)
- Set Distanzscheiben für Glasdicke 8.76 - 10.76 - 12 - 12.76 - 13.5 (für 2 Klemm-Laufwagen V-5602/V-5652/V-7602)

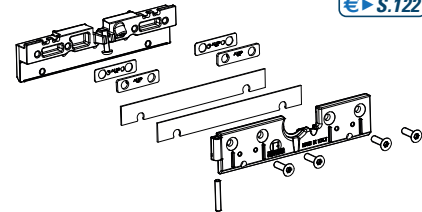

€ S.122

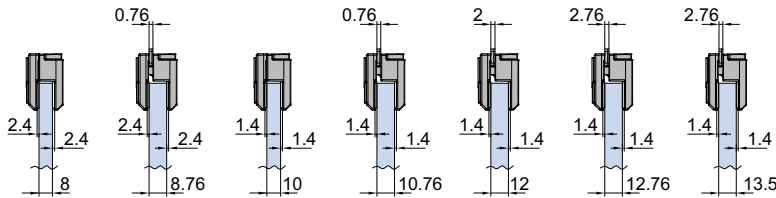
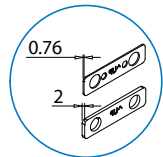

xme576i



**V-7806 DX-SX**

- Kit morsetti trascinamento Sincro con cinghia 2 ante scorrevoli a tutto vetro compreso di guide a pavimento V-012-B e V-099-C
- Dragging kit Sincro with toothed belt for 2 sliding panels, including floor guides V-012-B and V-099-C
- Mitnehmer kit Sincro mit Zahnriemen für 2 bewegliche Ganzglasschiebetüren mit Bodenführungen V-012-B und V-099-C

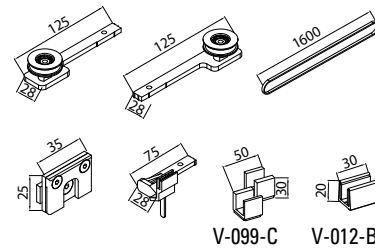
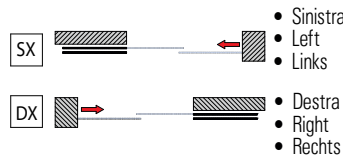

V-099-C V-012-B

xme599i



**V-7706 DX-SX**

- Kit morsetti trascinamento meccanico per 2 ante scorrevoli tutto vetro compreso di guide a pavimento V-012-B e V-099-C
- Dragging kit for 2 frameless sliding panels, including floor guides V-012-B and V-099-C
- Mitnehmer kit für 2 bewegliche Ganzglasschiebetüren mit Bodenführungen V-012-B und V-099-C

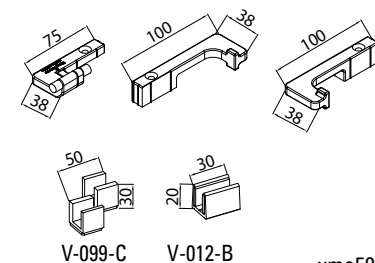
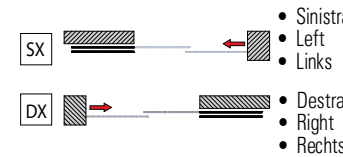

V-099-C V-012-B

xme599i

TELESCOPIC

# LUCE TELESCOPICO

## COMPONENTI / COMPONENTS / EINZELTEILE

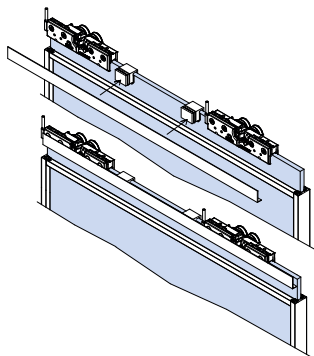

### V-7710 (OPTIONAL)

€ S.90

- Kit velette copripinze per anta A e anta B
- Kit covers for clamps for panel and panel B
- Kit Abdeckungen für Laufwagen für Schiebetür A und Schiebetür B

xme613

- 1
- Applicare biadesivo
  - Apply self-adhesive
  - Doppelseitiges Klebeband anbringen

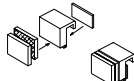

- 3
- Applicare velcro
  - Apply velcro
  - Klettverschluss anbringen

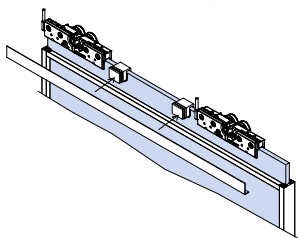

2

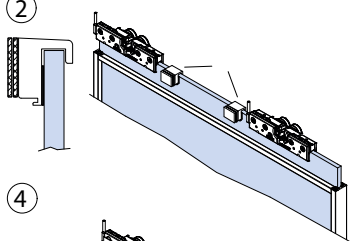

4

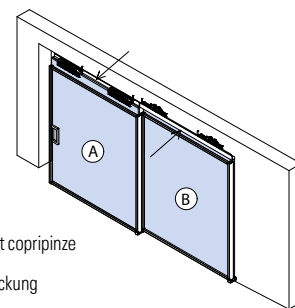
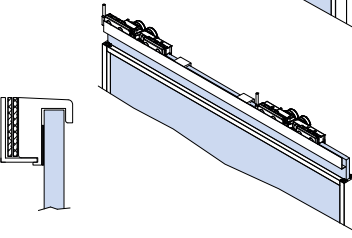

- Lato di montaggio kit copripinze
- Side for the cover
- Montageseite Abdeckung

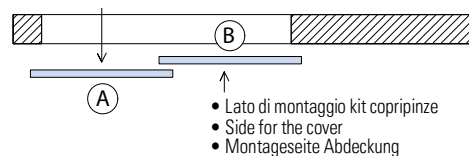

- Lato di montaggio kit copripinze
- Side for the cover
- Montageseite Abdeckung



TELESCOPIC

### V-7705

- 1 pezzo staffa per fissaggio a parete, (circa 1 pz ogni 400mm)
- 1 pc bracket for wall installation (about 1 pcs each 400 mm)
- 1 Stück Winkelverbinder für Wandmontage (1 Stück je ca. 400 mm)

€ S.88

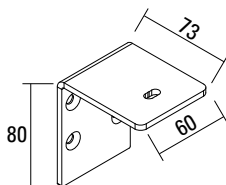

### V-7709

- Paio tappi finali per binario V-7700
- Pair endcaps for track profile V-7700
- Paar Endkappen für Laufschiene V-7700

AN-IXO-NO-BI-BC-BS



2 pcs

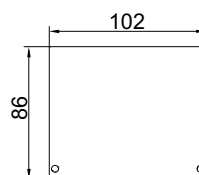

€ S.89

281p028

### V-2014-MIX

- Canalina per vetro fisso escluso guarnizioni
- U channel for fixed panel, gaskets not included
- U Profil für Seitenteil Dichtungen nicht inkl.

AN - IXE

€ S.298

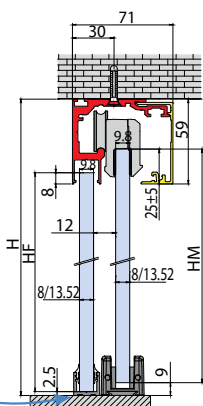
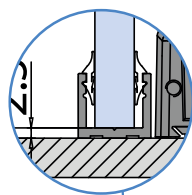

- Profilo da infilare
- Insert profile
- Profil durchziehen

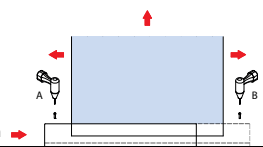

- Guarnizioni
- Gaskets
- Dichtungen

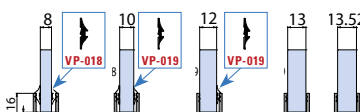

Cod.	Fin./Fin./Oberf.
V-2014-2000 mm	AN / IXE / NO
V-2014-3000 mm	AN / IXE / NO
V-2014-6000 mm	AN / IXE / NO

FB044-E