

LUCE TELESCOPICO + FRAMES (OPTIONAL SOFT-CLOSE)
VISIBLE TRACK PROFILES / SICHTBARE LAUFSCHIENEN



FRAME-FIL-O-FUSION
FRAMES / ANTE



DIV-7700
MECHANICAL DRAGGING SYSTEM
MIT MECHANISCHEM MITNEHMER



DIV-7800
SINCRO DRAGGING SYSTEM WITH TOOTHED BELT
SINCRO MITNEHMER KIT MIT ZAHNRIEMEN

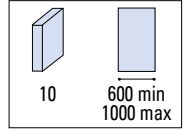

COMPONENTS / EINZELTEILE ▶ 170



- Framed panel
- Rahmentür

DIV-995 995 x 2980 mm
DIV-1495 1495 x 2980 mm
DIV-FIX-995 995 x 2980 mm
DIV-FIX-1495 1495 x 2980 mm

 FRAME-FILO-FUSION
 FRAMES / ANTE

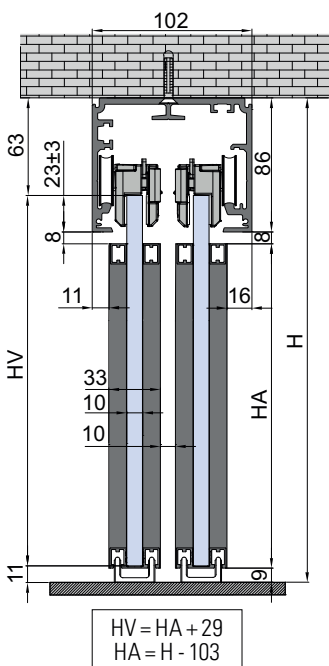
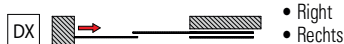
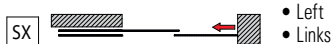
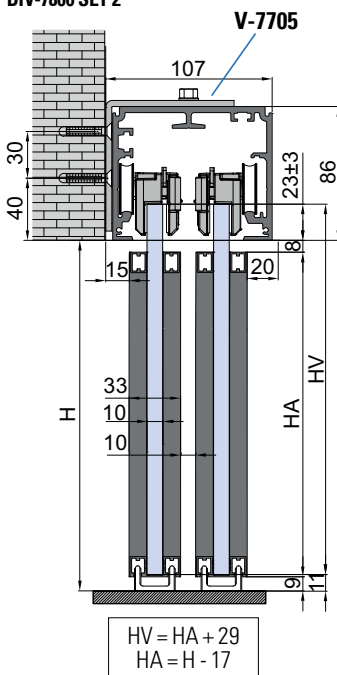
DIV-7700 SET 1 / SET 5
DIV-7800 SET 1 / SET 5

DIV-7700 SET 2
DIV-7800 SET 2

DIV-7700 / DIV-7800 SET 1

• Ceiling • Decke

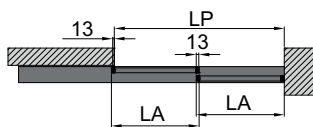
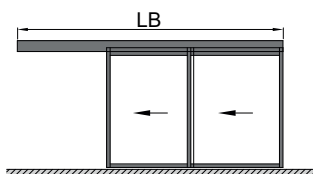
DIV-7700 / DIV-7800 SET 2

• Wall • Wand

DIV-7700 SET 5

• Ceiling • Decke

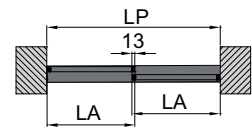
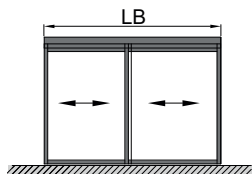
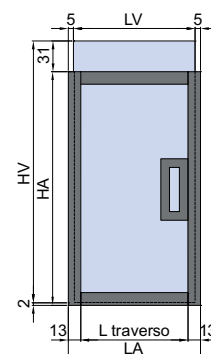
 FRAMED PANEL
 GERAHMTE TÜR

L horizontal profile = LA - 26
 L Horizontalprofil = LA - 26

xme599c

Components / Einzelteile ▶ 170	Fin. / Oberf.	DIV-7700 DIV-7800 SET 1	DIV-7700 DIV-7800 1,5 SET 1	DIV-7700 DIV-7800 SET 2	DIV-7700 DIV-7800 1,5 SET 2	DIV-7700 SET 5	DIV-7700 1,5 SET 5
V-7700 L=2000 L=3000 L=4000 L=6000	AN / NO / IXO / BI / BC / BS	1	1	1	1	1	1
V-7702	-	1	1	1	1	1	1
DIV-7706 (for DIV-7700) DIV-7806 (for DIV-7800)	-	1	1	1	1	-	-
V-7705 Bracket / Winkelverbinder	-	-	-	1x400 mm	1x400 mm	-	-
V-7708-70 Kg / V-7708-100 Kg (OPTIONAL) SOFT-CLOSE	-	(1) (2)	(1) (2)	(1) (2)	(1) (2)	-	-
V-7708-70 Kg SET 5 / V-7708-100 Kg SET 5 (OPTIONAL) SOFT-CLOSE	-	-	-	-	-	(1)	(1)
V-7709 endcaps - Endkappen (OPTIONAL)	AN / NO / IXO / BI / BC / BS	(1)	(1)	(1)	(1)	(1)	(1)
DIV-995 framed panel - gerahmte Tür 995 x 2980	AN / NO / IXO / BI / BC / BS	2	-	2	-	2	-
DIV-1495 framed panel - gerahmte Tür 1495 x 2980	AN / NO / IXO / BI / BC / BS	-	2	-	2	-	2
DIV-204 cross profile - Querprofil (OPTIONAL)	AN / NO / IXO / BI / BC / BS	(n)	(n)	(n)	(n)	(n)	(n)

FRAMES

FRAMED PANEL / GERAHMTE TÜR



FINISHING RANGE / OBERFLÄCHEN-SORTIMENT



IX0
• Inox effect
• Inox Effekt



BC
• Light bronze
• Hellbraun



BS
• Dark bronze
• Dunkelbraun



AN
• Silver anodized
• Aluminium Silberfarbig



BI
• Matt white
• Weiß matt



NO
• Matt black
• Schwarz matt

PROFILE DIMENSION / PROFILGRÖSSE

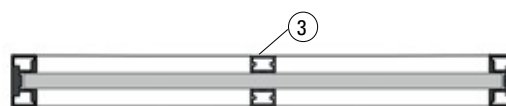

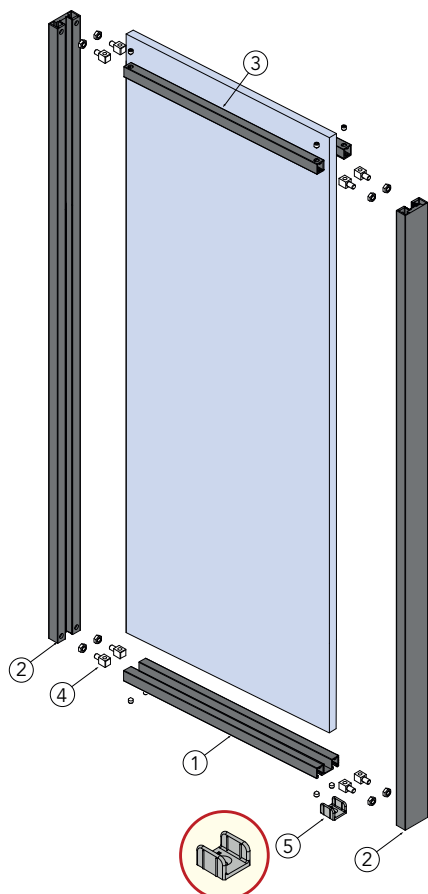
PANEL SET
DIV-995 995 x 2980 mm

DIV-1495 1495 x 2980 mm

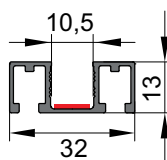
- ① **DIV-203**
- Horizontal bottom profile
 - Unterer Horizontalprofil

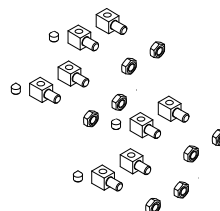

- ④ **P-F37**
- Assembly kit
 - Montage-Kit



- ② **DIV-202**
- Vertical profile
 - Vertikalprofil

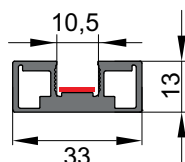

- ⑤ **DIV-012**
- Door guide
 - Bodenführung



- ③ **DIV-204**
- Cross profile
 - Querprofil

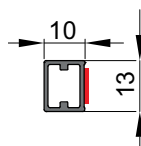

- ⑥ **DIV-01**
- Drilling template
 - Bohrschablone

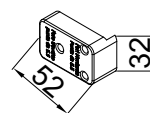

- Pre-installed double-side adhesive
 • Selbstklebend

SET FIXED PANEL
DIV-FIX-995 995 x 2980 mm

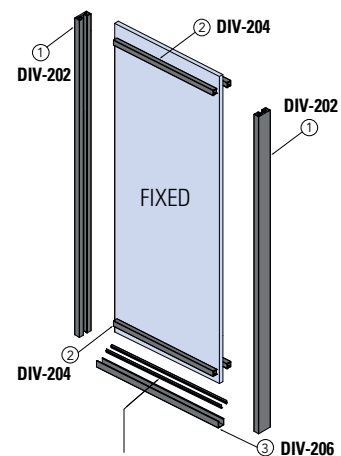
DIV-FIX-1495 1495 x 2980 mm

- Gaskets for DIV-206 included
 • Dichtungen für DIV-206 enthalten

FRAMES

FRAMED PANEL / GERAHMTE TÜR

FRAME=FILO-FUSION
FRAMES / ANTE

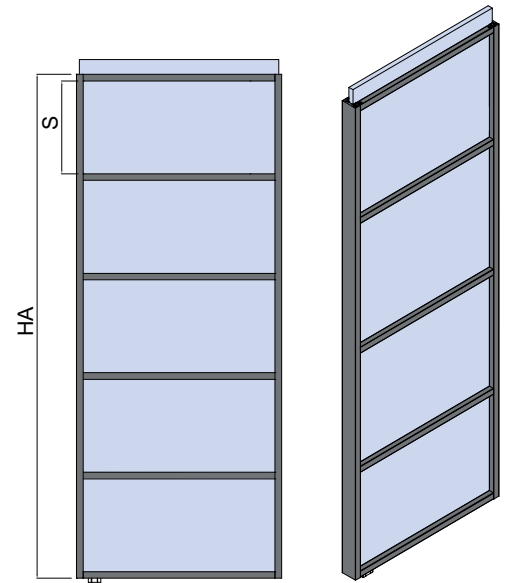

$$V = HA - (13 \times 6)$$

$$S = V / 5$$

- V and VL are values only for calculation
- V und VL sind Werte nur für die Berechnung

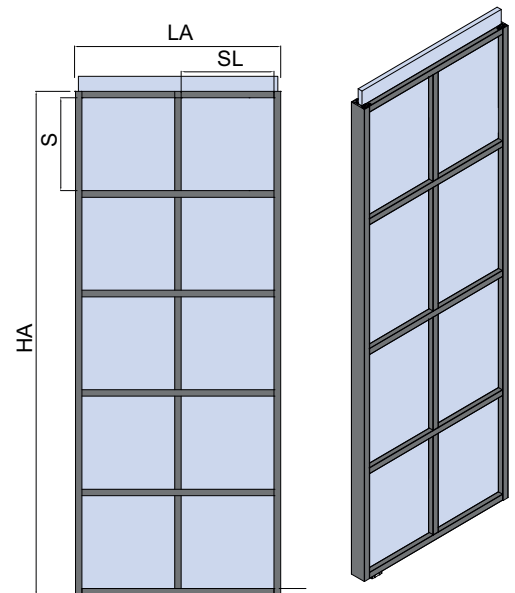

$$V = HA - (13 \times 6)$$

$$S = V / 5$$

$$VL = LA - 39$$

$$SL = VL / 2$$

MY METALGLAS

Configure your panel to calculate the cross profiles
Konfigurieren Sie Ihre Tür und berechnen Sie automatisch die Querprofile

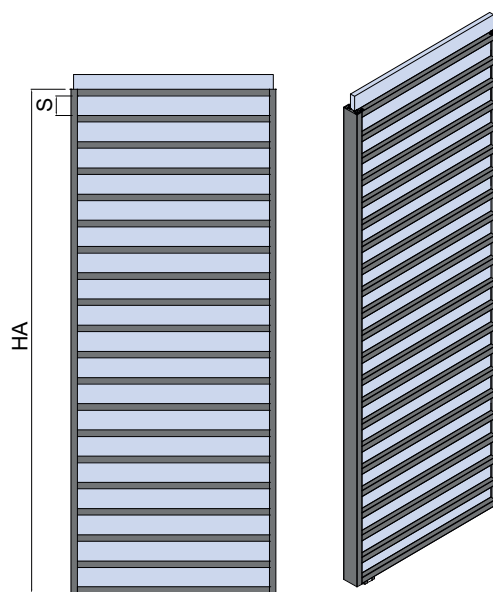

$$V = HA - (13 \times N)$$

$$S = V / (N - 1)$$

- N° cross profiles
- N° Querprofile

FRAME-FILO-FUSION
FRAMES / ANTE

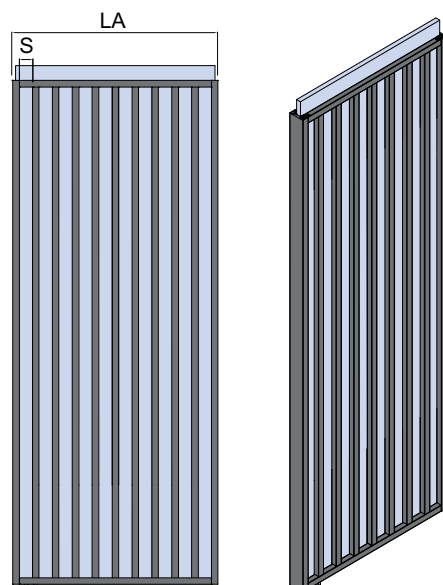

$$VL = LA - (13 \times N)$$

$$S = VL / (N - 1)$$

- N° vertical profiles
- N° Vertikalleisten

LUCE TELESCOPICO

COMPONENTS / EINZELTEILE



V-7700

- Track profile Telescopic 2 ways
- Laufschieneprofil Telescopisch 2-bahnig
- AN-IXO-NO-BI-BC-BS

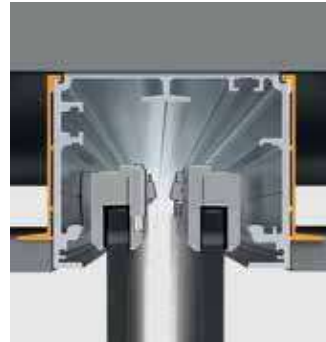
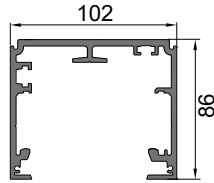

V-7706

- Profile for V-7700 with support for suspended ceiling.
- Profil für V-7700 mit Auflage für Abgehängter Decke
- AN-IXO-NO-BI-BC-BS

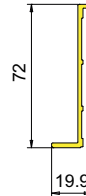

V-7701

- Cover profile for telescopic track V-7700 with side panel profile V-7704
- Profilabdeckung für Laufschieneprofil mit Seitenteilprofil V-7704
- AN-IXO-NO-BI-BC-BS

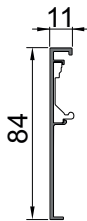

V-7704

- Side panel profile for track profile V-7700
- Seitenteilprofil für Laufschiene V-7700
- AN-NO-IXO-BI-BC-BS

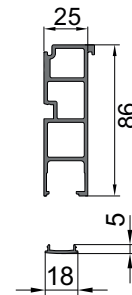

TELESCOPIC



V-7708-70 70 KG
V-7708-100 100 KG

- Soft-close available in opening and closing (1pc + 1pc)
- Soft-close verfügbar für Öffnung und Schließung (1pc + 1pc)

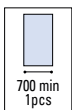
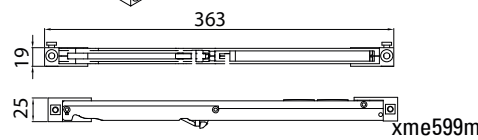
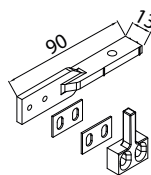

OPTIONAL	
VP-019-MT	VP-018-MT
2	3
1000 mm - 2000 mm - 3000 mm	
<ul style="list-style-type: none"> Gaskets for fixed glass Dichtungen für Seitenteil 	
8	10
12	



V-7708-70-SET 5 70 KG
V-7708-100-SET 5 100 KG

- Kit Soft-close opening and closing for 2 free movable panels (SET 5)
- Kit Soft-close Öffnung und Schließung für 2 frei bewegliche gegenläufige Türen (SET 5)

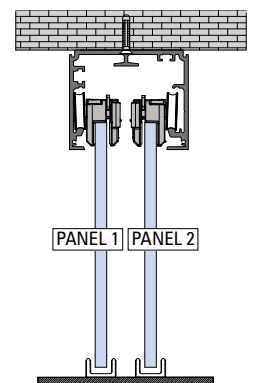
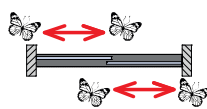
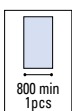
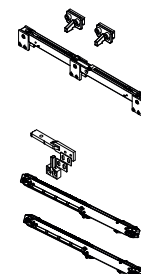
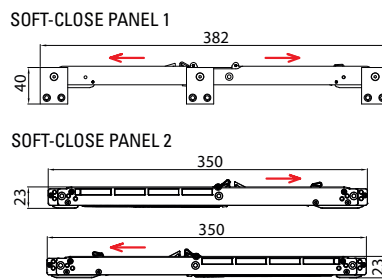

xme599m

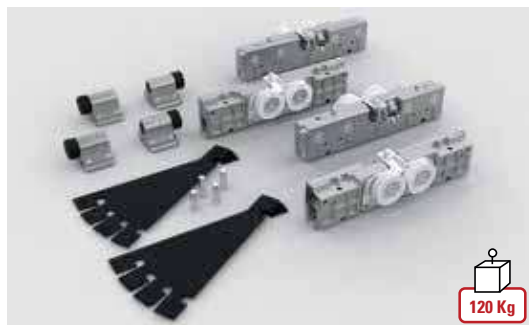
V-7702

- Sliding accessory set for 2 panels complete with: N°4 roller carriers - N°4 endstops.
- Zubehör komplett mit: N°4 Klemm-Laufwagen, N°4 Endanschläge.

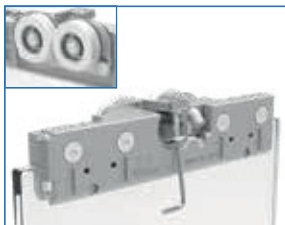

120 Kg

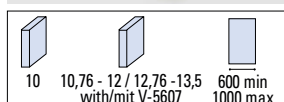

- Adjustment from below
- Einstellung von unten

V-5607

- Set spacers for glass thickness 8.76 - 10.76 - 12 - 12.76 - 13.5 (for 2 clamps V-5602/V-5652/V-7602)
- Set Distanzscheiben für Glasdicke 8.76 - 10.76 - 12 - 12.76 - 13.5 (für 2 Klemm-Laufwagen V-5602/V-5652/V-7602)

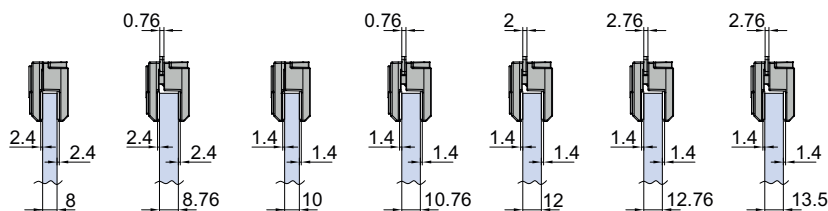
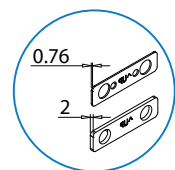
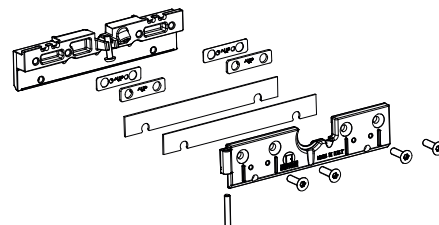

xme576i

V-7806 DX-SX

- Dragging kit Sincro with toothed belt for 2 sliding panels, including floor guides V-012-B and V-099-C
- Mitnehmer kit Sincro mit Zahnriemen für 2 bewegliche Ganzglasschiebetüren mit Bodenführungen V-012-B und V-099-C

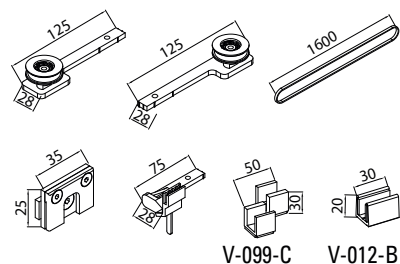
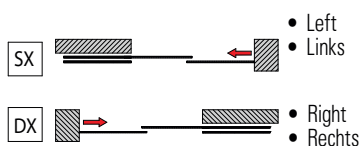

xme599i

V-7706 DX-SX

- Dragging kit for 2 frameless sliding panels, including floor guides V-012-B and V-099-C
- Mitnehmer kit für 2 bewegliche Ganzglasschiebetüren mit Bodenführungen V-012-B und V-099-C

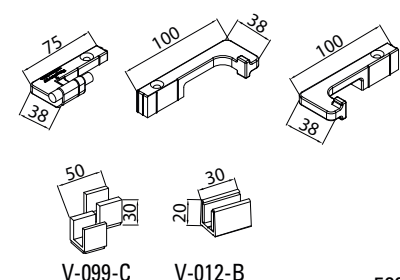
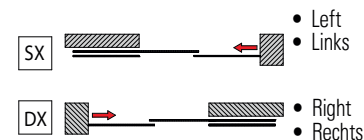

xme599i

TELESCOPIC

LUCE TELESCOPICO

COMPONENTS / EINZELTEILE

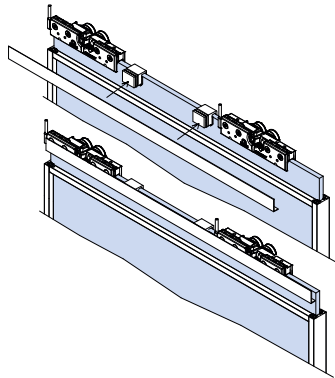

V-7710 (OPTIONAL)

- Kit covers for clamps for panel and panel B
- Kit Abdeckungen für Laufwagen für Schiebetür A und Schiebetür B

xme613

- ① • Apply self-adhesive
• Doppelseitiges Klebeband anbringen

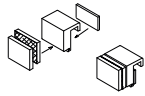

- ③ • Apply velcro
• Klettverschluss anbringen

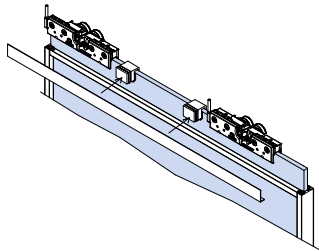

②

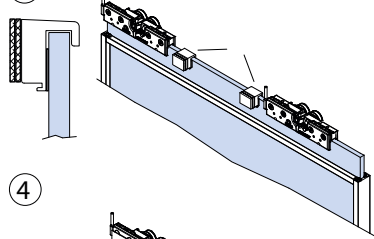

④

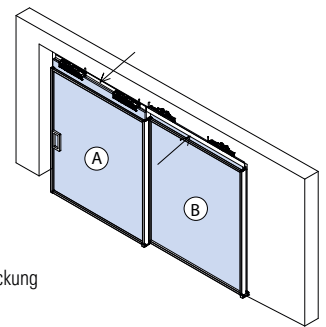
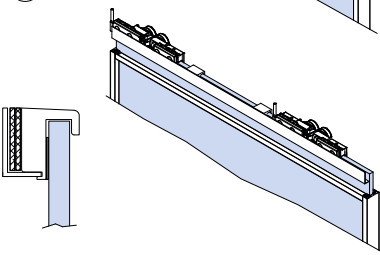

- Side for the cover
- Montageseite Abdeckung

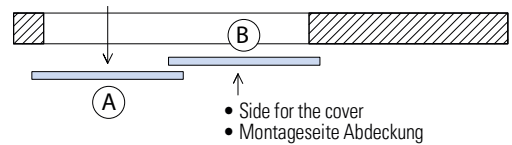

- Side for the cover
- Montageseite Abdeckung



TELESCOPIC

V-7705

- 1 pc bracket for wall installation (about 1 pcs each 400 mm)
- 1 Stück Winkelverbinder für Wandmontage (1 Stück je ca. 400 mm)

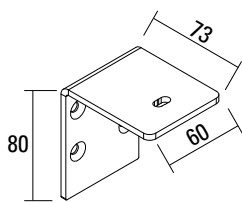

V-7709

- Pair endcaps for track profile V-7700
- Paar Endkappen für Laufschiene V-7700

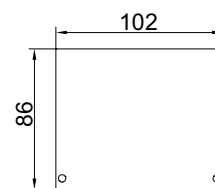

281p028

V-2014-MIX

- U channel for fixed panel, gaskets not included
 - U Profil für Seitenteil Dichtungen nicht inkl.
- AN - IXE

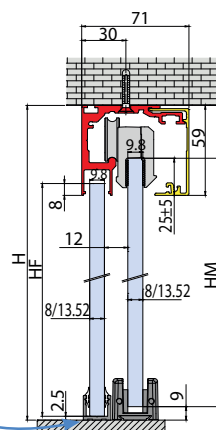
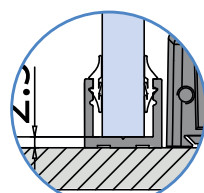

- Insert profile
- Profil durchziehen
- Gaskets
- Dichtungen

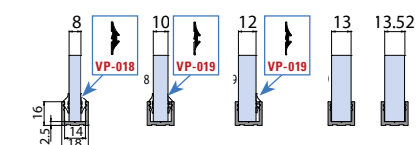
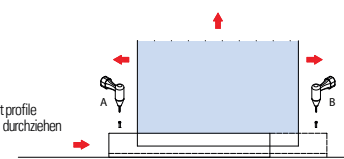

FB044-E

LUCE TELESCOPICO + FRAMES

COMPONENTS / EINZELTEILE

PANEL SET
DIV-995 995 x 2980 mm
DIV-1495 1495 x 2980 mm

① **DIV-203**
 • Horizontal bottom profile
 • Unterer Horizontalprofil

② **DIV-202**
 • Vertical profile
 • Vertikalprofil

③ **DIV-204**
 • Cross profile
 • Querprofil

④ **P-F37**
 • Assembly kit
 • Montage-Kit

⑤ **DIV-012**
 • Door guide
 • Bodenführung

⑥ **DIV-01**
 • Drilling template
 • Bohrschablone

• Pre-installed double-side adhesive
 • Selbstklebend

SET FIXED PANEL
DIV-FIX-995 995 x 2980 mm
DIV-FIX-1495 1495 x 2980 mm

① **DIV-202** ② **DIV-204** ③ **DIV-206**

• Gaskets for DIV-206 included
 • Dichtungen für DIV-206 enthalten

DIV-KIT

- Fixing materials and floor guide to assembly 1 framed panel FRAME
- Befestigungsmaterial und Bodenführung für 1 set Flügelrahmen FRAME

OPTIONAL

VP-019-MT	VP-018-MT
2	3
1000 mm	
2000 mm	
3000 mm	

• Gaskets for fixed glass
 • Dichtungen für Seitenteil

SINCRO

DIV-7806 DX-SX

- Dragging kit Sincro with framed for 2 sliding panels, including floor guides FUS-TS12 and DIV-099
- Mitnehmer kit Sincro mit Zahnriemen für 2 bewegliche Rahmentüren mit Bodenführungen FUS-TS12 und DIV-099

• Left Links
 • Right Rechts

DIV-099 **FUS-TS12**
xme599i

DIV-7706 DX-SX

- Dragging kit for 2 framed sliding panels, including floor guides FUS-TS12 and DIV-099
- Mitnehmer kit für 2 bewegliche Rahmentüren mit Bodenführungen FUS-TS12 und DIV-099

• Left Links
 • Right Rechts

DIV-099 **FUS-TS12**
xme599i

ACCESSORIES FRAMED DOORS

ZUBEHÖREN GERAHMTE TÜREN

FRAME=FILC-FUSION
FRAMES / ANTE

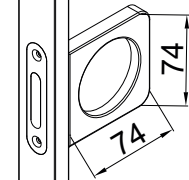
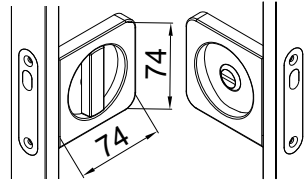

DIV-009

- Lock with hook for framed sliding door
- Schloss mit Hakenriegel für gerahmte Schiebetür
- AN-IXO-NO-BI-BC-BS

DIV-009 2FLG

- Strike box for framed sliding door
- Gegenkasten für gerahmte Schiebetür
- AN-IXO-NO-BI-BC-BS

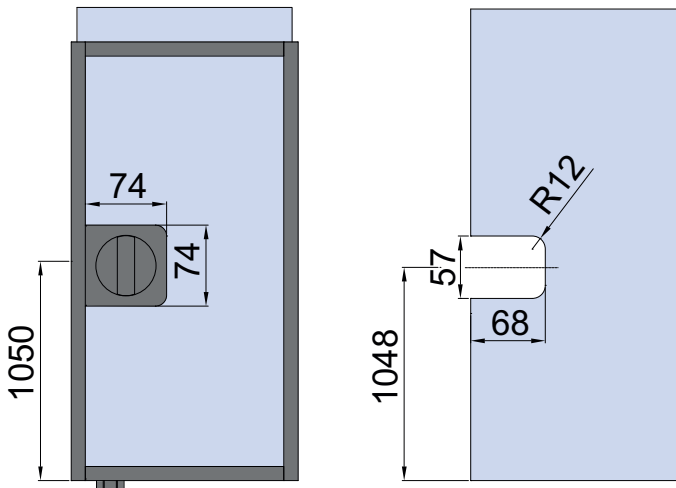

- Glass preparation for lock DIV-009 and strike box DIV-009 2FLG
- Glasbearbeitung für Schloss DIV-009 und Gegenkasten DIV-009 2FLG

xme595m/xme595r

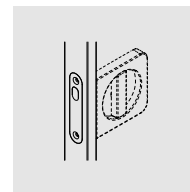
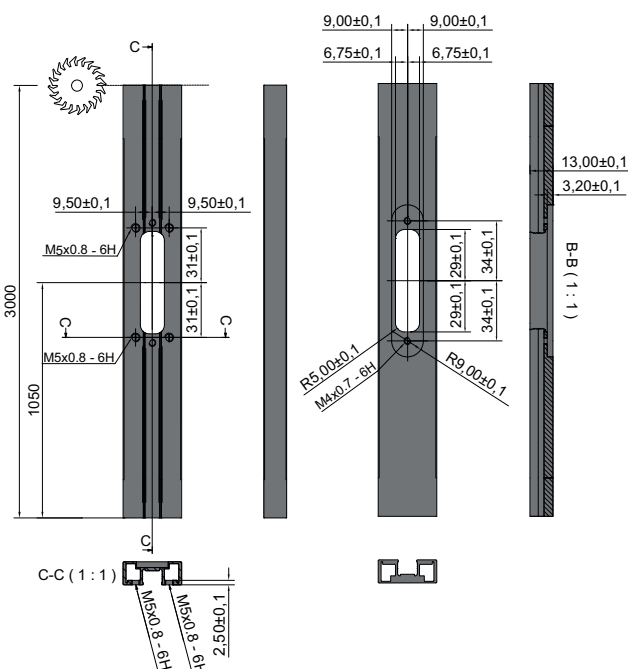

SET:

- Profiles for aluminium panel with machining for lock DIV-009 or strike box DIV-009 2FLG (not included)
- Flügelrahmen mit Bearbeitung für Schloss DIV-009 oder Gegenkasten DIV-009 2FLG (nicht enthalten)

FRAME:

DIV-SER-995 995 x 2980 mm

DIV-SER-1495 1495 x 2980 mm

FUSION:

FUS-SER-995 995 x 2980 mm

FUS-SER-1495 1495 x 2980 mm

xme595n

DIV-010

- Pull-lever for framed panel
- Stiringriff für gerahmte Tür CP-CR-IXO



1pc

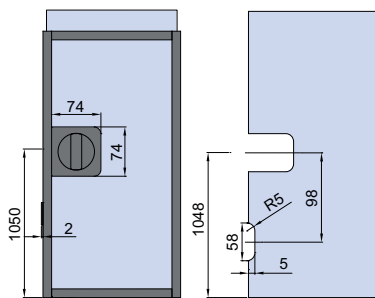
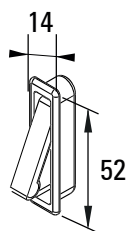

- Glass preparation for lock DIV-009 and pull-lever DIV-010
- Glasbearbeitung für Schloss DIV-009 und Stiringriff DIV-010

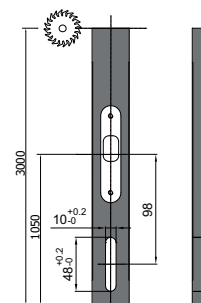

LAV-DIV-010

- Profile preparation for pull-lever DIV-010
- Profilbearbeitung für Stiringriff DIV-010

FUS-TS12

- Floor guide for FUSION panel with pocket system
- Bodenführung für FUSION Tür mit kastensystem

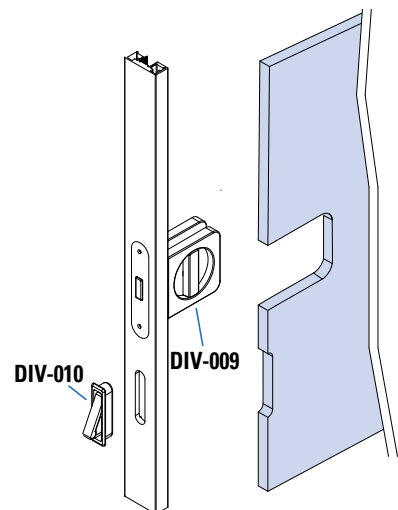
xme595r



- PLEASE NOTE: double pocket sliding doors
- ACHTUNG: 2-flügelige Schiebetüren in der Wand laufend

- Strike box front-plate not recessed
- Gegenkasten Stulp nicht versenkt

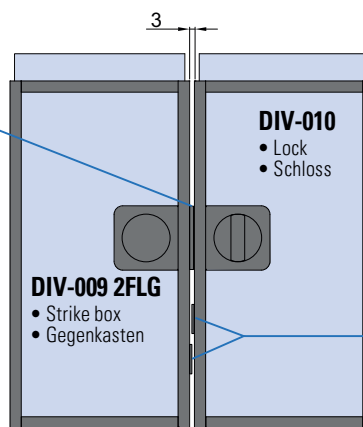

- Pull-levers not on same level for correct locking
- Stiringriffe nicht auf gleicher Ebene um Schloss zu Schliessen

xme595r

DIV-008

- Pair sliding door-handles with self-adhesive fixing
- Paar Griffmuscheln selbstklebend

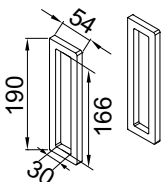
DIV-007

- Pair sliding door-handles with self-adhesive fixing
- Paar Griffmuscheln selbstklebend

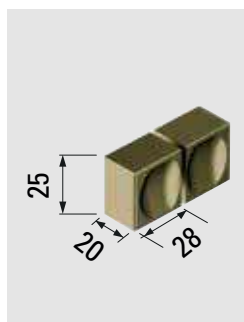
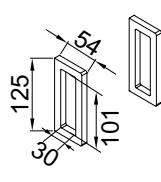
B-196

- Pair of doorknobs
- Paar Türkнопfe

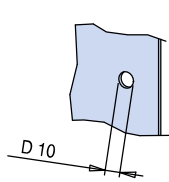
V-532-INC

- Pc sliding door-handle with self-adhesive fixing
- Stück Griffmuschel selbstklebend

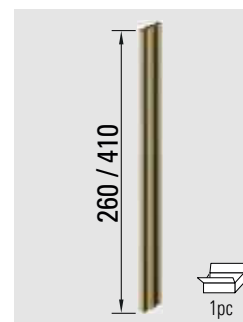
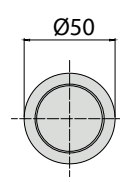
POR-0408V

- Pc pullhandle with self-adhesive fixing
- Stück Stossgriff selbstklebend



xme595m/xfb-139