

INVISIBLE + FRAMES (OPTIONAL SOFT-CLOSE)
INVISIBLE TRACK PROFILES / UNSICHTBARE LAUFSCHIENEN



DIV-7603



120 Kg

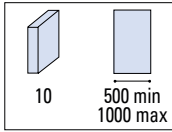

FRAME-FIL-O-FUSION
FRAMES / ANTE

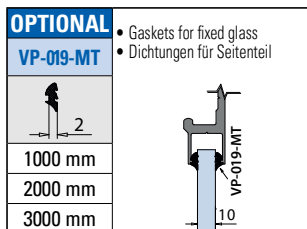
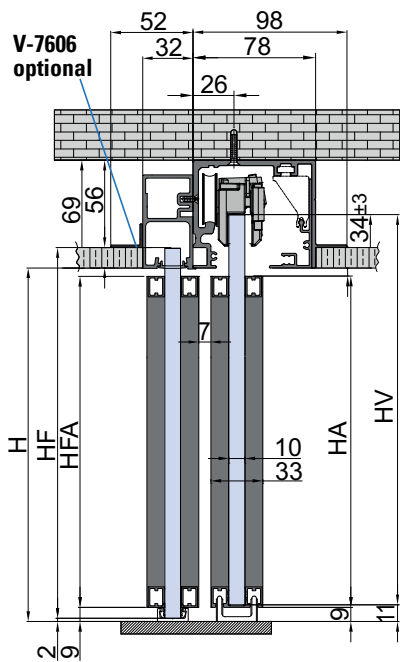

COMPONENTS / EINZELTEILE ▶ 130

 FRAME-FILO-FUSION
 FRAMES / ANTE

$$\begin{aligned}
 HV &= H + 23 \\
 HF &= HV - 11 \\
 HA &= HV - 37 \\
 HFA &= HF - 25
 \end{aligned}$$

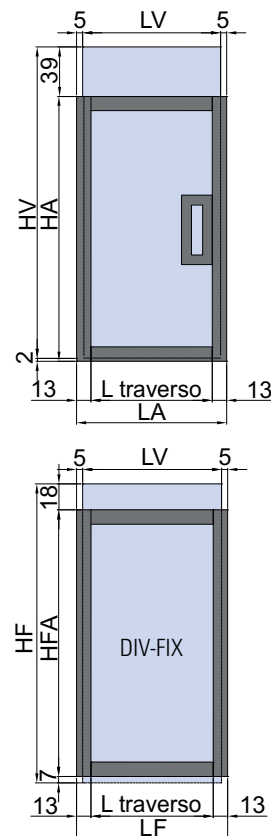
 FRAMED PANEL
 GERÄHMTE TÜR

DIV-7603 SET 1

- Sliding framed door set with fixed panel, wall/ceiling installation
- Schiebetürset für 1 fig mit Seitenteil, Wand-Deckenmontage mit Flügelrahmen

DIV-7603 SET 2

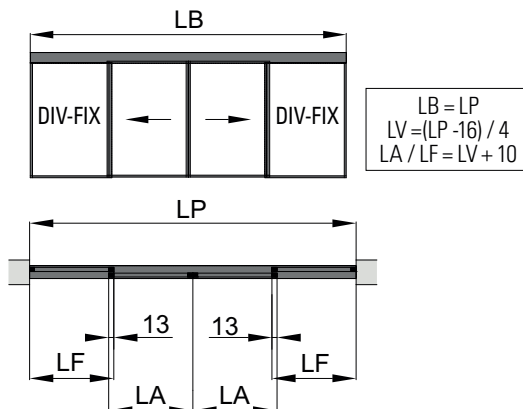
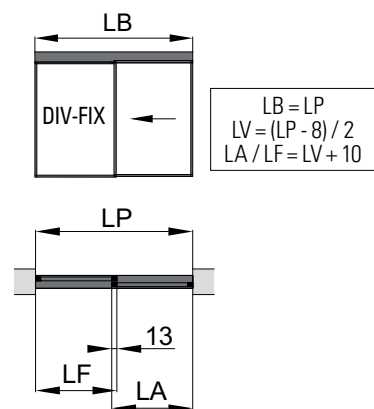
- Sliding framed doors set with fixed panels, wall/ceiling installation
- Schiebetürset für 2 fig mit Seitenteile, Wand-Deckenmontage mit Flügelrahmen



L horizontal profile = LA - 26
 L Horizontalprofil = LA - 26

- Security glass holes **optional**
- Sicherheitsbohrungen **optional**

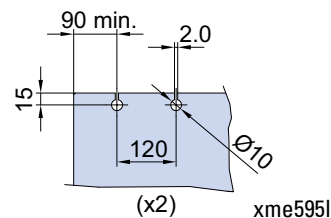

Components / Einzelteile ▶ 130	Fin. / Oberf.	DIV-7603 SET 1	DIV-7603-1,5 SET 1	DIV-7603 SET 2	DIV-7603-1,5 SET 2
V-7600 L=2000 L=3000 L=4000 L=6000	AN	1	1	1	1
V-7606 L=2000 L=3000 L=4000 L=6000 (OPTIONAL)	GR	(1)	(1)	(1)	(1)
DIV-205 L=2000 L=3000 L=4000 L=6000	AN / NO / IXO / BI / BC / BS	1	1	1	1
V-7602	-	1	1	2	2
V-5606-70 Kg / V-5606-80 Kg / V-5606-100 Kg / V-5606-120 Kg (OPTIONAL)	-	(1)	(1)	(2)	(2)
DIV-995 framed panel - gerahmte Tür 995 x 2980	AN / NO / IXO / BI / BC / BS	1	-	2	-
DIV-1495 framed panel - gerahmte Tür 1495 x 2980	AN / NO / IXO / BI / BC / BS	-	1	-	2
DIV-FIX-995 framed panel - gerahmte Tür 995 x 2980	AN / NO / IXO / BI / BC / BS	1	-	2	-
DIV-FIX-1495 framed panel - gerahmte Tür 1495 x 2980	AN / NO / IXO / BI / BC / BS	-	1	-	2
DIV-204 cross profile - Querprofil (OPTIONAL)	AN / NO / IXO / BI / BC / BS	(n)	(n)	(n)	(n)

FRAMES

FRAMED PANEL / GERAHMTE TÜR



FINISHING RANGE / OBERFLÄCHEN-SORTIMENT



IX0
• Inox effect
• Inox Effekt



BC
• Light bronze
• Hellbraun



BS
• Dark bronze
• Dunkelbraun



AN
• Silver anodized
• Aluminium Silberfarbig



BI
• Matt white
• Weiß matt



NO
• Matt black
• Schwarz matt

PROFILE DIMENSION / PROFILGRÖSSE

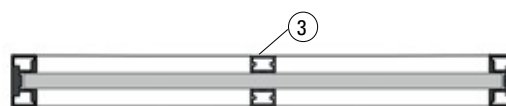

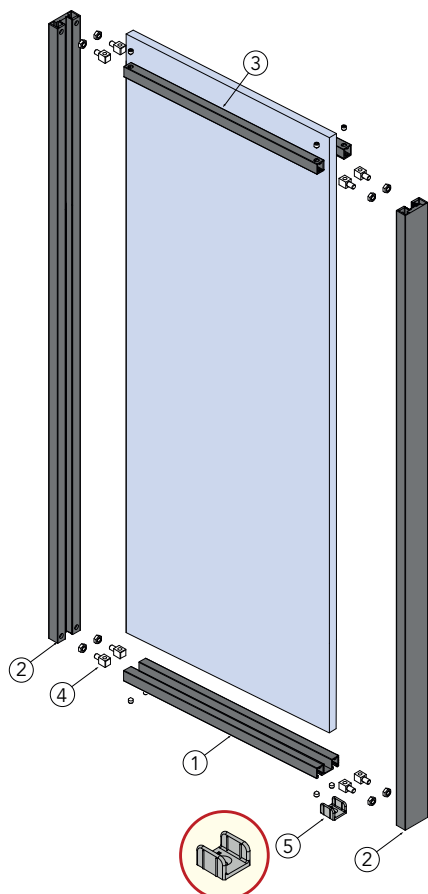
PANEL SET
DIV-995 995 x 2980 mm

DIV-1495 1495 x 2980 mm

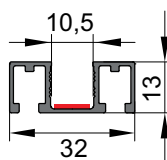
- ① **DIV-203**
- Horizontal bottom profile
 - Unterer Horizontalprofil

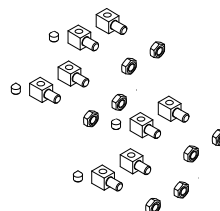

- ④ **P-F37**
- Assembly kit
 - Montage-Kit



- ② **DIV-202**
- Vertical profile
 - Vertikalprofil

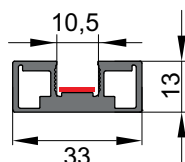

- ⑤ **DIV-012**
- Door guide
 - Bodenführung



- ③ **DIV-204**
- Cross profile
 - Querprofil

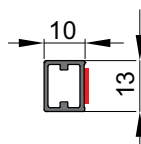

- ⑥ **DIV-01**
- Drilling template
 - Bohrschablone

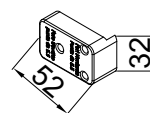

- Pre-installed double-side adhesive
- Selbstklebend

SET FIXED PANEL
DIV-FIX-995 995 x 2980 mm

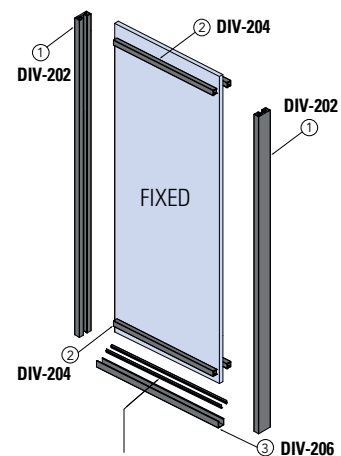
DIV-FIX-1495 1495 x 2980 mm

- Gaskets for DIV-206 included
- Dichtungen für DIV-206 enthalten

FRAMES

FRAMED PANEL / GERAHMTE TÜR

FRAME=FILO-FUSION
FRAMES / ANTE

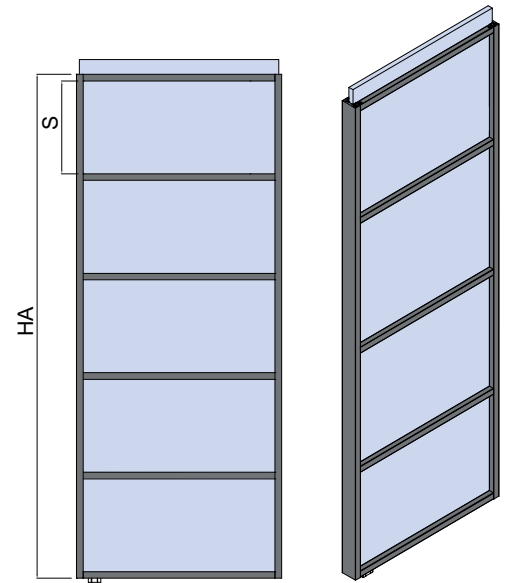

$$V = HA - (13 \times 6)$$

$$S = V / 5$$

- V and VL are values only for calculation
- V und VL sind Werte nur für die Berechnung

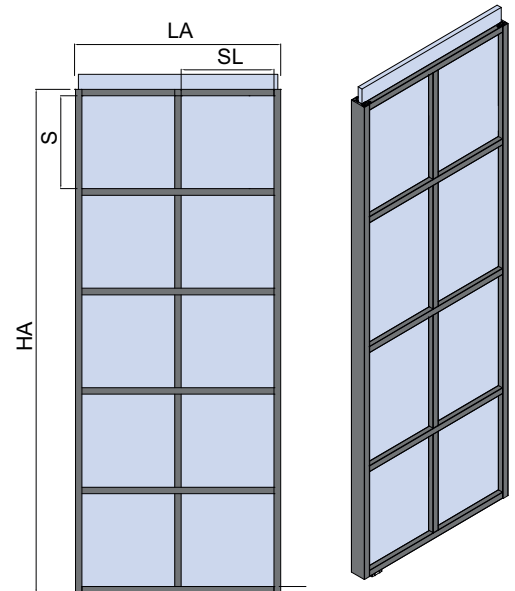

$$V = HA - (13 \times 6)$$

$$S = V / 5$$

$$VL = LA - 39$$

$$SL = VL / 2$$

MY METALGLAS

Configure your panel to calculate the cross profiles
Konfigurieren Sie Ihre Tür und berechnen Sie automatisch die Querprofile



FRAME-FILO-FUSION
FRAMES / ANTE

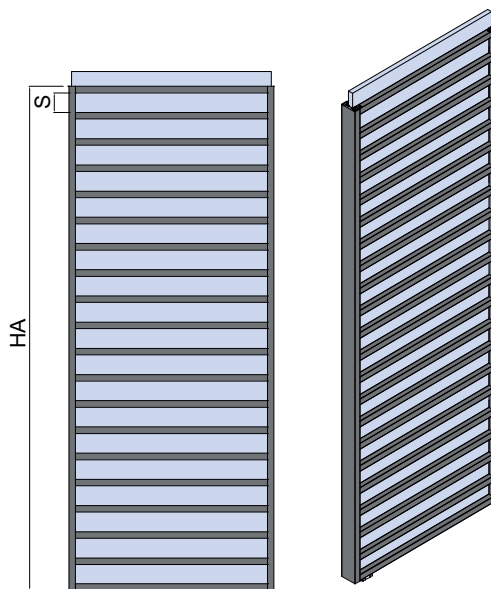

$$V = HA - (13 \times N)$$

$$S = V / (N - 1)$$

- N° cross profiles
- N° Querprofile

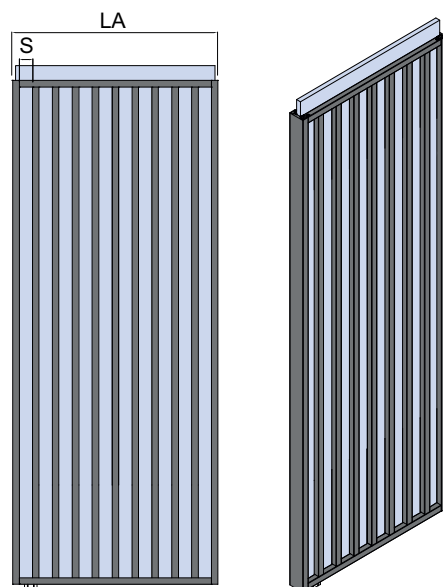

$$VL = LA - (13 \times N)$$

$$S = VL / (N - 1)$$

- N° vertical profiles
- N° Vertikalleisten

INVISIBLE (OPTIONAL SOFT-CLOSE)

INVISIBLE TRACK PROFILES / UNSICHTBARE LAUFSCHIENEN

COMPONENTS / EINZELTEILE



V-7600

- Track profile with profile cover
 - Führungsschiene mit Profilabdeckung
- AN

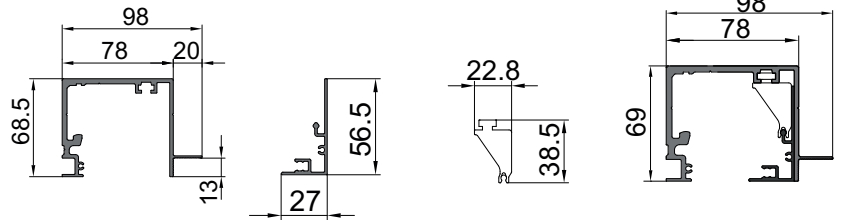

xme576f

INVISIBLE



V-7603

- Track profile for sliding panel and fixed side panel
 - Laufschiene für Schiebetür und Seitenteil
- AN

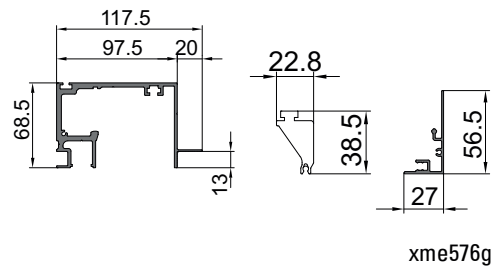

OPTIONAL	
VP-019-MT	VP-018-MT
2	3
1000 mm - 2000 mm - 3000 mm	
<ul style="list-style-type: none"> • Gaskets for fixed glass • Dichtungen für Seitenteil 	
8	10
12	



V-7605

- Profile for V-7600/V-7603 with support for suspended ceiling
 - Profil für V-7600/V-7603 mit Auflage für Abgehängter Decke
- GR

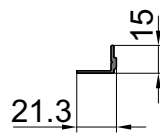

xme576g



V-7650

- Track profile with profile cover
 - Führungsschiene mit Profilabdeckung
- AN

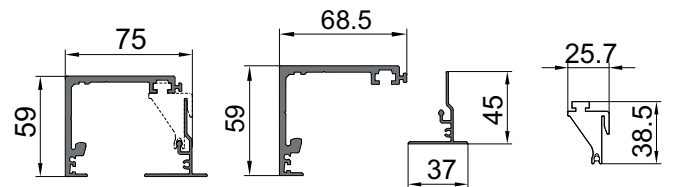

xme576e



V-7602

- Accessories set for 1 sliding panel consisting of:
n° 2 roller carriers for 8/10 mm glass,
n° 2 stoppers
- Zubehör für 1 Schiebetür bestehend aus:
n° 2 Klemm - Laufwagen für 8/10 mm Glas,
n° 2 Stopper

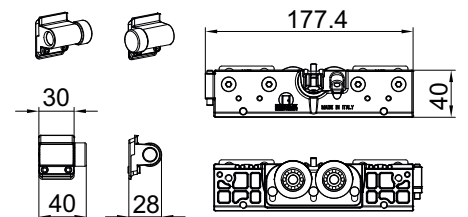

- Adjustment from below
- Einstellung von unten

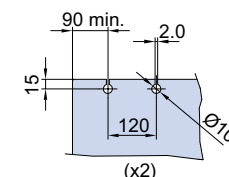
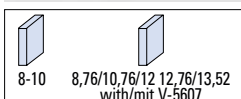

- Security glass holes **optional**
- Sicherheitsbohrungen **optional**

xme576e



soft-close
70 Kg

V-5606-70

- Set 2 stoppers Soft-close (for 1 sliding panel)
- Set 2 Stoppers Soft-close mit Selbststeinzug (für 1 Schiebetür)

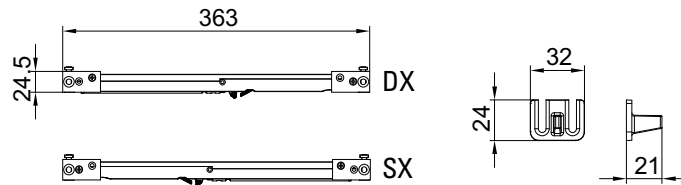

xme576d



soft-close
80 Kg

V-5606-80

- Set 2 stoppers Soft-close (for 1 sliding panel)
- Set 2 Stoppers Soft-close mit Selbststeinzug (für 1 Schiebetür)

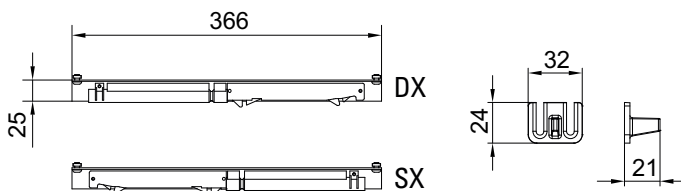

xme576d



100 Kg 120 Kg

V-5606-100 100 KG

V-5606-120 120 KG

- Set 2 stoppers Soft-close (for 1 sliding panel)
- Set 2 Stoppers Soft-close mit Selbststeinzug (für 1 Schiebetür)

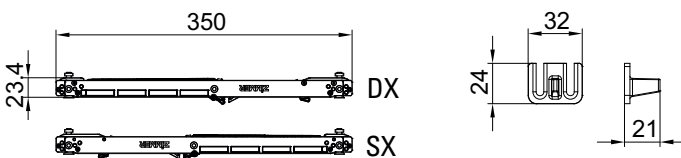

xme576d



V-5607

- Set spacers for glass thickness 8.76 - 10.76 - 12 - 12.76 - 13.5 (for 2 clamps V-5602/V-5652/V-7602)
- Set Distanzscheiben für Glasdicke 8.76 - 10.76 - 12 - 12.76 - 13.5 (für 2 Klemm-Lauwagen V-5602/V-5652/V-7602)

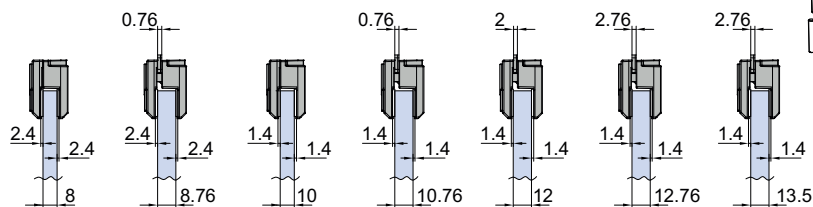
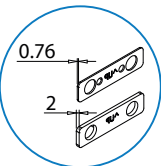
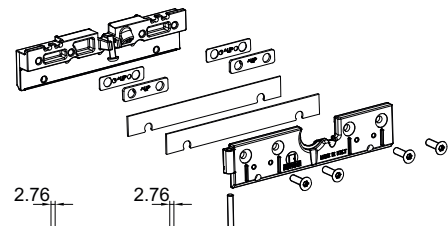

xme576i



V-012-INS

- Floor guide adjustable for glass from 8 to 13,5 mm. Perfect for invisible and Telescopic
- Bodenführung verstellbar für Glas von 8 bis 13,5mm perfekt für invisibile und Teleskop Schiebe-Systeme, dank der Befestigungsplatte einsetzbar

AN - NS - CR

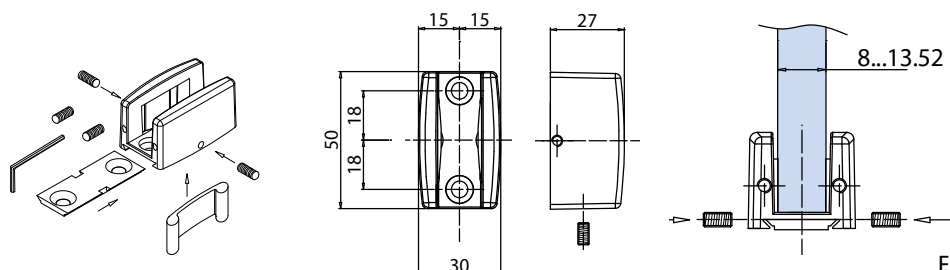

FB059-A

8-10-12
12.5-13-13.5

INVISIBLE

INVISIBLE + FRAMES (OPTIONAL SOFT-CLOSE)

COMPONENTS / EINZELTEILE

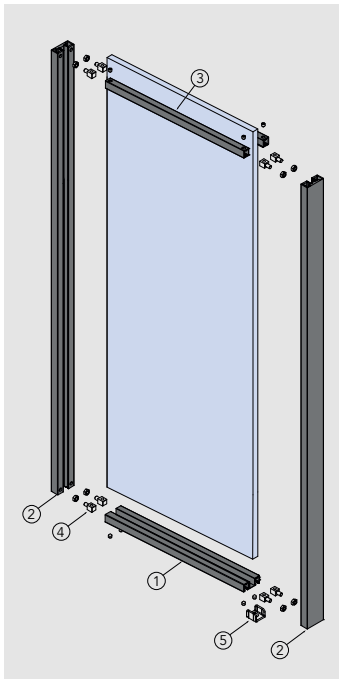

PANEL SET
DIV-995 995 x 2980 mm
DIV-1495 1495 x 2980 mm

① **DIV-203**
 • Horizontal bottom profile
 • Unterer Horizontalprofil

② **DIV-202**
 • Vertical profile
 • Vertikalprofil

③ **DIV-204**
 • Cross profile
 • Querprofil

④ **P-F37**
 • Assembly kit
 • Montage-Kit

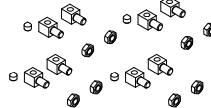
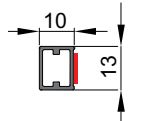
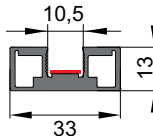
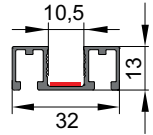

⑤ **DIV-012**
 • Door guide
 • Bodenführung



⑥ **DIV-01**
 • Drilling template
 • Bohrschablone

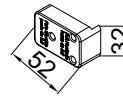

• Pre-installed double-side adhesive
 • Selbstklebend

SET FIXED PANEL
DIV-FIX-995 995 x 2980 mm
DIV-FIX-1495 1495 x 2980 mm

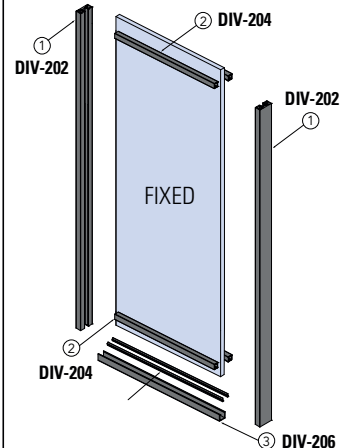

• Gaskets for DIV-206 included
 • Dichtungen für DIV-206 enthalten

INVISIBLE

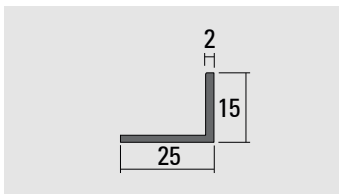

V-7606
 • Support profile for suspended ceiling with profile DIV-205
 • Profil mit Auflage für Abgehängter Decke mit Profil DIV-205
 GR

V-7606



DIV-205
 • Side profile for fixed framed panel FRAME with V-5600/V-7600 track profiles
 • Seitenteilprofil für FRAME Flügelrahmen mit Laufschiene V-5600/V-7600

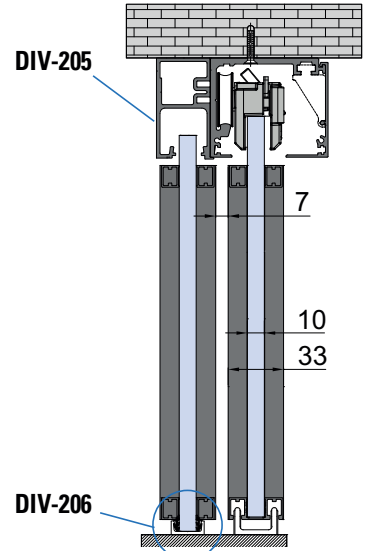
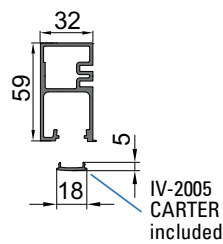

xme595m

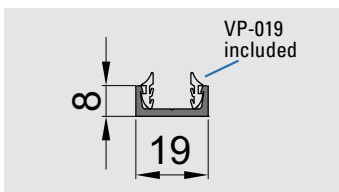

DIV-206
 • Bottom "U" channel for fixed panel FRAME gaskets included
 • Unteres "U" Profil für Seitenteil FRAME, Dichtungen enthalten
 NO

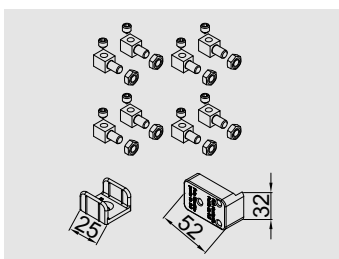

DIV-KIT
 • Fixing materials and floor guide to assembly 1 framed panel FRAME
 • Befestigungsmaterial und Bodenführung für 1 set Flügelrahmen FRAME

OPTIONAL		• Gaskets for fixed glass • Dichtungen für Seitenteil
VP-019-MT	VP-018-MT	
2	3	
1000 mm		
2000 mm		
3000 mm		
8	10	
12		

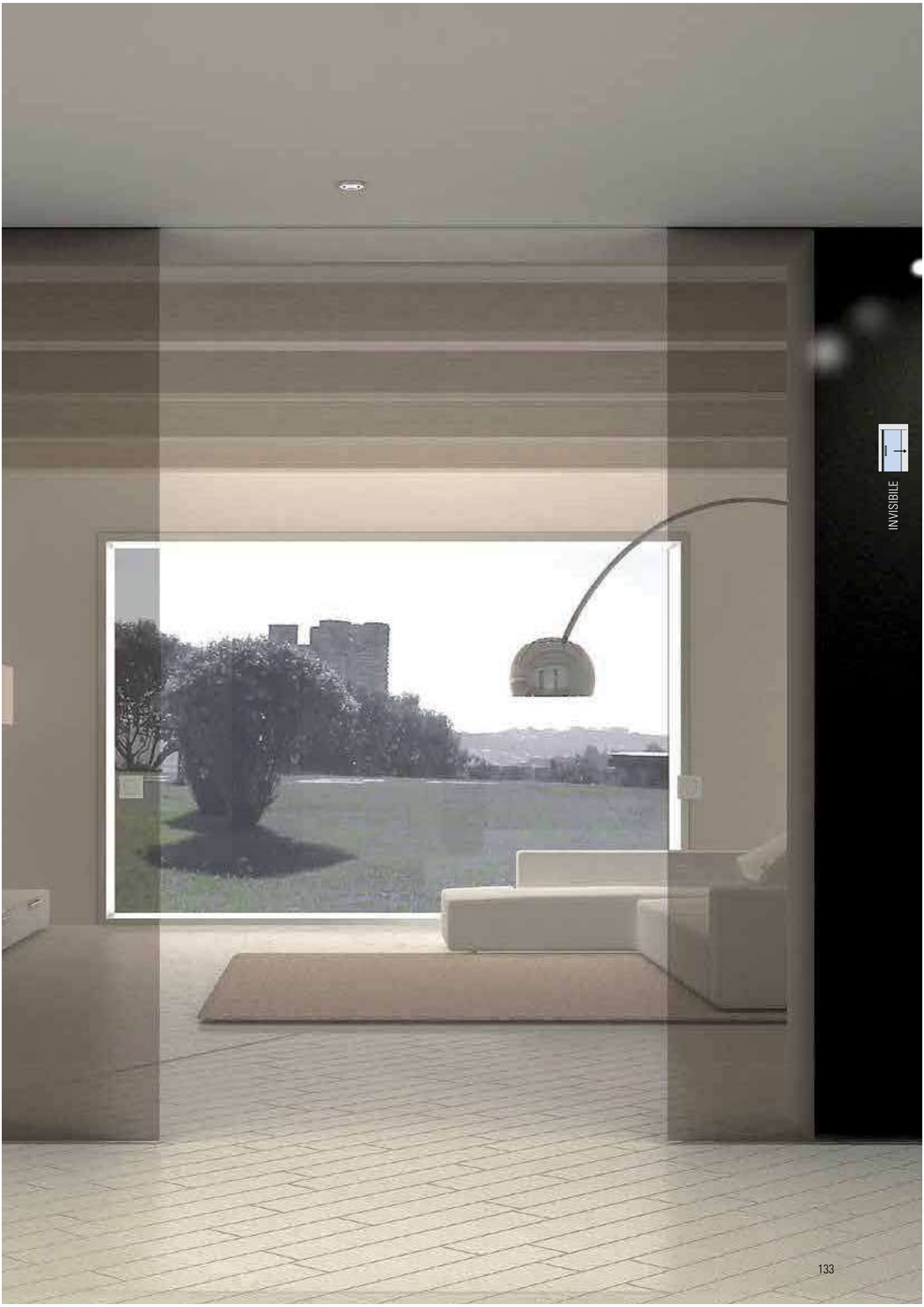

INVISIBLE

ACCESSORIES FRAMED DOORS

ZUBEHÖREN GERAHMTE TÜREN

FRAME=FILCO-FUSION
FRAMES / ANTE

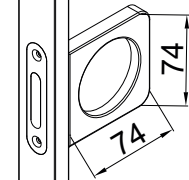
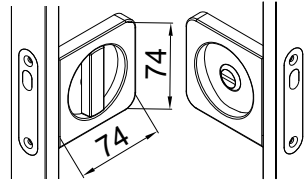

DIV-009

- Lock with hook for framed sliding door
 - Schloss mit Hakenriegel für gerahmte Schiebetür
- AN-IXO-NO-BI-BC-BS

DIV-009 2FLG

- Strike box for framed sliding door
 - Gegenkasten für gerahmte Schiebetür
- AN-IXO-NO-BI-BC-BS

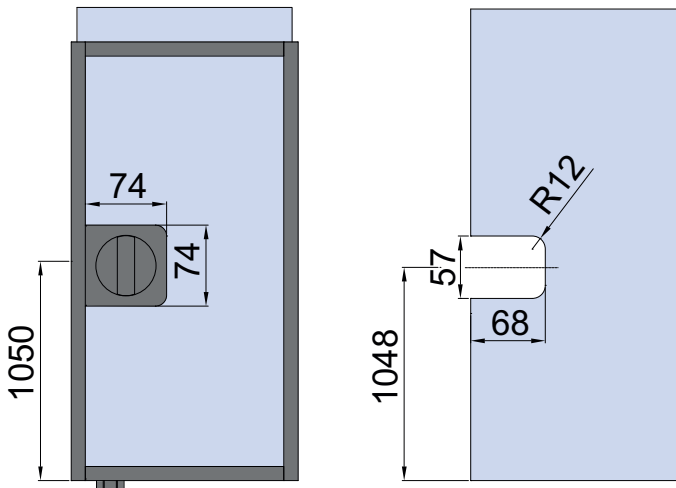

- Glass preparation for lock DIV-009 and strike box DIV-009 2FLG
- Glasbearbeitung für Schloss DIV-009 und Gegenkasten DIV-009 2FLG

xme595m/xme595r

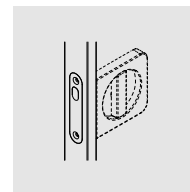
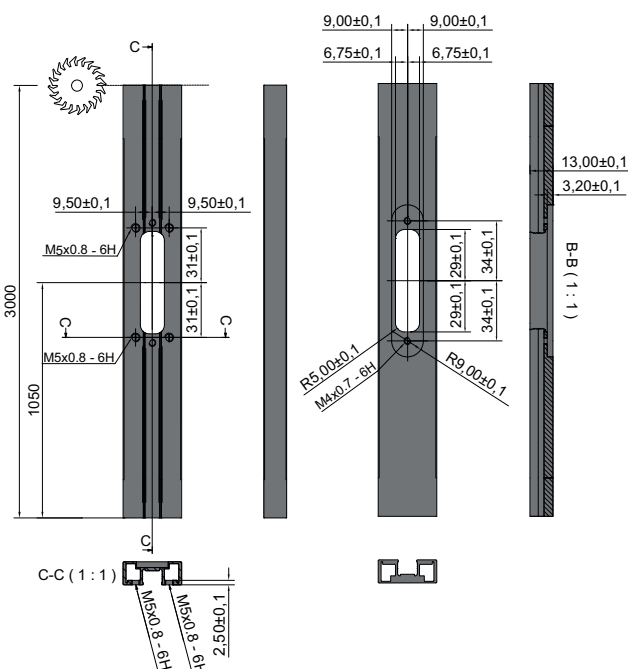

SET:

- Profiles for aluminium panel with machining for lock DIV-009 or strike box DIV-009 2FLG (not included)
- Flügelrahmen mit Bearbeitung für Schloss DIV-009 oder Gegenkasten DIV-009 2FLG (nicht enthalten)

FRAME:

DIV-SER-995 995 x 2980 mm

DIV-SER-1495 1495 x 2980 mm

FUSION:

FUS-SER-995 995 x 2980 mm

FUS-SER-1495 1495 x 2980 mm

xme595n

DIV-010

- Pull-lever for framed panel
- Stiringriff für gerahmte Tür CP-CR-IXO



1pc

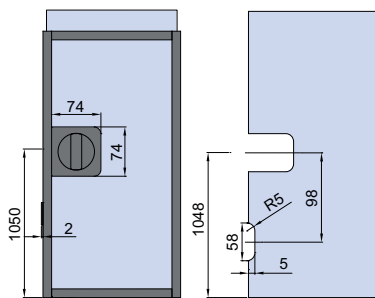
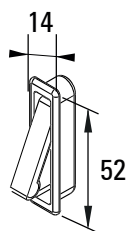

- Glass preparation for lock DIV-009 and pull-lever DIV-010
- Glasbearbeitung für Schloss DIV-009 und Stiringriff DIV-010

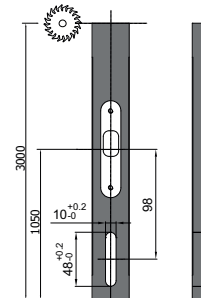
LAV-DIV-010

- Profile preparation for pull-lever DIV-010
- Profilbearbeitung für Stiringriff DIV-010

FUS-TS12

- Floor guide for FUSION panel with pocket system
- Bodenführung für FUSION Tür mit kastensystem



xme595r

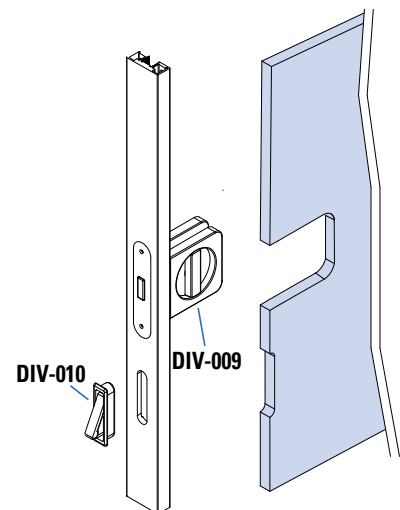

- PLEASE NOTE: double pocket sliding doors
- ACHTUNG: 2-flügelige Schiebetüren in der Wand laufend

- Strike box front-plate not recessed
- Gegenkasten Stulp nicht versenkt

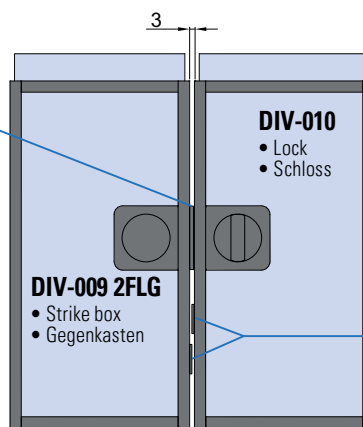

- Pull-levers not on same level for correct locking
- Stiringriffe nicht auf gleicher Ebene um Schloss zu Schliessen

xme595r

DIV-008

- Pair sliding door-handles with self-adhesive fixing
- Paar Griffmuscheln selbstklebend

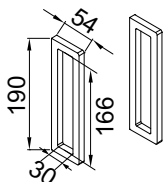
DIV-007

- Pair sliding door-handles with self-adhesive fixing
- Paar Griffmuscheln selbstklebend

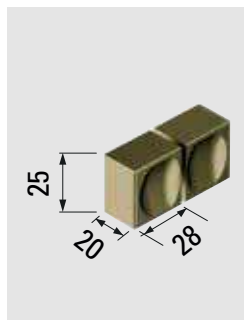
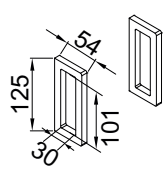
B-196

- Pair of doorknobs
- Paar Türkнопfe

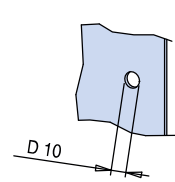
V-532-INC

- Pc sliding door-handle with self-adhesive fixing
- Stück Griffmuschel selbstklebend

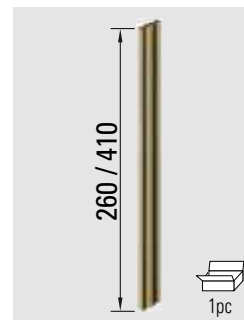
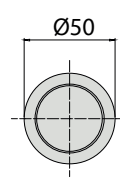
POR-0408V

- Pc pullhandle with self-adhesive fixing
- Stück Stossgriff selbstklebend



xme595m/xfb-139