

**INVISIBLE + FRAMES (OPTIONAL SOFT-CLOSE)**  
INVISIBLE TRACK PROFILES / UNSICHTBARE LAUFSCHIENEN



**DIV-7600**



**120 Kg**

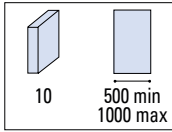

FRAME-FIL-O-FUSION  
FRAMES / ANTE

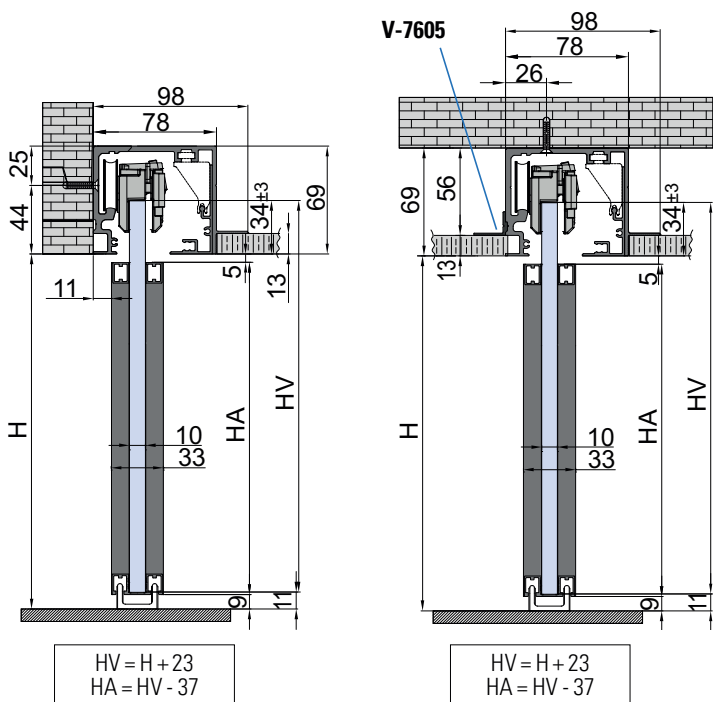
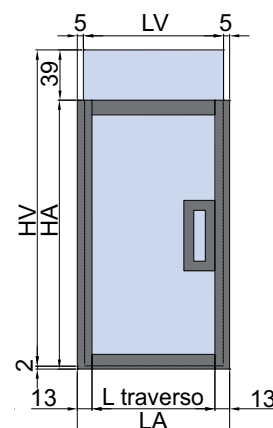

## COMPONENTS / EINZELTEILE ▶ 130

 FRAME-FIL-FUSION  
 FRAMES / ANTE

 FRAMED PANEL  
 GERÄHMTE TÜR

- Security glass holes **optional**
- Sicherheitsbohrungen **optional**

**DIV-7600 SET 1**

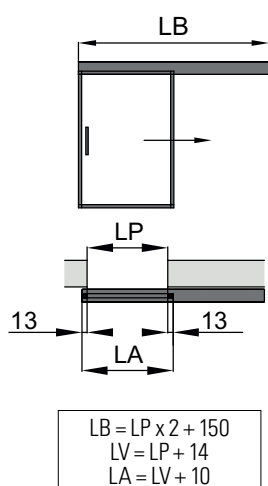
- Sliding door set with frames, wall/ceiling installation
- Schiebetürset für 1 flg, Wand-Deckenmontage mit Flügelrahmen

**DIV-7600 SET 2**

- Sliding doors set with frames, wall/ceiling installation
- Schiebetürset für 2 flg, Wand-Deckenmontage mit Flügelrahmen

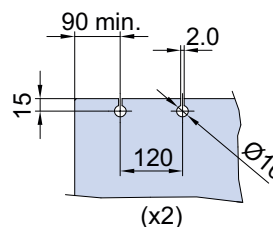
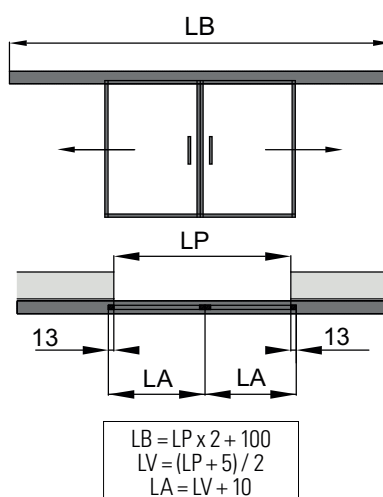

- Handles **optional**
  - Griffe **optional**
- page ▶ 65

xme595i

Components / Einzelteile ▶ 130	Fin. / Oberf.	DIV-7600 SET 1	DIV-7600-1,5 SET 1	DIV-7600 SET 2	DIV-7600-1,5 SET 2
<b>V-7600</b> L=2000 L=3000 L=4000 L=6000	AN	1	1	1	1
<b>V-7605</b> L=2000 L=3000 L=4000 L=6000 (OPTIONAL)	GR	(1)	(1)	(1)	(1)
<b>V-7602</b>	-	1	1	2	2
<b>V-5606-70 Kg / V-5606-80 Kg / V-5606-100 Kg / V-5606-120 Kg (OPTIONAL)</b>	-	(1)	(1)	(2)	(2)
<b>DIV-995</b> framed panel - gerahmte Tür 995 x 2980	AN / NO / IXO / BI / BC / BS	1	-	2	-
<b>DIV-1495</b> framed panel - gerahmte Tür 1495 x 2980	AN / NO / IXO / BI / BC / BS	-	1	-	2
<b>DIV-204</b> cross profile - Querprofil (OPTIONAL)	AN / NO / IXO / BI / BC / BS	(n)	(n)	(n)	(n)

## FRAMES

FRAMED PANEL / GERAHMTE TÜR



### FINISHING RANGE / OBERFLÄCHEN-SORTIMENT



**IX0**  
• Inox effect  
• Inox Effekt



**BC**  
• Light bronze  
• Hellbraun



**BS**  
• Dark bronze  
• Dunkelbraun



**AN**  
• Silver anodized  
• Aluminium Silberfarbig



**BI**  
• Matt white  
• Weiß matt



**NO**  
• Matt black  
• Schwarz matt

## PROFILE DIMENSION / PROFILGRÖSSE

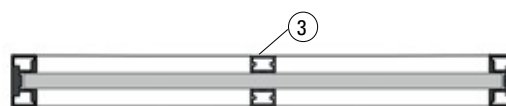

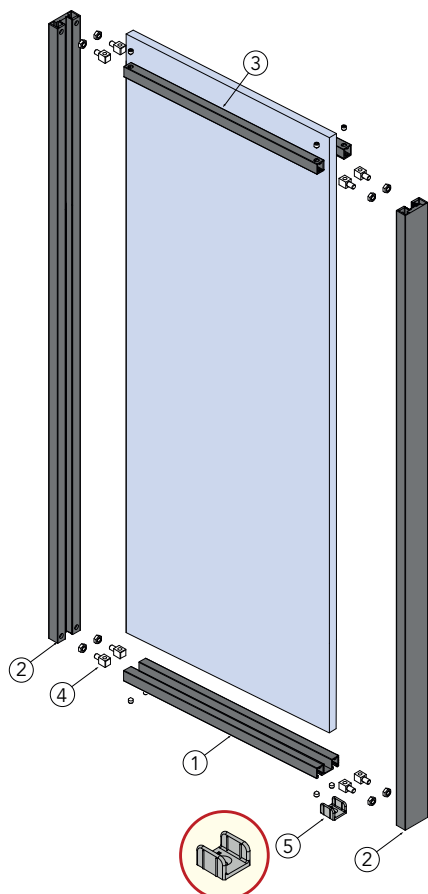
**PANEL SET**
**DIV-995** 995 x 2980 mm

**DIV-1495** 1495 x 2980 mm

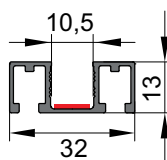
- ① **DIV-203**
- Horizontal bottom profile
  - Unterer Horizontalprofil

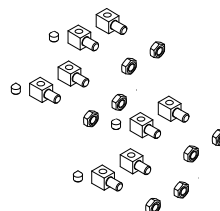

- ④ **P-F37**
- Assembly kit
  - Montage-Kit



- ② **DIV-202**
- Vertical profile
  - Vertikalprofil

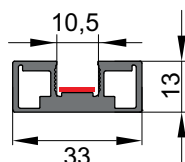

- ⑤ **DIV-012**
- Door guide
  - Bodenführung



- ③ **DIV-204**
- Cross profile
  - Querprofil

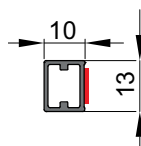

- ⑥ **DIV-01**
- Drilling template
  - Bohrschablone

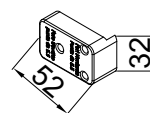

- Pre-installed double-side adhesive  
 • Selbstklebend

**SET FIXED PANEL**
**DIV-FIX-995** 995 x 2980 mm

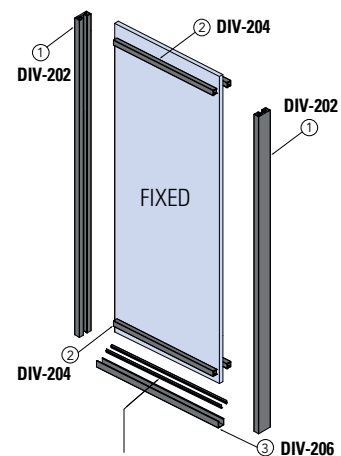
**DIV-FIX-1495** 1495 x 2980 mm

- Gaskets for DIV-206 included  
 • Dichtungen für DIV-206 enthalten

# FRAMES

## FRAMED PANEL / GERAHMTE TÜR

FRAME=FILO-FUSION  
FRAMES / ANTE

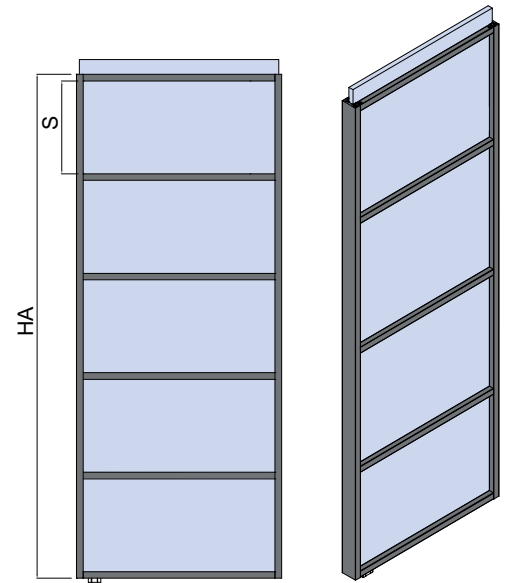

$$V = HA - (13 \times 6)$$

$$S = V / 5$$

- V and VL are values only for calculation
- V und VL sind Werte nur für die Berechnung

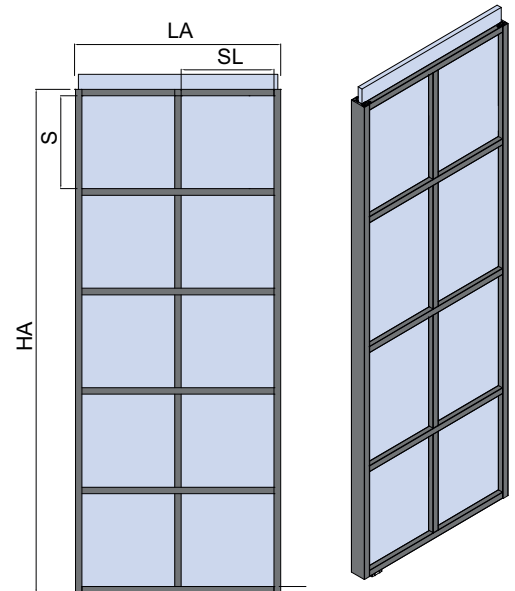

$$V = HA - (13 \times 6)$$

$$S = V / 5$$

$$VL = LA - 39$$

$$SL = VL / 2$$

**MY METALGLAS**

Configure your panel to calculate the cross profiles  
Konfigurieren Sie Ihre Tür und berechnen Sie automatisch die Querprofile



FRAME-FILO-FUSION  
FRAMES / ANTE

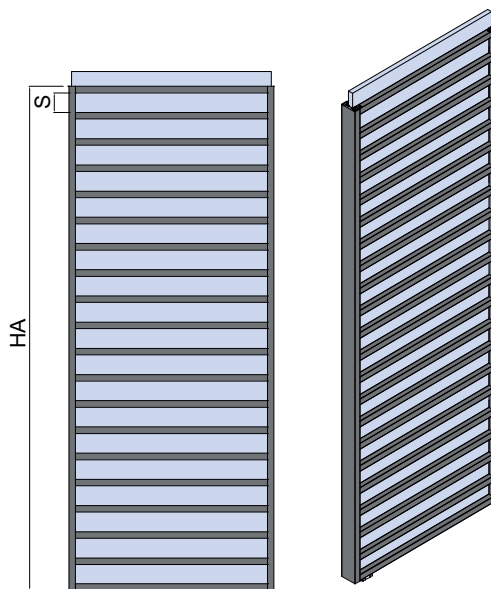

$$V = HA - (13 \times N)$$

$$S = V / (N - 1)$$

- N° cross profiles
- N° Querprofile

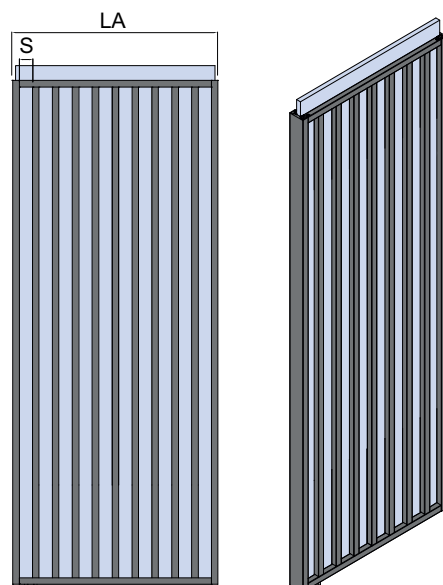

$$VL = LA - (13 \times N)$$

$$S = VL / (N - 1)$$

- N° vertical profiles
- N° Vertikalleisten

# INVISIBLE (OPTIONAL SOFT-CLOSE)

## INVISIBLE TRACK PROFILES / UNSICHTBARE LAUFSCHIENEN

### COMPONENTS / EINZELTEILE



#### V-7600

- Track profile with profile cover
  - Führungsschiene mit Profilabdeckung
- AN

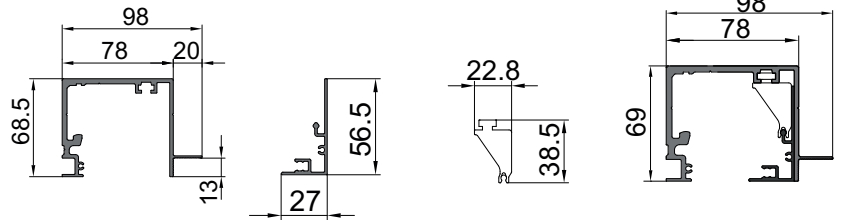

xme576f



#### V-7603

- Track profile for sliding panel and fixed side panel
  - Laufschiene für Schiebetür und Seitenteil
- AN

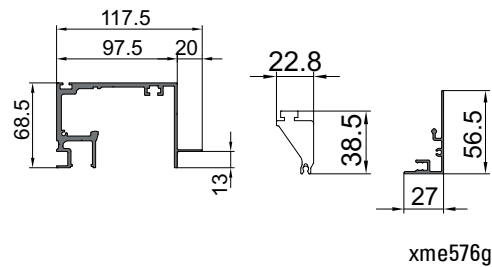

xme576g

OPTIONAL	
VP-019-MT	VP-018-MT
2	3
1000 mm - 2000 mm - 3000 mm	
<ul style="list-style-type: none"> <li>• Gaskets for fixed glass</li> <li>• Dichtungen für Seitenteil</li> </ul>	
8	10
12	

INVISIBLE



#### V-7605

- Profile for V-7600/V-7603 with support for suspended ceiling
  - Profil für V-7600/V-7603 mit Auflage für Abgehängter Decke
- GR

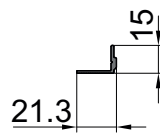

xme576g



#### V-7650

- Track profile with profile cover
  - Führungsschiene mit Profilabdeckung
- AN

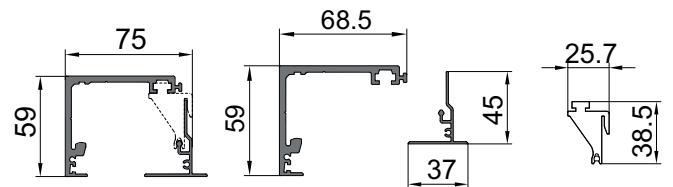

xme576e



#### V-7602

- Accessories set for 1 sliding panel consisting of:  
n° 2 roller carriers for 8/10 mm glass,  
n° 2 stoppers
- Zubehör für 1 Schiebetür bestehend aus:  
n° 2 Klemm - Laufwagen für 8/10 mm Glas,  
n° 2 Stopper

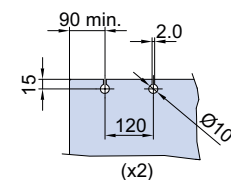
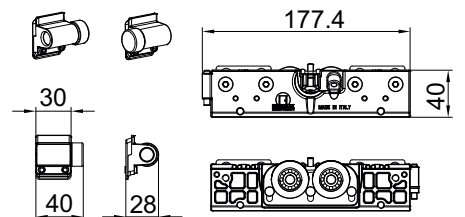

- Security glass holes **optional**
- Sicherheitsbohrungen **optional**

(x2)

xme576e

8-10	8,76/10,76/12,12,76/13,52 with/mit V-5607

- Adjustment from below
- Einstellung von unten



soft-close  
70 Kg

### V-5606-70

- Set 2 stoppers Soft-close (for 1 sliding panel)
- Set 2 Stoppers Soft-close mit Selbststeinzug (für 1 Schiebetür)

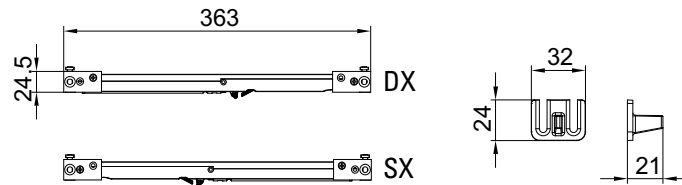

xme576d



soft-close  
80 Kg

### V-5606-80

- Set 2 stoppers Soft-close (for 1 sliding panel)
- Set 2 Stoppers Soft-close mit Selbststeinzug (für 1 Schiebetür)

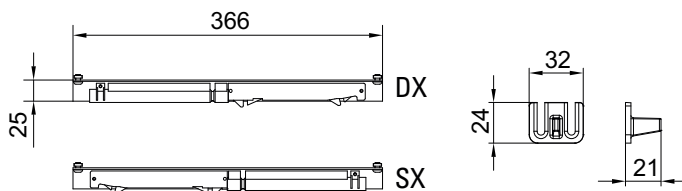

xme576d



100 Kg 120 Kg

### V-5606-100 100 KG V-5606-120 120 KG

- Set 2 stoppers Soft-close (for 1 sliding panel)
- Set 2 Stoppers Soft-close mit Selbststeinzug (für 1 Schiebetür)

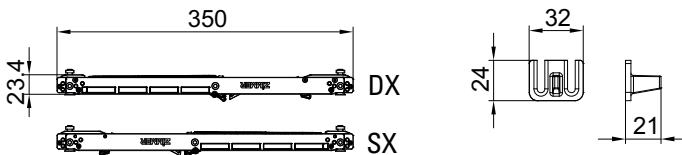

xme576d



### V-5607

- Set spacers for glass thickness 8.76 - 10.76 - 12 - 12.76 - 13.5 (for 2 clamps V-5602/V-5652/V-7602)
- Set Distanzscheiben für Glasdicke 8.76 - 10.76 - 12 - 12.76 - 13.5 (für 2 Klemm-Lauwagen V-5602/V-5652/V-7602)

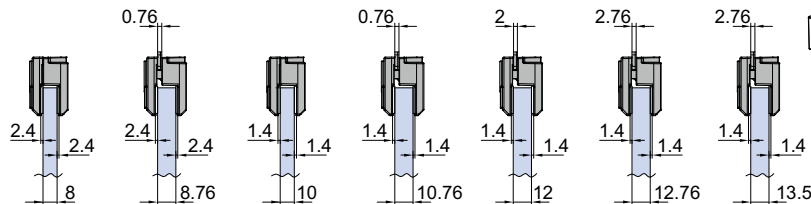
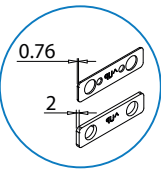

xme576i



### V-012-INS

- Floor guide adjustable for glass from 8 to 13,5 mm. Perfect for invisible and Telescopic
- Bodenführung verstellbar für Glas von 8 bis 13,5mm perfekt für invisibile und Teleskop Schiebe-Systeme, dank der Befestigungsplatte einsetzbar

AN - NS - CR

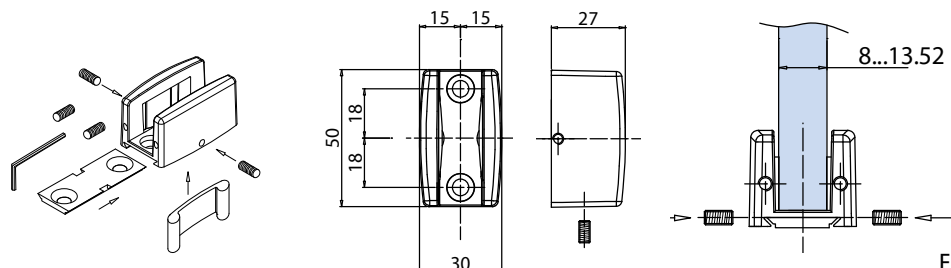

FB059-A

8-10-12  
12.5-13-13.5

INVISIBLE

# INVISIBLE + FRAMES (OPTIONAL SOFT-CLOSE)

## COMPONENTS / EINZELTEILE

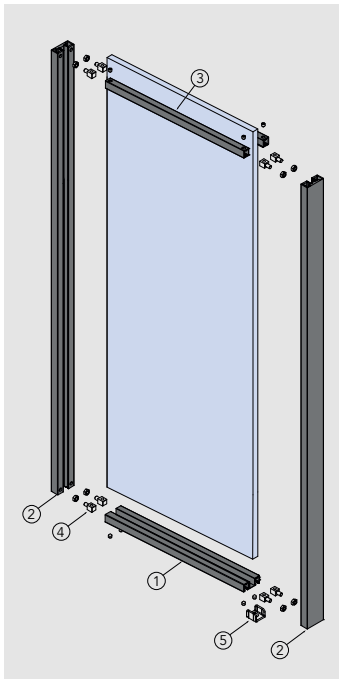

**PANEL SET**  
**DIV-995** 995 x 2980 mm  
**DIV-1495** 1495 x 2980 mm

① **DIV-203**  
 • Horizontal bottom profile  
 • Unterer Horizontalprofil

② **DIV-202**  
 • Vertical profile  
 • Vertikalprofil

③ **DIV-204**  
 • Cross profile  
 • Querprofil

④ **P-F37**  
 • Assembly kit  
 • Montage-Kit

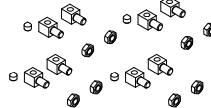
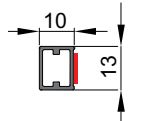
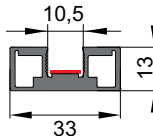
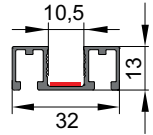

⑤ **DIV-012**  
 • Door guide  
 • Bodenführung



⑥ **DIV-01**  
 • Drilling template  
 • Bohrschablone

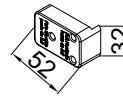

• Pre-installed double-side adhesive  
 • Selbstklebend

**SET FIXED PANEL**  
**DIV-FIX-995** 995 x 2980 mm  
**DIV-FIX-1495** 1495 x 2980 mm

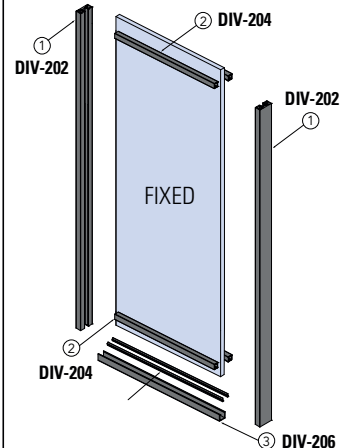

• Gaskets for DIV-206 included  
 • Dichtungen für DIV-206 enthalten

INVISIBLE

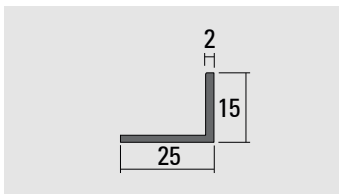

**V-7606**  
 • Support profile for suspended ceiling with profile DIV-205  
 • Profil mit Auflage für Abgehängter Decke mit Profil DIV-205  
 GR

V-7606



**DIV-205**  
 • Side profile for fixed framed panel FRAME with V-5600/V-7600 track profiles  
 • Seitenteilprofil für FRAME Flügelrahmen mit Laufschiene V-5600/V-7600

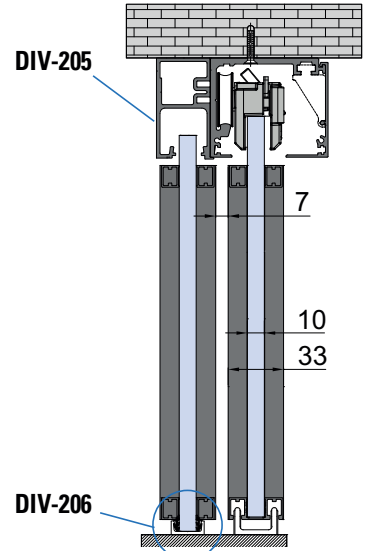
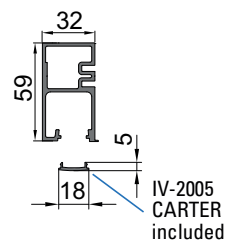

xme595m

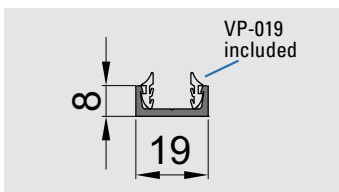

**DIV-206**  
 • Bottom "U" channel for fixed panel FRAME gaskets included  
 • Unteres "U" Profil für Seitenteil FRAME, Dichtungen enthalten  
 NO

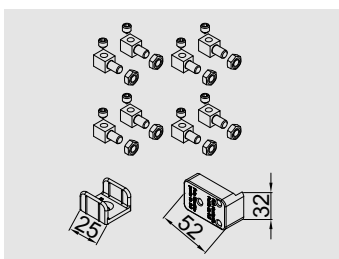

**DIV-KIT**  
 • Fixing materials and floor guide to assembly 1 framed panel FRAME  
 • Befestigungsmaterial und Bodenführung für 1 set Flügelrahmen FRAME

OPTIONAL		• Gaskets for fixed glass • Dichtungen für Seitenteil
VP-019-MT	VP-018-MT	
2	3	
1000 mm		
2000 mm		
3000 mm		

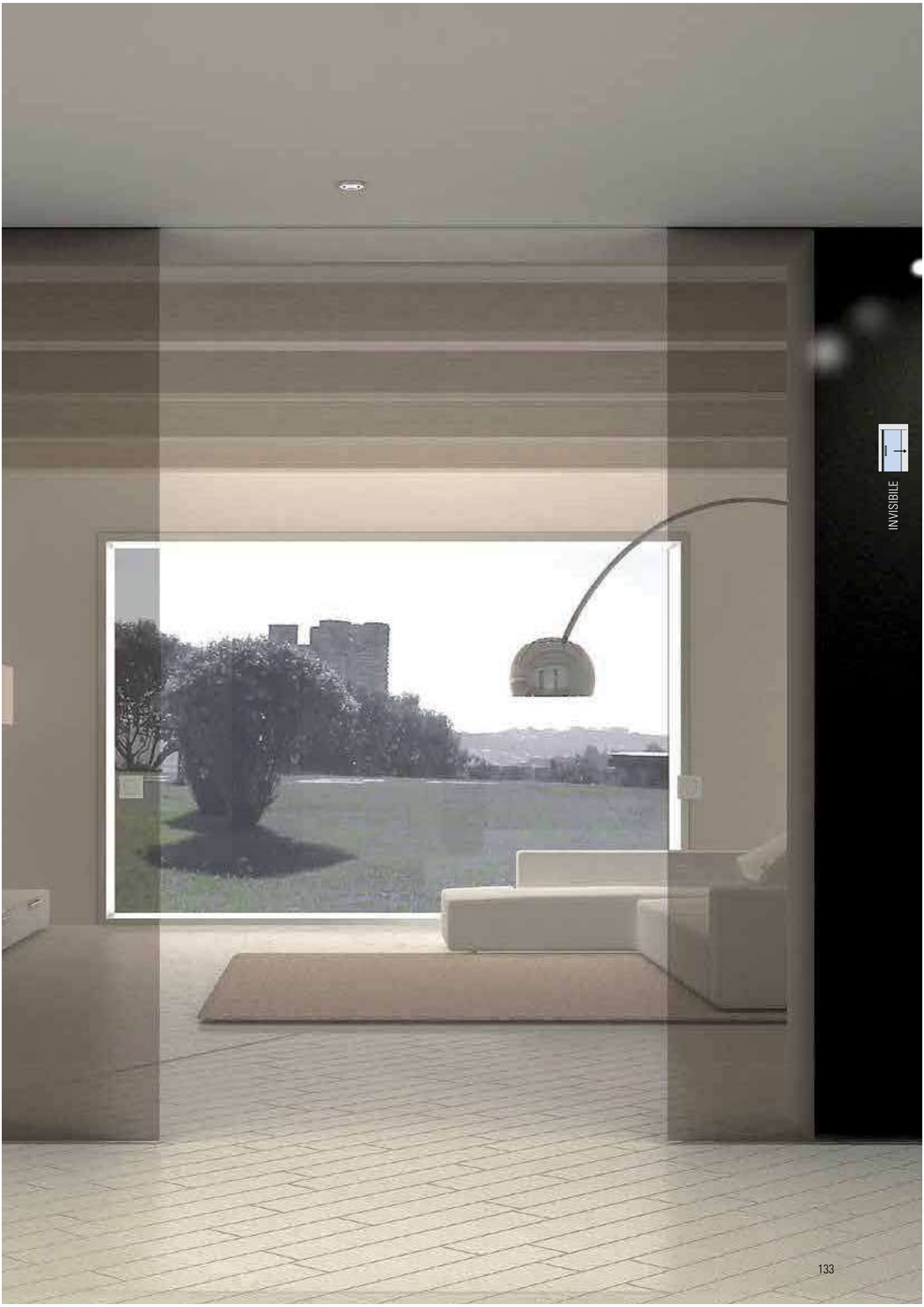

INVISIBLE

# ACCESSORIES FRAMED DOORS

## ZUBEHÖREN GERAHMTE TÜREN

FRAME=FILCO-FUSION  
FRAMES / ANTE

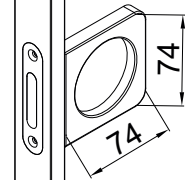
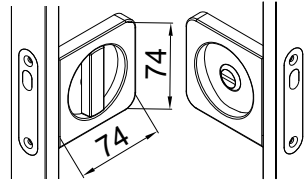

### DIV-009

- Lock with hook for framed sliding door
  - Schloss mit Hakenriegel für gerahmte Schiebetür
- AN-IXO-NO-BI-BC-BS

### DIV-009 2FLG

- Strike box for framed sliding door
  - Gegenkasten für gerahmte Schiebetür
- AN-IXO-NO-BI-BC-BS

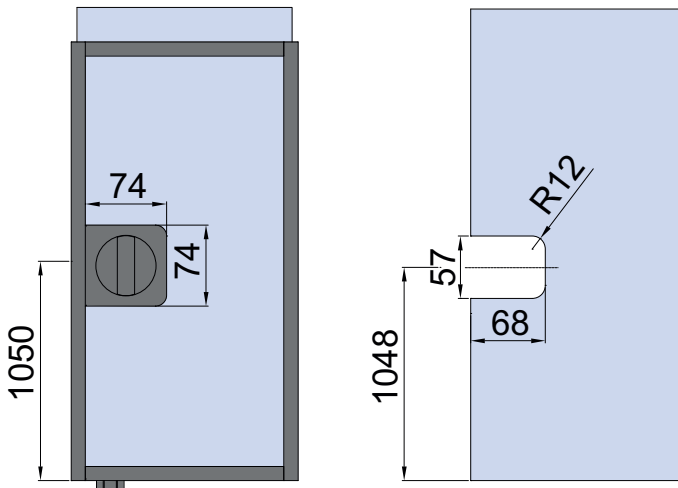

- Glass preparation for lock DIV-009 and strike box DIV-009 2FLG
- Glasbearbeitung für Schloss DIV-009 und Gegenkasten DIV-009 2FLG

xme595m/xme595r

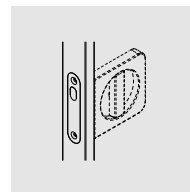
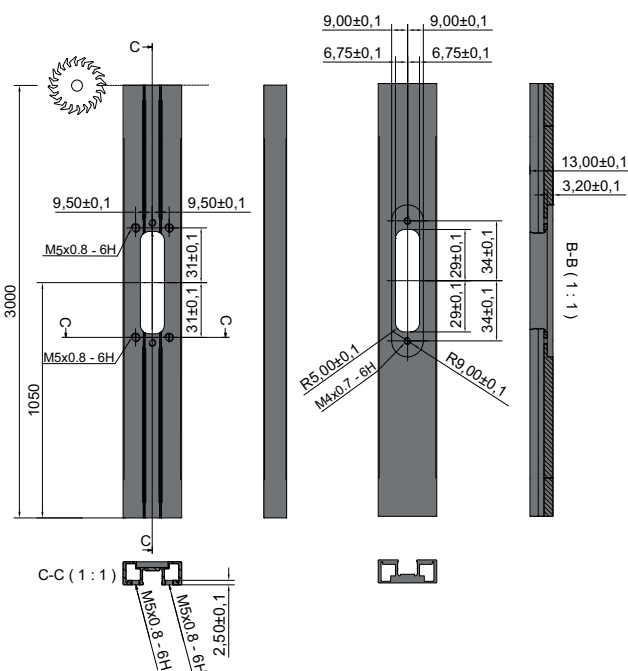

### SET:

- Profiles for aluminium panel with machining for lock DIV-009 or strike box DIV-009 2FLG (not included)
- Flügelrahmen mit Bearbeitung für Schloss DIV-009 oder Gegenkasten DIV-009 2FLG (nicht enthalten)

### FRAME:

**DIV-SER-995** 995 x 2980 mm

**DIV-SER-1495** 1495 x 2980 mm

### FUSION:

**FUS-SER-995** 995 x 2980 mm

**FUS-SER-1495** 1495 x 2980 mm

xme595n

**DIV-010**

- Pull-lever for framed panel
- Stirngriff für gerahmte Tür CP-CR-IXO



1pc

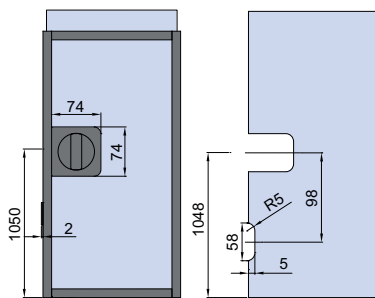
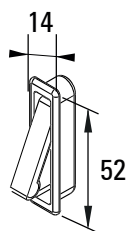

- Glass preparation for lock DIV-009 and pull-lever DIV-010
- Glasbearbeitung für Schloss DIV-009 und Stirngriff DIV-010

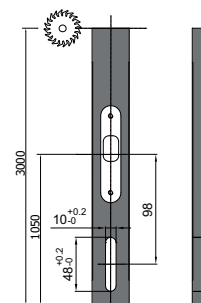

**LAV-DIV-010**

- Profile preparation for pull-lever DIV-010
- Profilbearbeitung für Stirngriff DIV-010

**FUS-TS12**

- Floor guide for FUSION panel with pocket system
- Bodenführung für FUSION Tür mit kastensystem

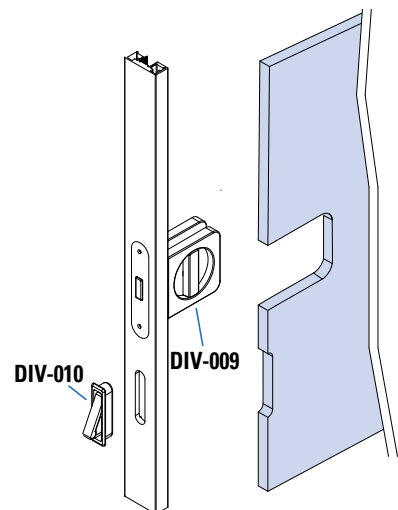
xme595r



- PLEASE NOTE: double pocket sliding doors
- ACHTUNG: 2-flügelige Schiebetüren in der Wand laufend

- Strike box front-plate not recessed
- Gegenkasten Stulp nicht versenkt

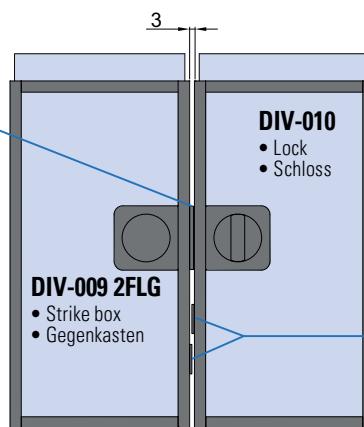

- Pull-levers not on same level for correct locking
- Stirngriffe nicht auf gleicher Ebene um Schloss zu Schliessen

xme595r

**DIV-008**

- Pair sliding door-handles with self-adhesive fixing
- Paar Griffmuscheln selbstklebend

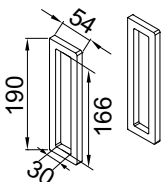
**DIV-007**

- Pair sliding door-handles with self-adhesive fixing
- Paar Griffmuscheln selbstklebend

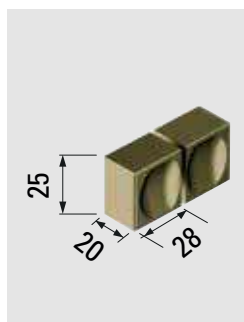
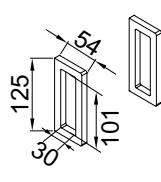
**B-196**

- Pair of doorknobs
- Paar Türkнопfe

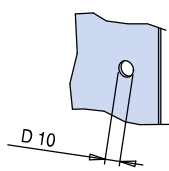
**V-532-INC**

- Pc sliding door-handle with self-adhesive fixing
- Stück Griffmuschel selbstklebend

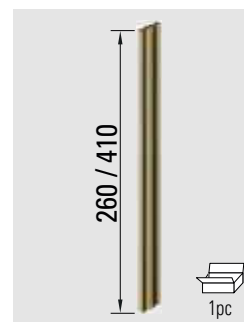
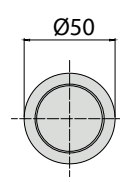
**POR-0408V**

- Pc pullhandle with self-adhesive fixing
- Stück Stossgriff selbstklebend



xme595m/xfb-139