



DIV-010 € S.246

- Tirante per anta intelaiata
- Pull-lever for framed panel
- Stirngriff für gerahmte Tür CP-CR-IXO



1pc

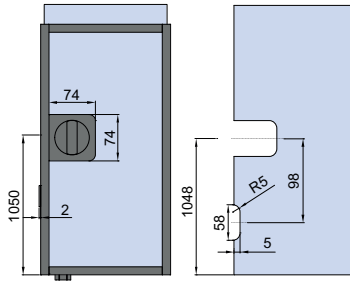
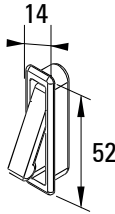

- Lavorazione vetro per serratura DIV-009 e nicchia a tirare DIV-010 per scorrevole a scomparsa
- Glass preparation for lock DIV-009 and pull-lever DIV-010
- Glasbearbeitung für Schloss DIV-009 und Stirngriff DIV-010

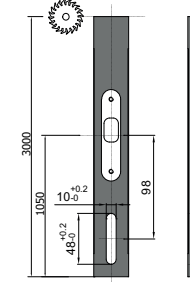

LAV-DIV-010 € S.247

- Lavorazione montante per nicchia a tirare DIV-010 per scorrevole a scomparsa
- Profile preparation for pull-lever DIV-010
- Profilbearbeitung für Stirngriff DIV-010



FUS-TS12 € S.242

- Guida a pavimento per anta FUSION con controlaio a scomparsa
- Floor guide for FUSION panel with pocket system
- Bodenführung für FUSION Tür mit kastensystem



xme595r

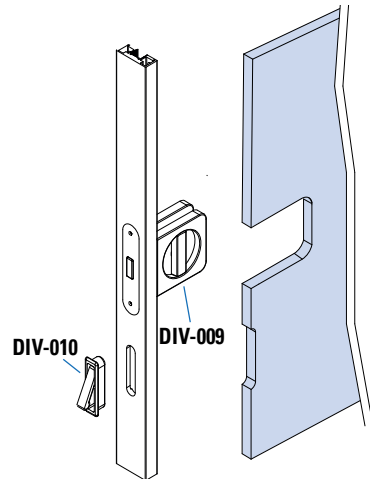

- ATTENZIONE: in caso di doppia anta scorrevole a scomparsa
- PLEASE NOTE: double pocket sliding doors
- ACHTUNG: 2-flügelige Schiebetüren in der Wand laufend

- Frontalino non incassato contro serratura
- Strike box front-plate not recessed
- Gegenkasten Stulp nicht versenkt

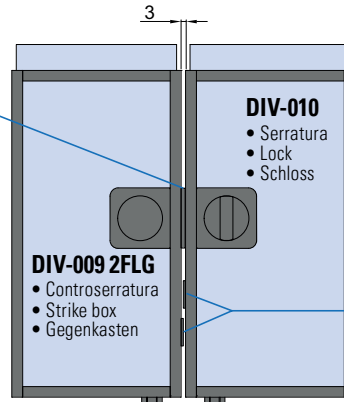

- Nicchia a tirare da sfalsare per poter chiudere la serratura
- Pull-levers not on same level for correct locking
- Stirngriffe nicht auf gleicher Ebene um Schloss zu Schliessen

xme595r



DIV-008 € S.249

- Paio nicchie scorrevole ad incollaggio
- Pair sliding door-handles with self-adhesive fixing
- Paar Griffmuscheln selbstklebend
- AN-IXO-NO-BI-BC-BS-CR

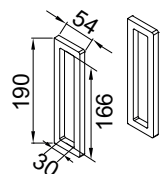

DIV-007 € S.248

- Paio nicchie scorrevole ad incollaggio
- Pair sliding door-handles with self-adhesive fixing
- Paar Griffmuscheln selbstklebend
- AN-IXO-NO-BI-BC-BS-CR

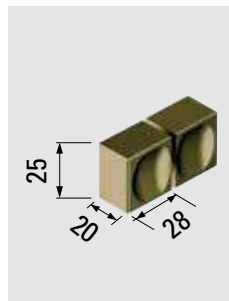
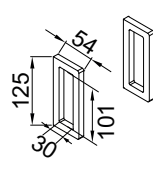

B-196 € S.252

- Paio pomoli
- Pair of doorknobs
- Paar Türknöpfe
- CR-NS-NO

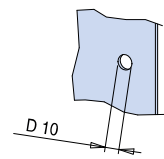

V-532-INC € S.251

- Pezzo nicchia tonda ad incollaggio
- Pc sliding door-handle with self-adhesive fixing
- Stück Griffmuschel selbstklebend
- AN-NS-NO-BI

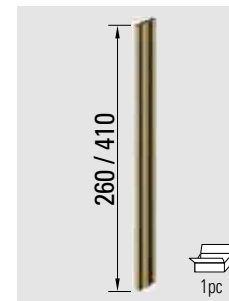
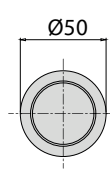

POR-0408V € S.250

- Maniglione singolo con biadesivo
- Pc pullhandle with self-adhesive fixing
- Stück Stossgriff selbstklebend
- AN-IXO-BC-BS-NO-BI-AL-CR



xme595m/xfb-139