

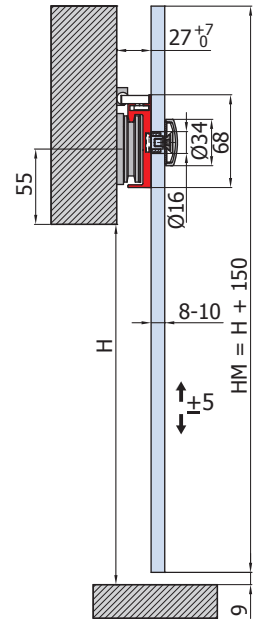

INDEPENDENT

V-8000

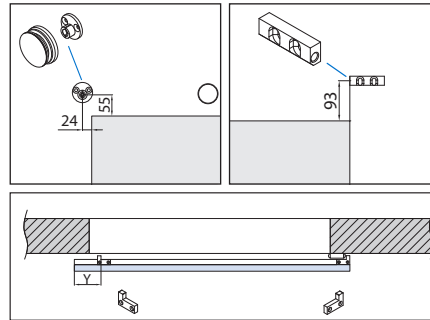
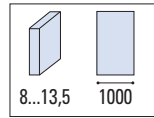

V-8000 SET 1

- Sliding door set, wall installation
- Schiebetürset 1-flügelig, Wandmontage

V-8000 SET 2

- Sliding doors set, wall installation
- Schiebetürset 2-flügelig, Wandmontage

GLASS PREPARATION GLASBEARBEITUNG

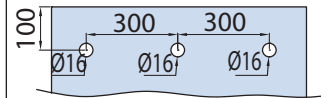

TECHNICAL

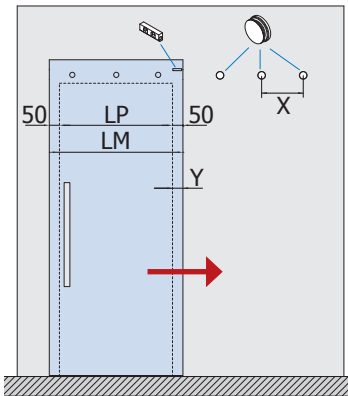

$$LM = LP + 100$$

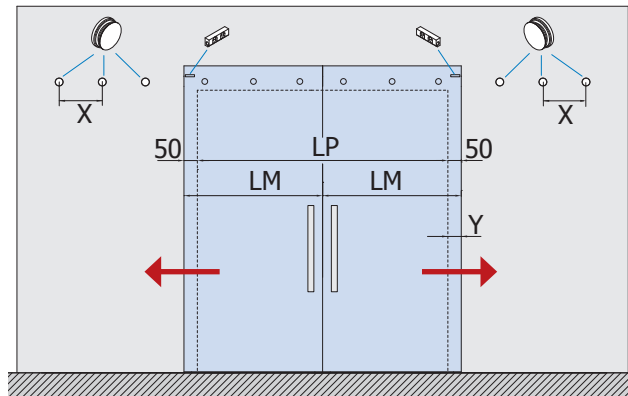

$$LM = (LP + 100) / 2$$

xme249a

COMPONENTS / EINZELTEILE ▶ 154



V-8000



V-8001



V-8002



V-012

Cod.	Fin. / Oberf.	V-8000 SET 1	V-8000 SET 2
V-8000 L=1000 L=1400	IX	1	2
V-8001	NS / CR	1	2
V-8002	NS / CR	1	2
V-012	NS / CR	1	2
V-8005 L= >1100	NS / CR	1 extra x 140 mm	1 extra x 140 mm

V-8000 / V-8100 / V-8050 / V-8040 INDEPENDENT COMPONENTS / EINZELTEILE

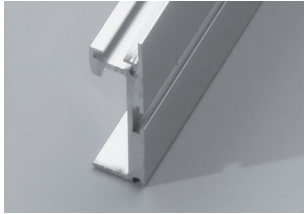

- V-8000**
- Independent track profile
 - Laufschiene Independent

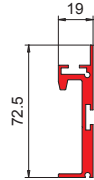

Cod.	Fin. / Oberf.
V-8000-1000 mm	IXE
V-8000-1400 mm	IXE

xfb-064

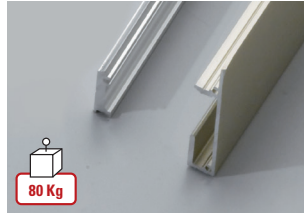

- V-8100**
- Cover profile for Independent track profile
 - Profilabdeckung für Laufschiene Independent

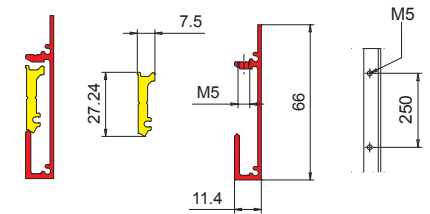
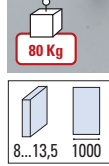

Cod.	Fin. / Oberf.
V-8100-1000 mm	IXE / CR
V-8100-1400 mm	IXE / CR

xfb-064



- V-8002**
- Set 7 pcs rollers and stopper for 1 panel
 - Set 7 Stk Laufrollen und Stopper für 1 Flügel
- NS - CR

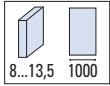

- V-8005**
- Roller
 - Laufrolle
- NS - CR

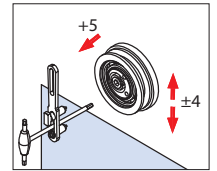
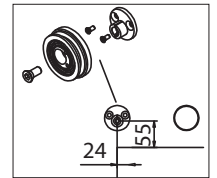
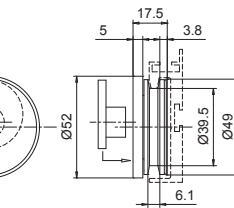
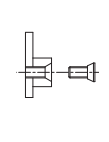

xfb-064



- V-8001**
- Set 3 pcs fixing points for 1 panel for system V-8000
 - Set 3 Stk Punkthalterungen für 1 Flügel für System V-8000
- NS - CR

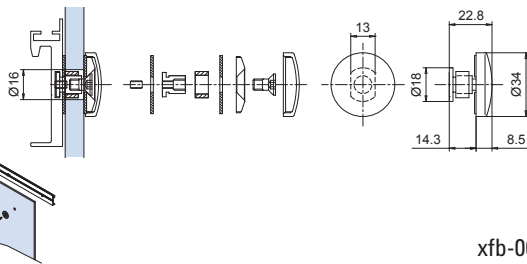
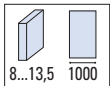

xfb-064



- V-8051**
- Set 3 pcs fixing points for 1 panel for system V-8050
 - Set 3 Stk Punkthalterungen für 1 Flügel für System V-8050

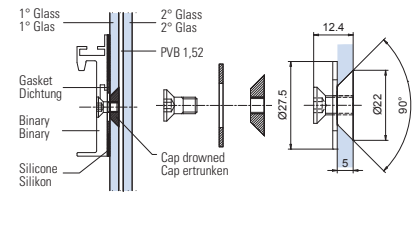
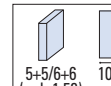

xfb-064

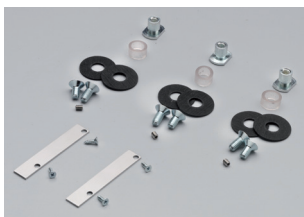

- V-8101**
- Set 3 pcs fixing points for 1 panel and endcaps for cover profile V-8100
 - Set 3 Stk Punkthalterungen für 1 Flügel und Endkappen für Abdeckung V-8100
- IX - CR

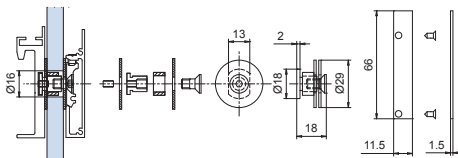
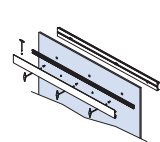

xfb-064



- V-8006**
- Stopper for 1 panel
 - Stopper für 1 Flügel

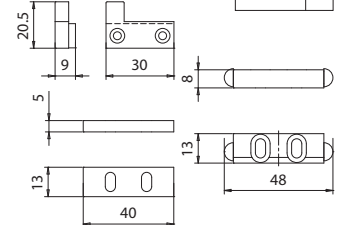
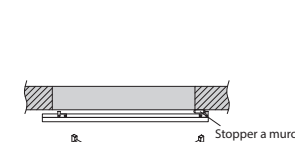

xfb-064

TECHNICAL



TECHNICAL

INDEPENDENT
V-8050
▶ 152