

B-7500 SMARTONE / B-7500-G SMARTONE

▶ H.01

- Balastra semiregolabile.
Optional supporti LED.
- Adjustable railing system.
Optional LED supports.
- Verstellbares
Ganzglasgeländer System.
Optional LED Auflage.

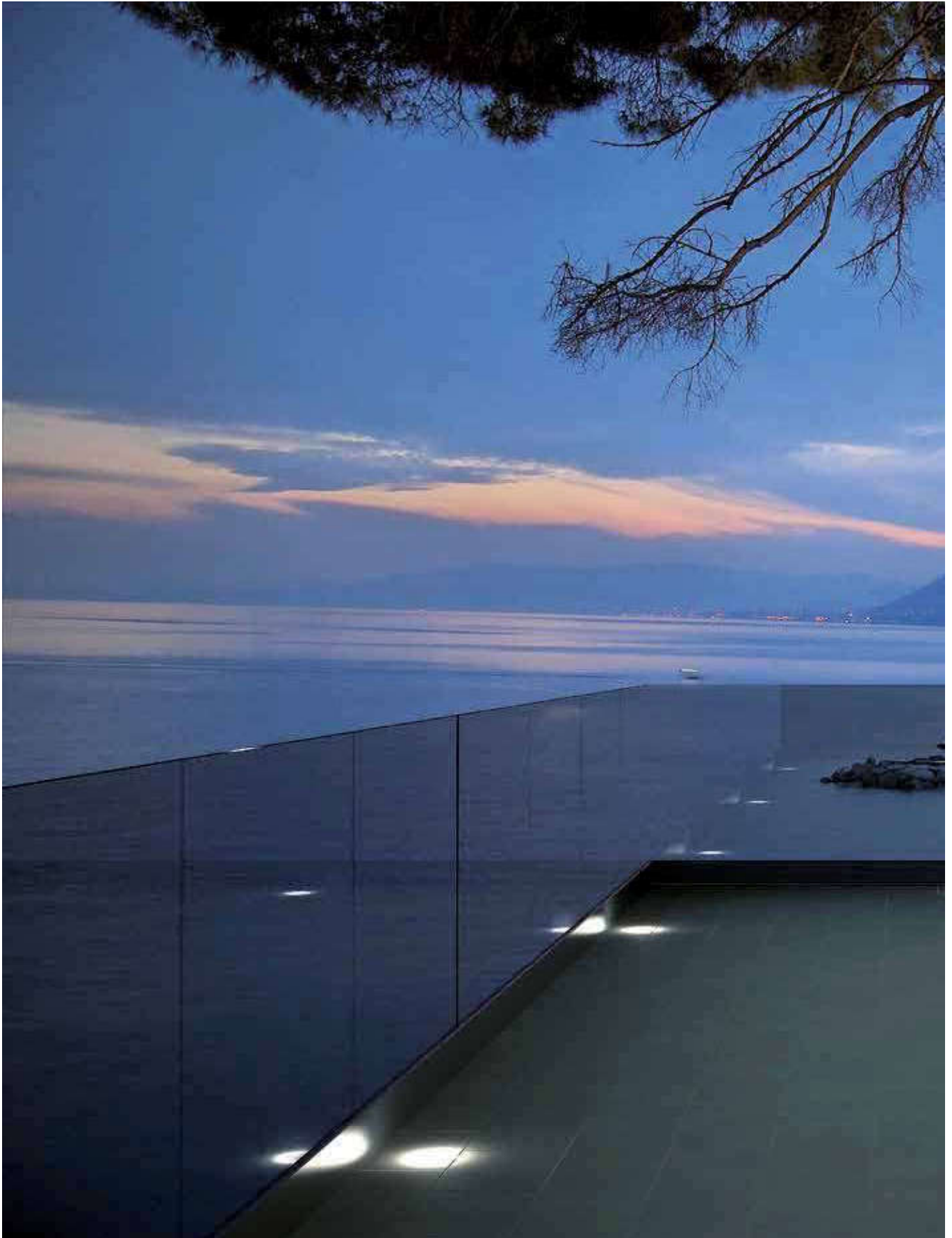

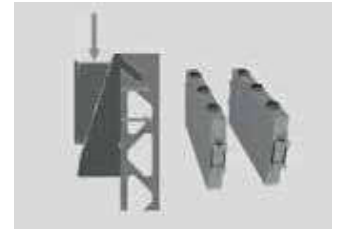

KIT SMARTONE 2

- Passa dalla regolazione singola alla doppia quando vuoi
- Switch from the single to the double regulation whenever you want
- Auf Wunsch kann jederzeit von der Einzelregulierung auf die Doppelregulierung übergegangen werden

COMPONENTI / COMPONENTS / EINZELTEILE

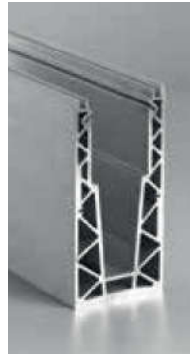
- B-7500+B-6001-CF2**
- Profilo balastra + 2 velette
 - Railing profile + 2 cover profiles
 - Profil für Geländer mit 2 Abdeckungen



- B-7500-G**
- Profilo balastra grezzo
 - Raw Railing profile
 - Roh Profil für Geländer



- B-6001-CF2 / B-6051-CF2**
- Velette
 - Cover profiles
 - Abdeckungen



- B-SET-SMART-8 / B-SET-SMART-10 / B-SET-SMART-12**
- Set morsetti e guarnizioni
 - Set clamps and gaskets
 - Set Klemmen und Dichtungen

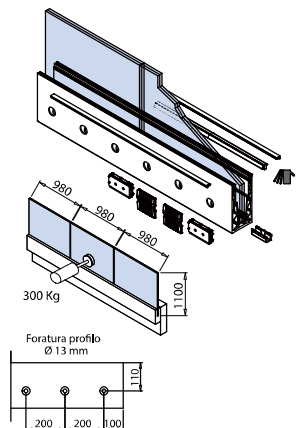
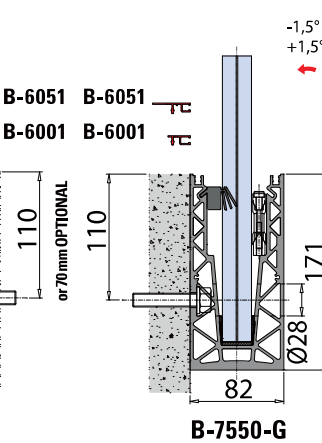
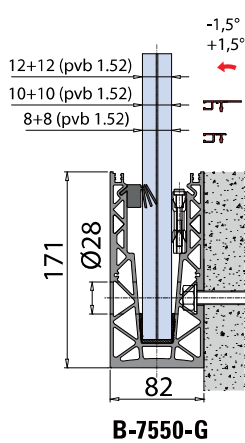
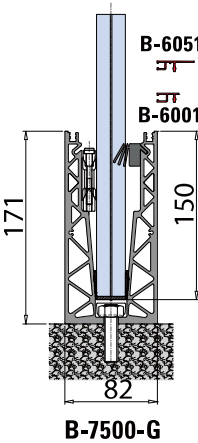
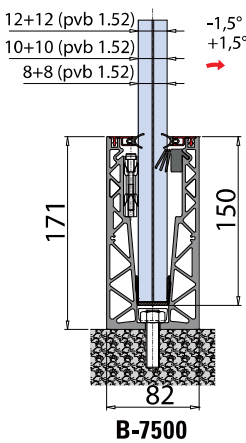

fb041p150/151

Set completo/mt L-3000 mm Complete set/mt L-3000 mm Komplett-Set L-3000 mm	FIN. FIN. OB.	Vetro Glass Glas	Morsetti/mt Clamps/mt Klemmen/ftm	Testato spinta Test side force Getestete Seitenkraft	Classe Class II Klasse	Testato Tested Bestätigte horizontale Nutzlast	Deflection
B-7500 SET 1,5 KN 8	AN	8+8 1,52 pvb	2	150 kg	1	1 kN/m = 100 kg/m	
B-7500 SET 3 KN 10	AN	10+10 1,52 pvb	2	300 kg	2	2 kN/m = 200 kg/m	
B-7500 SET 4,5 KN 12	AN	12+12 1,52 pvb	4	450 kg	3	3 kN/m = 300 kg/m	
*B-7500-G SET 1,5 KN 8	GR	8+8 1,52 pvb	2	150 kg	1	1 kN/m = 100 kg/m	
*B-7500-G SET 3 KN 10	GR	10+10 1,52 pvb	2	300 kg	2	2 kN/m = 200 kg/m	
*B-7500-G SET 4,5 KN 12	GR	12+12 1,52 pvb	4	450 kg	3	3 kN/m = 300 kg/m	
*B-7550-G SET 1,5 KN 8	GR	8+8 1,52 pvb	2	150 kg	1	1 kN/m = 100 kg/m	
*B-7550-G SET 3 KN 10	GR	10+10 1,52 pvb	2	300 kg	2	2 kN/m = 200 kg/m	
*B-7550-G SET 4,5 KN 12	GR	12+12 1,52 pvb	4	450 kg	3	3 kN/m = 300 kg/m	
B-7500-0,8CH-12	AN	12+12 1,52 pvb	2	240 kg	A,B,D,E,F,G, C	1,6 kN/m = 160 kg/m	21,5 mm
*B-7500-G-CH-12	GR	12+12 1,52 pvb	2	240 kg	A,B,D,E,F,G, C	1,6 kN/m = 160 kg/m	21,5 mm
*B-7550-G-CH-12	GR	12+12 1,52 pvb	2	120 kg	A,B,D,E,F,G	0,8 kN/m = 80 kg/m	17 mm

* senza velette / without cover profiles / ohne Abdeckungen