

# SC-135 SMALL SCREEN *A PEZZI / IN PIECES / IN TEILE*

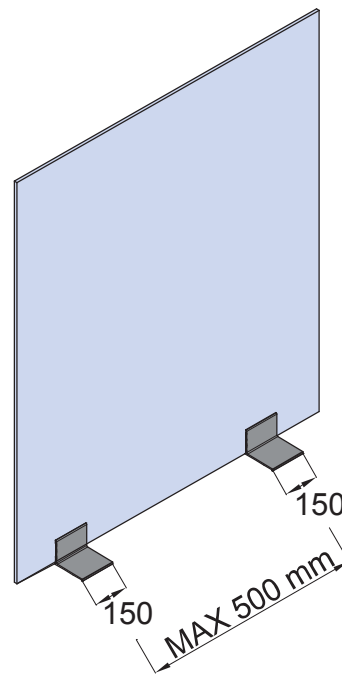

XME585B

## Componenti / Components / Einzelteile

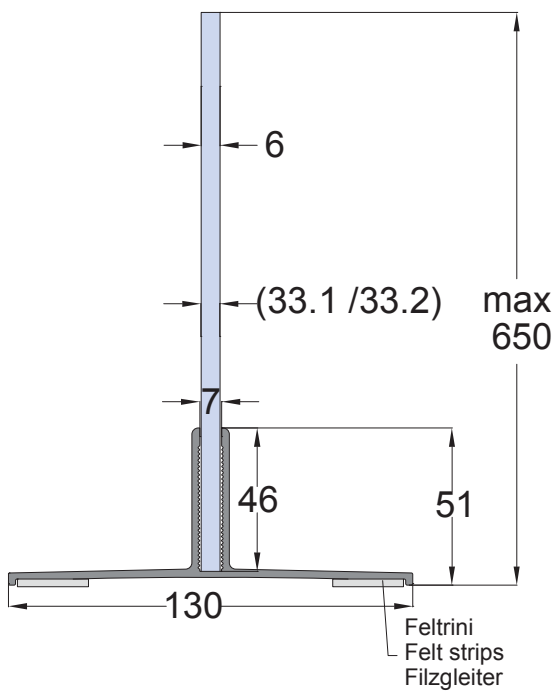

Cod.	Fin./Fin./Oberf.
SC-135 150 mm	AN

### SC-135

- Profilo e feltrini
- Profile and felt strips
- Profil mit Filzgleiter



## Scheda di assemblaggio / Assembly sheet / Montageblatt

### Con silicone / with silicone / mit Silikon

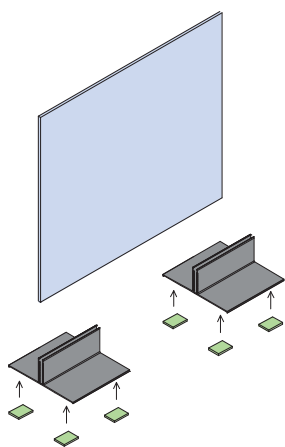

- Applicare feltri alla base del profilo, per maggiore sicurezza si consiglia di applicare anche il biadesivo
  - Attach the felt strips under the base, for more safety it is recommended to apply also the double-sided tape
  - Befestigen die Filzgleiter unter Profil. Für mehr Sicherheit wird empfohlen, auch das doppelseitige Klebeband anzubringen



#### SC-131

- Biadesivo 10 mt, spessore 1 mm
- Double-sided tape 10 m, 1 mm thickness
- Doppelseitiges Klebeband 10 m, 1 mm Dicke

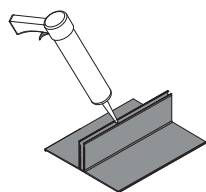

- Siliconare nella cava del profilo
  - Inject some silicone inside the channel
  - Silikon in das Profil einspritzen

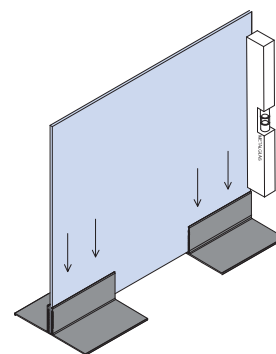

- Posizionare e infilare il vetro, controllare che il vetro sia a squadra
  - Arrange and insert the panel, check the alignment
  - Die Scheibe anbringen und einführen, Ausrichtung prüfen

### Con biadesivo / with double-sided tape / mit doppelseitigem Klebeband

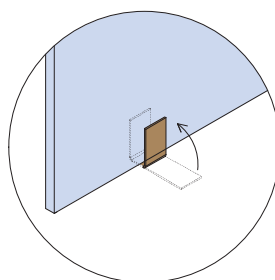

- Applicare le strisce di biadesivo (SC-131 non incluso) sul vetro e rimuovere la pellicola
  - Apply double-sided adhesive strips (SC-131 not included) and remove the film
  - Zur Befestigung von Klebestreifen das Klebeband abziehen und die selbstklebende Rückseite montieren (SC-131 nicht enthalten)

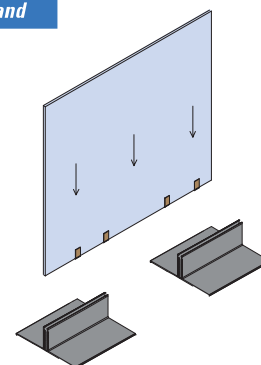
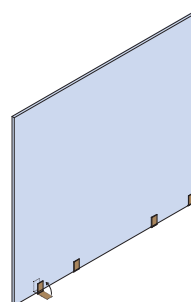

- Posizionare e infilare il vetro
  - Arrange and insert the panel
  - Die Scheibe anbringen und einführen