

SC-130 SMALL SCREEN

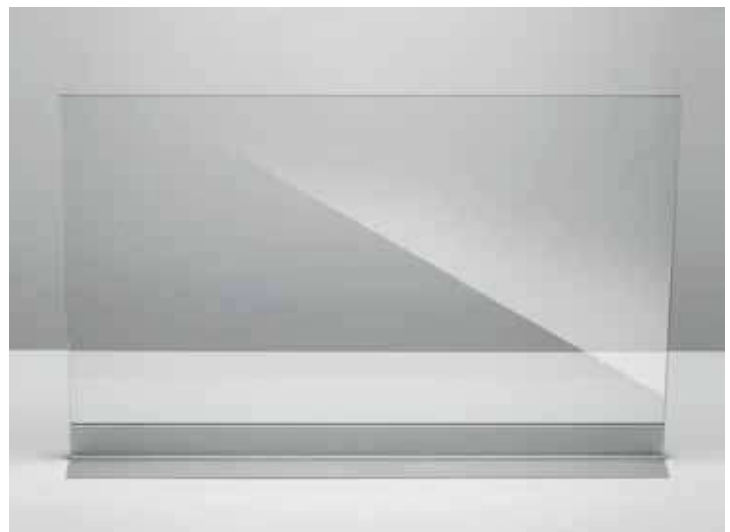

XME585A

Componenti / Components / Einzelteile

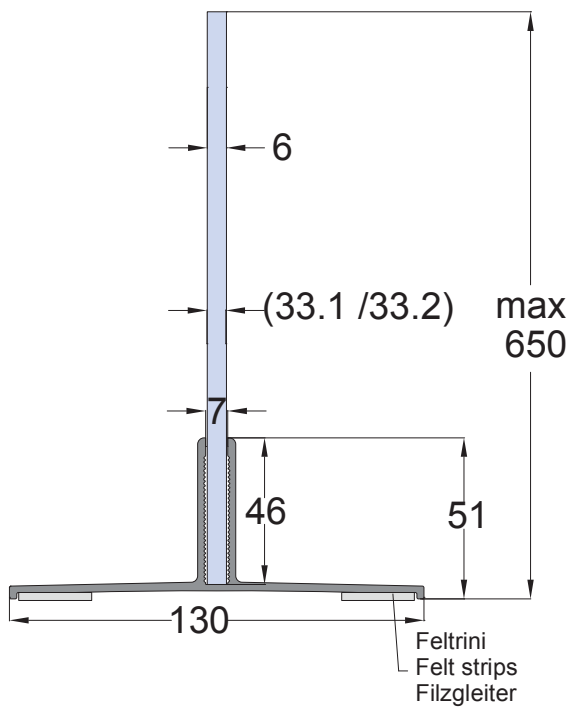

Cod.	Fin./Fin./Oberf.
SC-130 FIX 3000 mm	AN / GR
SC-130*	AN / GR

* disponibilità taglio a misura mm 500→3000
 * cut to size mm 500→3000
 * nach Mass geschnitten mm 500→3000

SC-130

- Profilo e feltrini
- Profile and felt strips
- Profil mit Filzgleiter

SC-136 (optional)

- Tappo
- Endcap
- Endkappe



Scheda di assemblaggio / Assembly sheet / Montageblatt

Con silicone / with silicone / mit Silikon

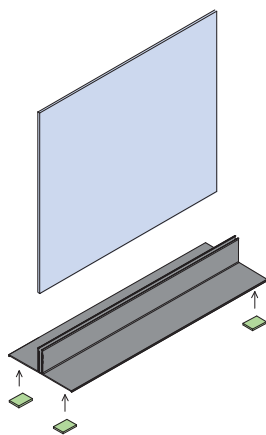

- Applicare feltri alla base del profilo, per maggiore sicurezza si consiglia di applicare anche il biadesivo
 - Attach the felt strips under the base, for more safety it is recommended to apply also the double-sided tape
 - Befestigen die Filzgleiter unter Profil. Für mehr Sicherheit wird empfohlen, auch das doppelseitige Klebeband anzubringen



SC-131

- Biadesivo 10 mt, spessore 1 mm
- Double-sided tape 10 m, 1 mm thickness
- Doppelseitiges Klebeband 10 m, 1 mm Dicke

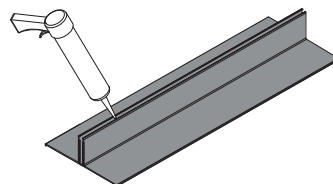

- Siliconare nella cava del profilo
 - Inject some silicone inside the channel
 - Silikon in das Profil einspritzen

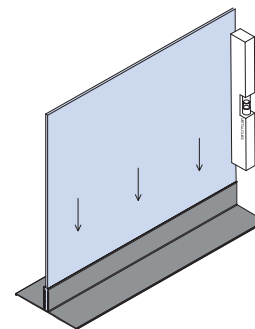

- Posizionare e infilare il vetro, controllare che il vetro sia a squadra
 - Arrange and insert the panel, check the alignment
 - Die Scheibe anbringen und einführen, Ausrichtung prüfen

Con biadesivo / with double-sided tape / mit doppelseitigem Klebeband

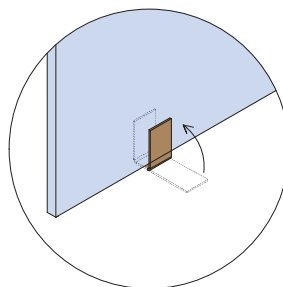

- Applicare le strisce di biadesivo (SC-131 non incluso) sul vetro e rimuovere la pellicola
 - Apply double-sided adhesive strips (SC-131 not included) and remove the film
 - Zur Befestigung von Klebestreifen das Klebeband abziehen und die selbstklebende Rückseite montieren (SC-131 nicht enthalten)

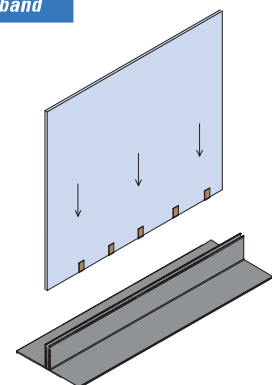
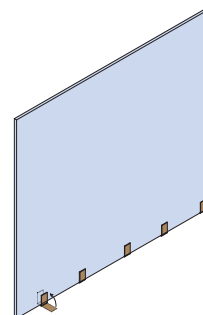

- Posizionare e infilare il vetro
 - Arrange and insert the panel
 - Die Scheibe anbringen und einführen