

PROFILI IN POLICARBONATO BIADESIVI POLYCARBONATE PROFILE WITH ADHESIVE / POLYCARBONATPROFILE SELBSTKLEBEND

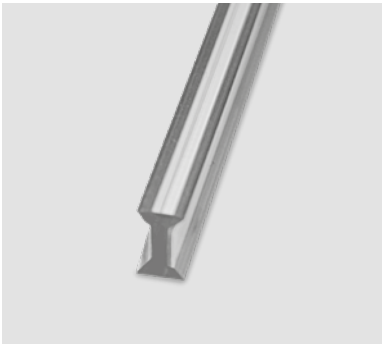

VP-21 [D.181](#)

- Profilo in policarbonato ad H per giunzione vetro 2 vie in linea con biadesivo 3M su ambo i lati
- H polycarbonate transparent profile with adhesive fixing for glass 10 mm
- H Polycarbonatprofil selbstklebend für Glas 10 mm

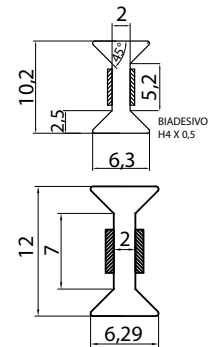

VP-22 [D.182](#)

- Profilo in policarbonato ad H per giunzione vetro 2 vie in linea con biadesivo 3M su ambo i lati. Profili in barre da 3 metri per spessore vetro 12 mm. e 5+5+1,52
- H polycarbonate transparent profile with adhesive fixing for glass 12 and 5+5+1,52 mm. Profile in bars of 3 mt
- H Polycarbonatprofil selbstklebend für Glas 12 und 5+5+1,52 mm

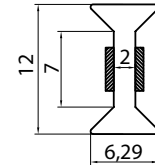

VP-23 [D.183](#)

- Profilo in policarbonato per giunzione vetro 2 vie a 90° con biadesivo 3M sui lati. Profili in barre da 3 metri per spessore vetro 10 mm. e 5+5+0,76
- 2 way joints polycarbonate transparent profile with adhesive fixing for glass 10 mm. and 5+5+0,76 mm.
- 2-Wege Polycarbonatprofil selbstklebend für Glas 10 mm und 5+5+0,76 mm.

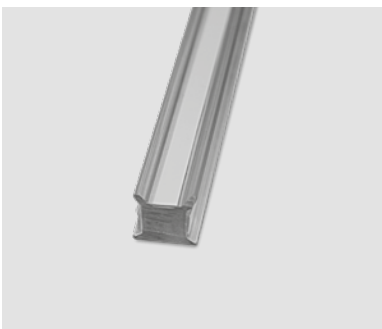
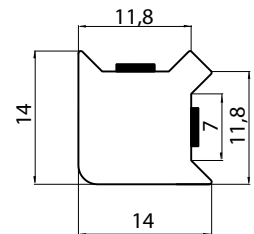

VP-24 [D.184](#)

- Profilo in policarbonato per giunzione vetro 3 vie con biadesivo 3M sui lati. Profili in barre da 3 metri per spessore vetro 10/12 mm. e 5+5+1,52
- 3 way joints polycarbonate transparent profile with adhesive fixing for glass 10/12 mm. and 5+5+1,52 mm.
- 3-Wege Polycarbonatprofil selbstklebend für Glas 10/12 mm und 5+5+1,52 mm.

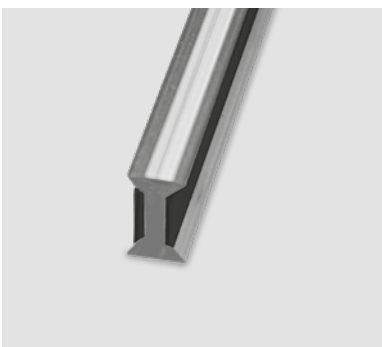
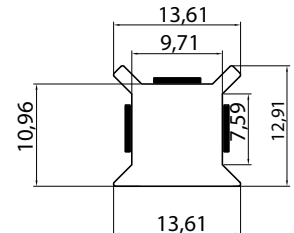

VP-40 [D.176](#)

- Profilo in policarbonato L = 3000 mm per spessore vetro 8 mm.
- Polycarbonate transparent profile L = 3000 mm for glass 8 mm.
- Transparent Profil in Polycarbonat L = 3000 mm für Glas 8 mm.

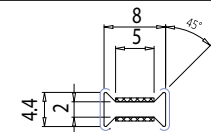

VP-41 [D.177](#)

- Profilo in policarbonato L = 3000 mm per spessore vetro 10 mm.
- Polycarbonate transparent profile L = 3000 mm for glass 10 mm.
- Transparent Profil in Polycarbonat L = 3000 mm für Glas 10 mm.

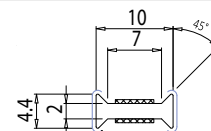

VP-42 [D.178](#)

- Profilo in policarbonato L = 3000 mm per spessore vetro mm 5+5+1,52 pvb.
- Polycarbonate transparent profile L = 3000 mm for glass mm 5+5+1,52 pvb.
- Transparent Profil in Polycarbonat L = 3000 mm für Glas mm 5+5+1,52 pvb.

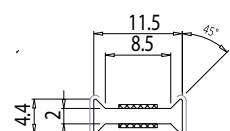

VP-43 [D.179](#)

- Profilo in policarbonato L = 3000 mm per spessore vetro 12 mm.
- Polycarbonate transparent profile L = 3000 mm for glass 12 mm.
- Transparent Profil in Polycarbonat L = 3000 mm für Glas 12 mm.

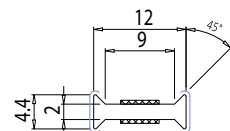

VP-44 [D.180](#)

- Profilo in policarbonato L = 3000 mm per spessore vetro mm 6+6+1,52 pvb.
- Polycarbonate transparent profile L = 3000 mm for glass mm 6+6+1,52 pvb.
- Transparent Profil in Polycarbonat L = 3000 mm für Glas mm 6+6+1,52 pvb.

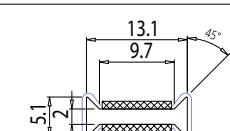

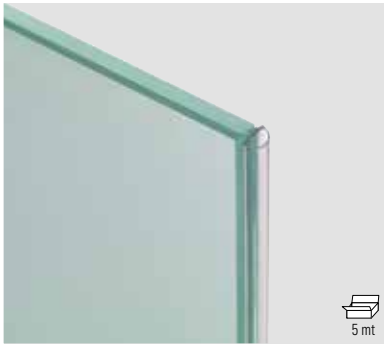

5 mt

WRU-M 80/50 MT5 **D.187**

- Guarnizione neutra per vetro 8 mm, fissaggio adesivo.
- Neutral gasket for glass 8 mm, with adhesive fixing.
- Dichtungsprofil für 8 mm Glas, selbstklebend

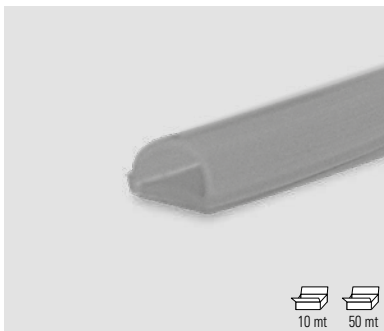
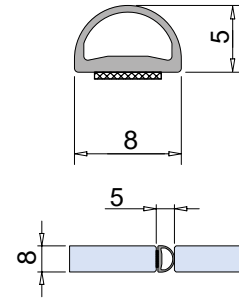

10 mt 50 mt

WRU-S60/40R **D.186**

- Guarnizione neutra per vetro 8 mm. con fissaggio adesivo
- Neutral gasket for glass 8 mm. with adhesive fixing
- Dichtungsprofil für 8 mm Glaskante selbstklebend.

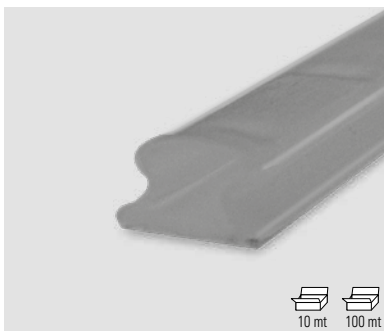
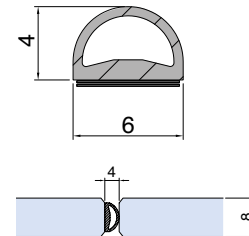

10 mt 100 mt

WRU-S100/60Z **D.185**

- Guarnizione neutra per vetro 10-12 mm. con fissaggio adesivo
- Neutral gasket for glass 10-12 mm. with adhesive fixing
- Dichtungsprofil für 10/12 mm Glaskante selbstklebend.

