

DISTANZIALI ORBITALI

ORBITAL POINT FITTINGS / PUNKTHALTERUNGEN



DR-048-30 € 1.46

- Distanziale orbitale con tappo piano Ø 48 per vetri da 13,5 e 17,52 mm.
- Point fitting Ø 48 with regulation. For glass 13,5 and 17,52 mm.
- Punkthalter Ø 48 verstellbar. Für Glas 13,5 und 17,52 mm.

IX
Materiale / Material / Material:
Inox AISI 316

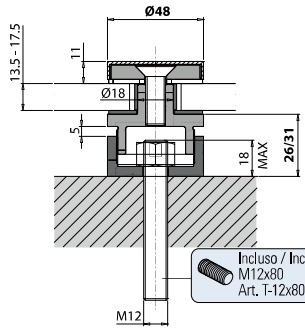

8+8+1.52
6+6+1.52

Foro nel vetro
Glass hole
Glas Bohrungen

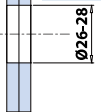

Incluso / Included / Inkl.
M12x80
Art. T-12x80

- Regolazione in profondità con vetro montato.
- Depth adjustment with installed glass.
- Tiefeneinstellung mit eingebautem Glas.

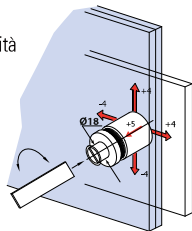

XFB-043



DR-048-35 € 1.47

- Distanziale orbitale con tappo piano Ø 48 per vetri da 21,5 e 25,52 mm.
- Point fitting Ø 48 with regulation. For glass 21,5 and 25,52 mm.
- Punkthalter Ø 48 verstellbar. Für Glas 21,5 und 25,52 mm.

IX
Materiale / Material / Material:
Inox AISI 316

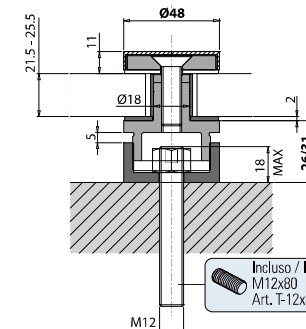

12+12+1.52
10+10+1.52

Foro nel vetro
Glass hole
Glas Bohrungen

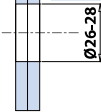

Incluso / Included / Inkl.
M12x80
Art. T-12x80

- Regolazione in profondità con vetro montato.
- Depth adjustment with installed glass.
- Tiefeneinstellung mit eingebautem Glas.

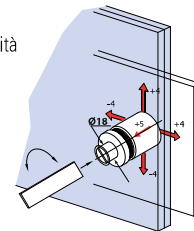

XFB-043



DR-048-50 € 1.48

- Distanziali orbitali con tappo piano Ø 48.
- Point fittings Ø 48 with regulation.
- Punkthalter Ø 48 Verstellbar.

IX
Materiale / Material / Material:
Inox AISI 316

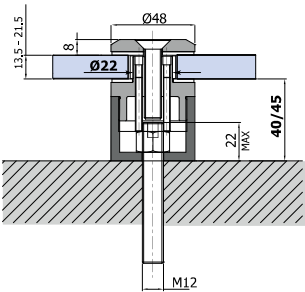

10+10+1.52
8+8+1.52
6+6+1.52

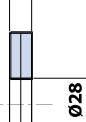

T-12x150 € 1.50

- Non incluso
- Not included

CHIAVE DR-48 € 1.49

- Chiave per regolazione in profondità con vetro montato
- Tool depth adjustment with installed glass
- Schlüssel Tiefeneinstellung mit eingebautem Glas



- Regolazione in profondità con vetro montato.
- Depth adjustment with installed glass.
- Tiefeneinstellung mit eingebautem Glas.

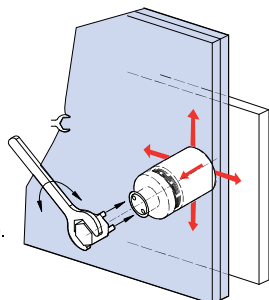

xfb031



DR-048-55 N € 1.51

- Distanziali orbitali con tappo piano Ø 48.
- Point fittings Ø 48 with regulation.
- Punkthalter Ø 48 Verstellbar.

IX
Materiale / Material / Material:
Inox AISI 316

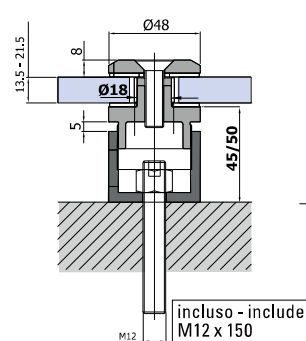

10+10+1.52
8+8+1.52
6+6+1.52

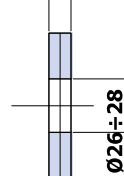

incluso - included
M12 x 150

- Regolazione in profondità con vetro montato.
- Depth adjustment with installed glass.
- Tiefeneinstellung mit eingebautem Glas.

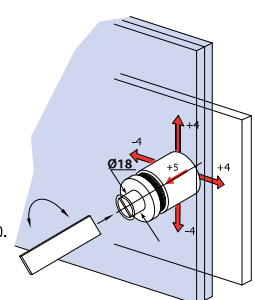

xfb033-a



**D-050-10 / D-050-60
D-050-80**

- Distanziale Ø 50 con collo.
- Point fittings Ø 50 with support.
- Punkthalter Ø 50 mit Hals.

IX

€ 1.52

D-050-10

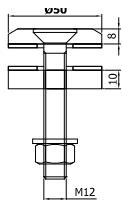

D-050-60

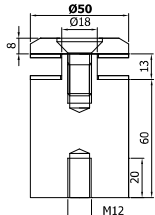

D-050-80

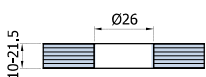
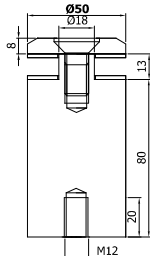

Incluso / Included / Inkl.
M12x80

Incluso / Included / Inkl.
M12x30

xme233-A



**D-040-10 / D-040-25
D-040-45 / D-040-60
D-040-80 / D-040-100**

- Distanziale Ø 40 con collo.
- Point fittings Ø 40 with support.
- Punkthalter Ø 40 mit Hals.

IX

€ 1.53

D-040-10

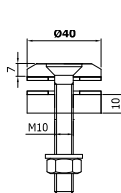

D-040-25
(ex V-057)

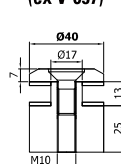

D-040-45
(ex V-051)

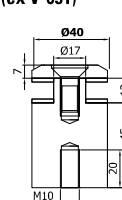

D-040-60

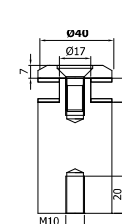

D-040-80

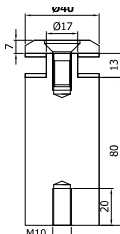

D-040-100

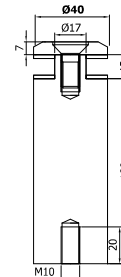

Incluso / Included / Inkl.
M10x150

Incluso / Included / Inkl.
M10x30

V-10x25
Optional für Glas 10...12,7
Optional per vetro 10...12,7
Optional for glass 10...12,7

€ 1.54

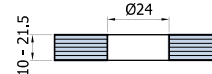

xme233-A



TA-051-CF2 (optional)

- Tappo coprivite Ø 40, tappo interno filettato e vite M10.
- Cover cup Ø 40 with threaded disk.
- Abdeckung Ø 40 mit Gewinderosette.

IX

€ 1.55

2 pcs



TA-052-CF4 (optional)

- Tappo coprivite Ø 30, tappo interno filettato e vite M10.
- Cover cup Ø 30 with threaded disk.
- Abdeckung Ø 30 mit Gewinderosette.

IX

€ 1.56

4 pcs



TA-048-CF2 (optional)

- Tappo coprivite Ø 48 x H 9, tappo interno filettato e vite M10.
- Cover cup Ø 48 x H 9 with threaded disk.
- Abdeckung Ø 48 x H 9 mit Gewinderosette.

IX

€ 1.81

2 pcs

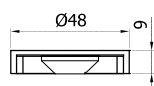
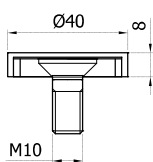
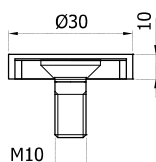

xme233-A



**DP-044-10 / DP-044-20
DP-044-30 / DP-044-40
DP-044-60 / DP-044-70
DP-044-100**

- Distanziale modulare con tappo piano Ø 45 con spessori.
- Point fittings Ø 45 with spacers.
- Punkthalter Ø 40 mit Verlängerungen.

IX

€ 1.59

DP-044-10

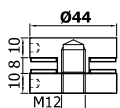

DP-044-20

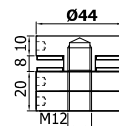

DP-044-30

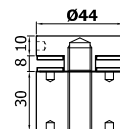

DP-044-40

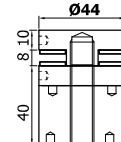

DP-044-60

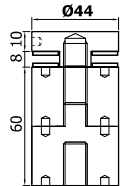

DP-044-70

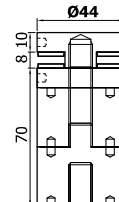

DP-044-100

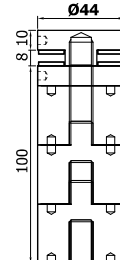

Incluso / Included / Inkl.
M12x40

Incluso / Included / Inkl.
M12x150

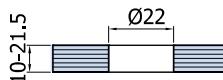

xme233-I



D-030-10 / D-030-20
D-030-30 / D-030-40

- Distanziale Ø 30 con collo.
- Point fittings Ø 30 with support.
- Punkthalter Ø 30 mit Hals.

IX

€ ▶ 1.57



D-016-10 / DS-016-10

- Distanziale Ø 16 senza collo.
- Point fittings Ø 16 without support.
- Punkthalter Ø 16 ohne Hals.

IX

€ ▶ 1.58

D-030-10

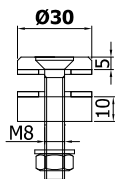

D-030-20

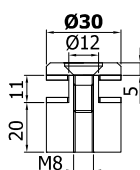

D-030-30

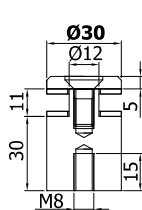

D-030-40

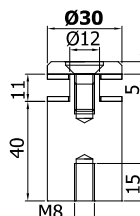

Incluso / Included / Inkl. M8x120

Incluso / Included / Inkl. M8x25

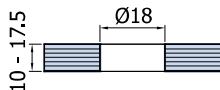

xme233-B

D-016-10

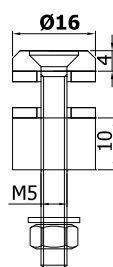

DS-016-10

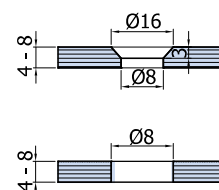
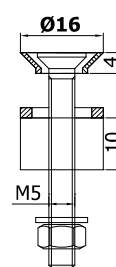

Incluso / Included / Inkl. M5x40

xme233-B