

SESAMO

V-2000

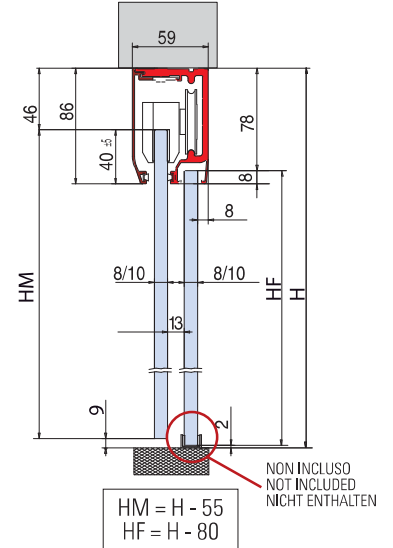

SIMPLE

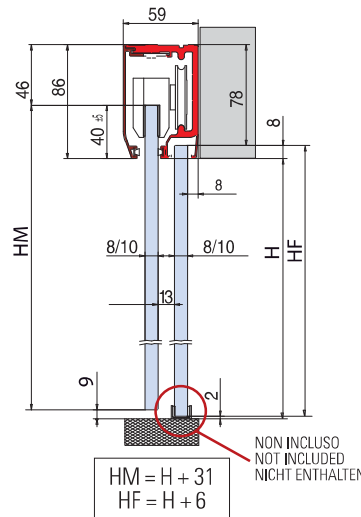
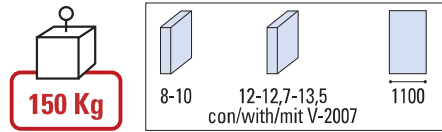

V-2000 SET 1

€▶A.188

- Set per 1 anta scorrevole, fissaggio a parete/soffitto
- Sliding door set, wall/ceiling installation
- Schiebetürset 1-flügelig, Wand-Deckenmontage

V-2000 SET 3

€▶A.189

- Set per 1 anta scorrevole e vetro fisso, fissaggio a parete/soffitto
- Sliding door set with fixed panel, wall/ceiling installation
- Schiebetürset 1-flügelig mit Seitenteil, Wand-Deckenmontage

LAVORAZIONE VETRO GLASS PREPARATION GLASBEARBEITUNG

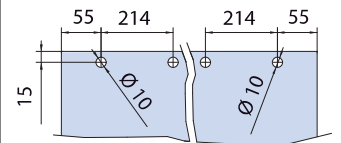

- Fori **optional**
- Holes **optional**
- Bohrungen **optional**

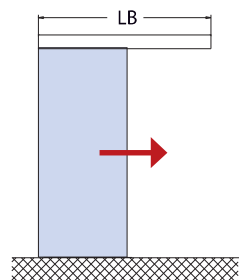
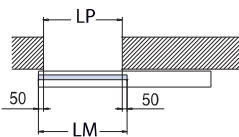

$$LB = LP \times 2 + 150$$

$$LM = LF = LP + 100$$

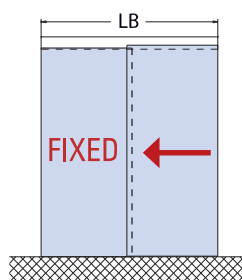
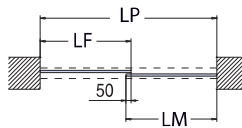

$$LB = LP$$

$$LM = LF = (LP + 50) / 2$$

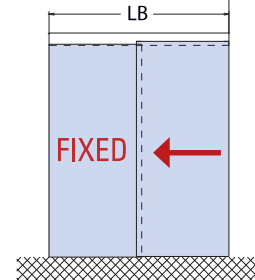
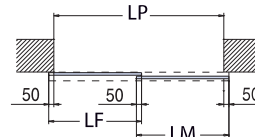

$$LB = LP + 100$$

$$LM = LF = (LP + 150) / 2$$

xl50 / pla169x2

COMPONENTI / COMPONENTS / EINZELTEILE

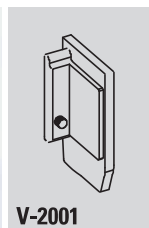

OPTIONAL		<ul style="list-style-type: none"> • Guarnizioni per sede vetro fisso • Gaskets for fixed glass • Dichtungen für Seitenteil
VP-019-MT	VP-018-MT	
1000 mm	3	
2000 mm	3	
3000 mm	3	

Cod.	Fin. / Fin. / Oberf.	V-2000 SET 1 FIX	V-2000 SET 1-MIS	V-2000 SET 3 FIX	V-2000 SET 3-MIS
V-2000 L=2000 L=3000 L=4000 L=6000	AN	1	-	1	-
V-2000-MIS L=1500 → 6000	AN	-	1	-	1
V-2002	-	1	1	1	1
V-012	AN	1	1	1	1
V-2001	AN	1	1	(1) (OPTIONAL)	(1) (OPTIONAL)

V-2000 SESAMO

COMPONENTI / COMPONENTS / EINZELTEILE

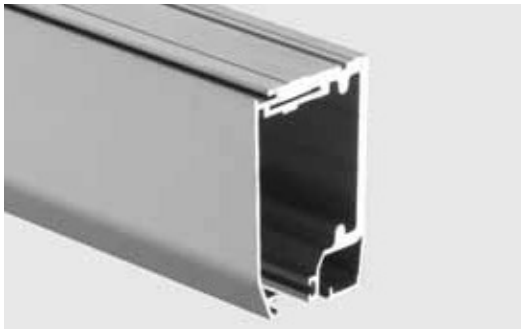

- V-2000**
- Binario Sesamo
 - Track profile Sesamo
 - Laufschiene Sesamo

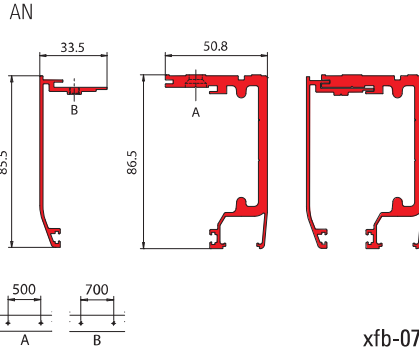

€▶A.190

€▶A.197

OPTIONAL	
VP-019-MT	VP-018-MT
2	3
1000 mm - 2000 mm - 3000 mm	
<ul style="list-style-type: none"> • Guarnizioni per sede vetro fisso • Gaskets for fixed glass • Dichtungen für Seitenteil 	
8	10
12	12



SIMPLE



- V-2002**
- Set carrelli con pinze e stopper per 1 anta scorrevole
 - Set roller carriers and stoppers for 1 panel
 - Set Klemm-Laufwagen und stopper für 1 Flügel

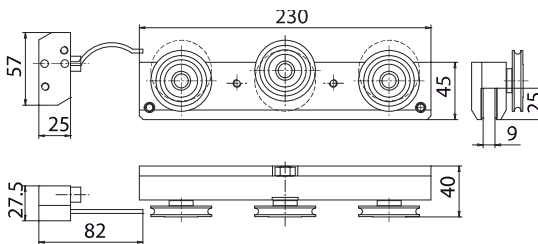

€▶A.191

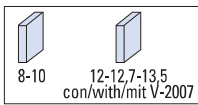

150 Kg

xfb-074

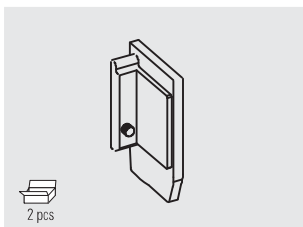

- V-2001**
- Paio tappi finali in alluminio per guida a scorrimento V-2000
 - Pair aluminium endcaps for track profile V-2000
 - Paar Endkappen aus Aluminium für Laufschiene V-2000
- AN

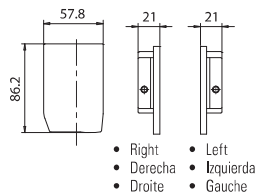

€▶A.195



- V-2007**
- Set per spessori vetro 12 - 12,7 - 13,5 (per 2 pinze V-2002)
 - Set spacers for glass thickness 12 - 12,7 - 13,5 (for 2 clamps V-2002)
 - Set distanzscheiben für Glasdicke 12 - 12,7 - 13,5 (für 2 Klemm-Laufwagen V-2002)

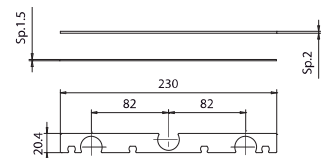
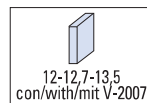

€▶A.192

xfb-074

- V-2014-MIX**
- Canalina per vetro fisso escluso guarnizioni
 - U channel for fixed panel, gaskets not included
 - U Profil für Seitenteil Dichtungen nicht inkl
- AN - IXE

€▶A.196

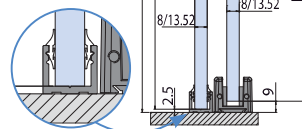
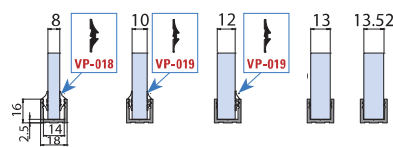

Cod.	Fin./Fin./Oberf.
V-2014-2000 mm	AN / IXE / NO
V-2014-3000 mm	AN / IXE / NO
V-2014-6000 mm	AN / IXE / NO

- V-2010**
- Set per la chiusura simultanea di due ante scorrevoli per il sistema Sesamo V-2000
 - Set for 2-panel synchronously opening system for Sesamo V-2000
 - Set für 2-flügelige synchron öffnende Schiebetüren für Sesamo V-2000

€▶A.194

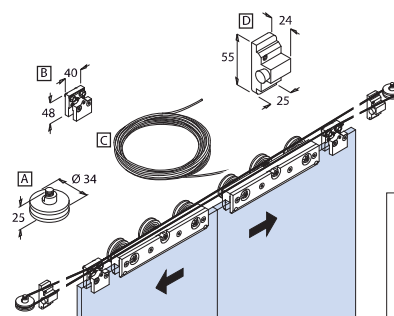

xla050